

Quick Coupling Selection Guide

1. Determine the profile (shape) of the plug. Compare your plug shape with the profile chart below to identify the Dixon Quick Coupling pneumatic or hydraulic series.

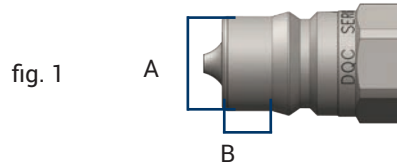

2. Body size dimension charts can be found within each series section. Measure the **A** (diameter) and **B** (tip length) dimensions to determine the plug body size (figure 1).



















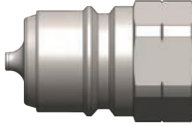





3. Use the industry standard thread chart below (or diagram on page 6) to determine the end connection thread size. If you have a hose barb, the ID measurement of your hose will determine the barb size (figure 2).

Actual Thread OD or ID	3/8"	1/2"	5/8"	3/4"	1"	1-3/8"	1-5/8"	1-29/32"	2-3/8"
Nominal Thread Size	1/8"	1/4"	3/8"	1/2"	3/4"	1"	1-1/4"	1-1/2"	2"

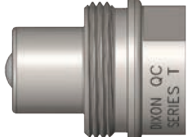
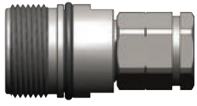

Pneumatic Profile Shape		DF-Series steel • brass • 303 ss	J-Series steel • brass	M-Series steel • brass
		Industrial Interchange page 20	Automotive page 30	ARO 210-310 page 35
CJ-Series steel • brass	SHD-Series steel • aluminum	L-Series steel • brass	U-Series brass	N-Series steel • brass • 303 ss • 316 ss
High-Flow page 39	Twist-Lock page 42	Lincoln page 45	Universal Air page 47	Bowes / Dix-Lock® page 49
P-Series steel • brass • 303 ss	NK-Series steel	BR-Series brass	A-Series steel • brass	SCV-Series brass
Thor / Dual-Lock page 57	Japanese Industrial page 61	21 Series page 63	Compact page 65	Safety Check Valve page 68

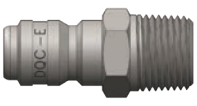
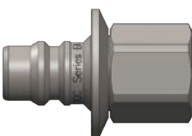
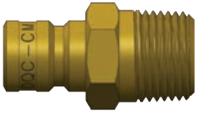
<p>Hydraulic Profile Shape</p> 	<p>H-Series steel • brass • 303 ss • 316 ss</p>  <p>ISO7241-B page 70</p>	<p>H-BOP-Series steel • 316 ss</p>  <p>ISO7241-B BOP page 80</p>	<p>HS-Series steel • brass • 303 ss</p>  <p>ISO7241-B Steam page 82</p>	<p>CNG-Series 303 ss</p>  <p>Oasis 300 page 85</p>
<p>K-Series steel • 316 ss</p>  <p>ISO7241-A page 87</p>	<p>AG-Series steel</p>  <p>Agricultural page 93</p>	<p>V-Series steel • brass • 316 ss</p>  <p>MIL-C-51234 page 98</p>	<p>TR-Series steel</p>  <p>European page 115</p>	<p>HT-Series steel • 316 ss</p>  <p>Correct Connect® ISO16028 page 117</p>
<p>HTE-Series steel</p>  <p>ISO16028 Connect Under Pressure Plug pages 125</p>	<p>HTZ-Series steel</p>  <p>ISO16028 Connect Under Pressure Coupler page 128</p>	<p>HT-AG-Series steel</p>  <p>ISO16028 - AG ISO7241-A page 129</p>	<p>XK-Series steel</p>  <p>10K Flushface page 130</p>	<p>ST-Series steel • 316 ss</p>  <p>Heavy-Duty Flushface page 132</p>
<p>PD-Series steel</p>  <p>ISO15171-1 Test page 138</p>	<p>VEP-Series steel • 316 ss</p>  <p>Threaded Flushface page 140</p>	<p>VEP-BOP-Series steel</p>  <p>Threaded Flushface BOP page 145</p>	<p>W-Series steel • brass</p>  <p>Wingstyle page 147</p>	<p>WS-Series steel • 316 ss</p>  <p>Heavy-Duty Wingstyle page 152</p>
<p>WS-BOP-Series steel • 316 ss</p>  <p>Heavy-Duty Wingstyle BOP page 158</p>	<p>T-Series steel • 316 ss</p>  <p>10K Threaded page 160</p>	<p>CVV-Series steel</p>  <p>Euro-Threaded ISO14541 page 163</p>	<p>TD-Series 316 ss</p>  <p>15K and 20K Threaded page 167</p>	<p>E-Series steel • brass • 303 ss</p>  <p>Straight-Through page 169</p>
<p>EA-Series steel</p>  <p>Water Blast page 175</p>	<p>CM-Series brass and steel</p>  <p>Mold Coolant page 177</p>			

Cross Reference Tool

Competitor Series or Standard	Manufacturer	Dixon Series	Page(s)
10000-Series	TEMA	TR-Series	115
1000-Series	Hansen	F-Series	20
10-Series	Parker	J-Series	30
1110-Series	Tomco	L-Series	45
13-Series	Rectus	NK-Series	61
20-Series	Parker	F-Series	20
210/310	Foster	M-Series	35
210/310	Hansen	M-Series	35
210/310	Milton	M-Series	35
21KA	Rectus	BR-Series	63
223-Series	CEJN	BR-Series	63
25KA	Rectus	CJ-Series	39
26KA	Rectus	CJ-Series	39
27KA	Rectus	CJ-Series	39
3000-Series	Hansen	D-Series	20
3000-Series	Parker/Pioneer	T-Series	160
30-Series	Parker	D-Series	20
300-Series	Oasis	CNG-Series	85
315-Series	CEJN	NK-Series	61
320-Series	CEJN	CJ-Series	39
3800-Series	TEMA	TR-Series	115
3FFH-Series	Faster	HTE-Series	125
3-Series	Foster	DF-Series	20
4000 Series	Parker/Pioneer	AG-Series	93
4000-Series	Hansen	D-Series	20
400-Series	Hansen	F-Series	20
410-Series	CEJN	CJ-Series	39
4-Series	Foster	DF-Series	20
5000-Series	Hansen	D-Series	20
5000-Series	TEMA	TR-Series	115
500-Series	Hansen	F-Series	20
50-Series	Parker	M-Series	35
51000-Series	Bowes	N-Series	49
5100-Series	Eaton/Aeroquip	W-Series	147
525-Series	CEJN	TR-Series	115
55KM	Rectus	J-Series	30
56-Series	Snap-Tite	EA-Series	175
5-Series	Foster	DF-Series	20
5TV/6TV-Series	Hydraulics Inc	WS-Series	152
6000-Series	Hansen	D-Series	20

Competitor Series or Standard	Manufacturer	Dixon Series	Page(s)
60-Series	Parker	H-Series	70
60-Series	Snap-Tite	AG-Series	93
60-Series Steam	Parker	HS-Series	82
6100-Series	Foster	W-Series	147
6100-Series	Parker	W-Series	147
61-Series	Snap-Tite	K-Series	87
6600-Series	Parker	K-Series	87
6-Series	Foster	DF-Series	20
70-Series	Parker	L-Series	45
71-Series	DNP	ST-Series	132
71-Series	Snap-Tite	ST-Series	132
72-Series	Snap-Tite	H-Series	70
74-Series	Snap-Tite	HT-Series	117
7500-Series	TEMA	TR-Series	115
75-Series	Snap-Tite	WS-Series/ WS-BOP- Series	152 and 158
76-Series	Snap-Tite	T-Series	160
78-Series	Snap-Tite	W-Series	147
A2100/PT400	Tomco	J-Series	30
A-A-50431A	U.S. Government	N-Series	49
A-A-59439	U.S. Government	DF-Series	20
ANV-Series	DNP	K-Series	87
ANV-Series	Faster	K-Series	87
APM-Series	Stucchi	HTE-Series	125
ARO	Interchange	M-Series	35
A-Series	National	P-Series	57
A-Series	Stucchi	HT-Series	117
Auto-Flo 23	Hansen	U-Series	47
Automotive	Interchange	J-Series	30
BIR-Series	Stucchi	K-Series	87
Bowes	Interchange	N-Series	49
B-Series	National	N-Series	49
C604	Enerpac	T-Series	160
Correct Connect®	Trademark	HT-Series	117
CQD-Series	Spir Star	TD-Series	167
CRS-Series	DNP	TD-Series	167
CS-Series	Nycoil	SHD-Series	42
CVV-Series	Faster	CVV-Series	163
Dixlock	Trademark	N-Series	49

Competitor Series or Standard	Manufacturer	Dixon Series	Page(s)
Double Lock	Campbell	P-Series	57
D-Series	DNP	PD-Series	138
Dual-Lock	Trademark	P-Series	57
European Screw-Together	Interchange	CVV-Series	163
European	Nycoil	CJ-Series	39
European High-Flow	Interchange	CJ-Series	39
FB-Series	Faster	W-Series	147
FD45	Eaton/Aeroquip	H-Series	70
FD56 (5600) Series	Eaton/Aeroquip	K-Series	87
FD69-Series	Eaton/Aeroquip	EA-Series	175
FD85-Series	Eaton/Aeroquip	WS-Series	152
FD89-Series	Eaton/Aeroquip	HT-Series	117
FD90-Series	Eaton/Aeroquip	PD-Series	138
FD96-Series	Eaton/Aeroquip	VEP-Series	140
FEC-Series	Parker	HTE-Series	125
FEM-Series	Parker	HT-Series	117
FET-Series	Parker	VEP-Series	140
FF49-Series	Safeway	HT-Series	117
FFEC49-Series	Safeway	HTE-Series	125
FF-GP Series	DNP	HT-Series	117
FFK-Series	DNP	HTE-Series	125
FFN/FFI/2FFN/2FFI	Faster	HT-Series	117
FF-Series	Hansen	HT-Series	117
FF-Series	Parker	HT-Series 3/8" only	117
FHK-Series	Foster	H-Series	70
FH-Series	Voswinkel	HTE-Series	125
FIH/FH	Foster	V-Series	98
FIRG	Stucchi	HT-Series	117
FJT-Series	Foster	CM-Series	177
Flo-Temp	Hansen	CM-Series	177
FSI-BOP-Series	DNP	VEP-BOP-Series	145
FS-Series	Hansen	SCV-Series	68
FST-Series	Foster	E-Series	169
FT-Series	Voswinkel	VEP-Series	140
FVEP-Series	Foster	VEP-Series	140
H/IH-Series	Snap-Tite	V-Series	98
HA15000	Hansen	K-Series	87
HCP-Series	Holmbury	HTE-Series	125

Competitor Series or Standard	Manufacturer	Dixon Series	Page(s)
HFB-Series	Holmbury	E-Series	169
HFT-Series	Holmbury	VEP-Series	140
High Pressure Screw-Together	Interchange	T-Series	160
HKFR-Series	Eaton/Hansen	H-BOP-Series	80
HK-Series	Hansen	H-Series	70
HNV-BOP-Series	DNP	H-BOP-Series	80
HNVFR-Series	Faster	H-BOP-Series	80
HNV-Series	DNP	H-Series	70
HNV-Series	Faster	H-Series	70
HQ-Series	Holmbury	HT-Series	117
HSS-Series	Holmbury	HT-Series	117
HTN-Series	Holmbury	V-Series	98
IA/IAZ-Series	Holmbury	K-Series	87
IA-Series	Voswinkel	K-Series	87
IB/IBZ-Series	Holmbury	H-Series	70
IB-Series	Voswinkel	H-Series	70
Industrial	Interchange	DF-Series	20
IRB/IRBO/IRBX Series	Stucchi	H-Series	70
IRC-Series	Stucchi	TR-Series	115
IR-Series	Stucchi	AG-Series	93
ISO14540	ISO Standard	T-Series	160
ISO14541	ISO Standard	CVV-Series	163
ISO15171-1	ISO Standard	PD-Series	138
ISO16028	ISO Standard	HT-Series	117
ISO5675	ISO Standard	AG-Series	93
ISO6150B	ISO Standard	DF-Series	20
ISO7241-A	ISO Standard	K-Series	87
ISO7241-B	ISO Standard	H-Series	70
IVHP-Series	Stucchi	T-Series	160
Japanese Industrial	Interchange	NK-Series	61
JS-Series	DME	CM-Series	177
LC-Series	Holmbury	WS-Series	152
Lincoln	Interchange	L-Series	45
MC-Series	Tomco	CM-Series	177
Megaflow	Coilhose	CJ-Series	39
MIL-C-3486	Military Spec	N-Series	49
MIL-C-4109F	Military Spec	DF-Series	20

Cross Reference Tool

Competitor Series or Standard	Manufacturer	Dixon Series	Page(s)
Mil-C-51234	Military Spec	V-Series	97
Mold Coolant	Interchange	CM-Series	177
Moldmate	Parker	CM-Series	177
MPX-Series	Staubli	HT-Series	117
MQS-A Series	Manuli	K-Series	87
MQS-B Series	Manuli	H-Series	70
MQS-D Series	Manuli	PD-Series	138
MQS-F Series	Manuli	HT-Series	117
MQS-FP Series	Manuli	HTE-Series	125
MQS-SC Series	Manuli	T-Series	160
Ni-Cupla	Nitto Kohki	NK-Series	61
NS-Series	DNP	AG-Series	93
NS-Series	Faster	AG-Series	93
NS-Series/Jiffy-Tite	DME	CM-Series	177
NV-Series	Faster	AG-Series	93
OGF-Series	Faster	ST-Series	132
OGVFR-Series	Faster	WS-BOP-Series	158
OGV-Series	Faster	WS-Series	152
PD-Series	Parker	PD-Series	138
PHC-Series	Thor	P-Series	57
Pioneer Agricultural	Interchange	AG-Series	93
PSB/PSP-Series	Holmbury	T-Series	160
PST4/FSI Series	DNP	VEP-Series	140
PVM-Series	DNP	T-Series	160
PVV3-Series	DNP	CVV-Series	163
PVV3-Series	DNP	CVV-Series	163
PVVM/PVSM-Series	Faster	T-Series	160
Quick-Action	MacDonald	N-Series	49
S10-Series	Safeway	H-Series	70
S20-Series	Safeway	AG-Series	93
S30-Series	Safeway	T-Series	160
S51-Series	Safeway	W-Series	147
S56-Series	Safeway	K-Series	87
Schrader	Interchange	SHD-Series	42
Screw Type	Jet Stream	TD-Series	167
SC-Series	Tomco	BR-Series	63
SHD-Series	Foster	SHD-Series	42
SH-Series	Stucchi	V-Series	98
Single Lock	Campbell	N-Series	49

Competitor Series or Standard	Manufacturer	Dixon Series	Page(s)
STG-Series	Inteva	CVV-Series	163
Straight-Through	Interchange	E-Series	169
ST-Series	DNP	E-Series	169
ST-Series	Hansen	E-Series	169
ST-Series	Parker	E-Series	169
ST-Series	Tomco	E-Series	169
TEMA European	Interchange	TR-Series	115
TF-Series	Foster	J-Series	30
Thor	Interchange	P-Series	57
TL-Series	Parker	SHD-Series	42
TL-Series	Tomco	SHD-Series	42
TNL-Series	Faster	V-Series	98
TNV-Series	DNP	V-Series	98
TNV-Series	Faster	V-Series	98
Tru-Flate	Eaton/Hansen	J-Series	30
Tru-Flate	Hoffmann	J-Series	30
Twist-Lock	Schrader	SHD-Series	42
Type B	Amflo	M-Series	35
Type-17	Coilhose	L-Series	45
Type-HS	Voswinkel	CVV-Series	163
UC-Series	Coilhose	U-Series	47
UC-Series	Parker	U-Series	47
VD-Series	Stucchi	CVV-Series	163
VEP-HD Series	Stucchi	VEP-Series/ VEP-BOP-Series	140 and 145
VEP-P Series	Stucchi	VEP-Series/ VEP-BOP-Series	140 and 145
VFF-HD BOP-Series	DNP	WS-BOP-Series	158
VFF-HD Series	DNP	WS-Series	152
VFF-Series	DNP	W-Series	147
VOF-Series	Stucchi	WS-Series	152
Water-Blast	Interchange	EA-Series	175
WB-Series	DNP	EA-Series	175
WB-Series	Parker	EA-Series	175
Wing Style	Stucchi	W-Series	147
WS56000	Hansen	T-Series	160
WSC-Series	Holmbury	W-Series	147
X64-Series	CEJN	HTE-Series	125
X65/X66-Series	CEJN	HT-Series	117

Male / Female Pipe (NPTF) Thread Identification

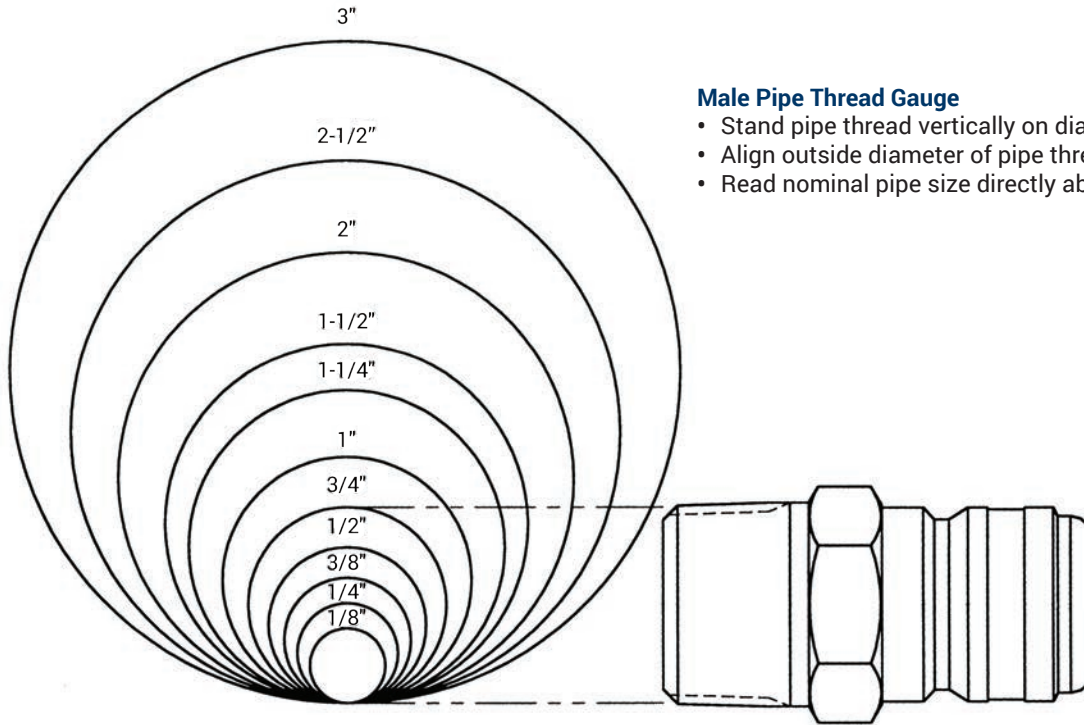

Male Pipe Thread Gauge

- Stand pipe thread vertically on diagram
- Align outside diameter of pipe thread with matching circle
- Read nominal pipe size directly above circle

Example: 3/4" male pipe
(Dixon end size = 6)

Female Pipe Thread Gauge

- Hold pipe thread against scale on edge of page
- Align one side of pipe thread with illustration base line
- Read nominal pipe size directly from scale

Nominal Pipe Size (inches)	Dixon End Size	Nominal Thread Size (inches)	Nominal Pipe Size (inches)
1/8	1	1/8 - 27	0.41
1/4	2	1/4 - 18	0.54
3/8	3	3/8 - 18	0.68
1/2	4	1/2 - 14	0.84
3/4	6	3/4 - 14	1.05
1	8	1-11 - 1/2	1.32
1-1/4	10	1-1/4 - 11-1/2	1.66
1-1/2	12	1-1/2 - 11-1/2	1.90
2	16	2 - 11-1/2	2.38
2-1/2	20	2-1/2 - 8	2.88
3	24	3 - 8	3.50

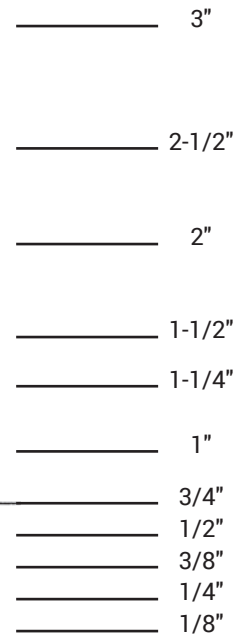

Example: 3/4" female pipe
(Dixon end size = 6)

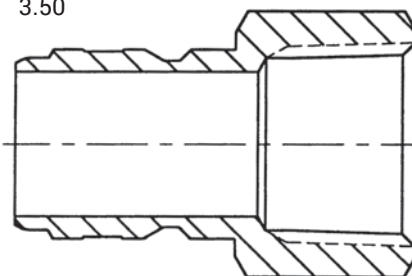

Base line for all sizes

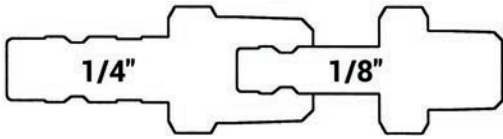

A-Series

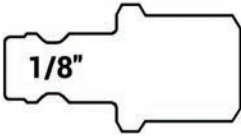

BR-Series

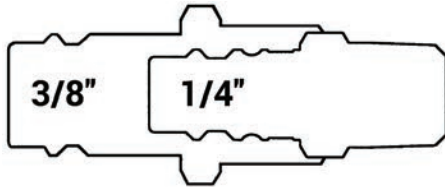

CJ-Series

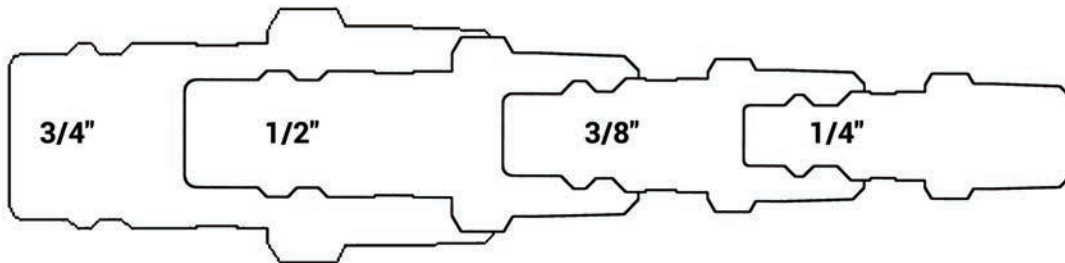

DF-Series

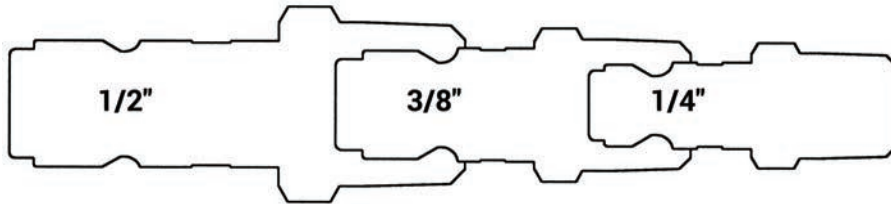

J-Series

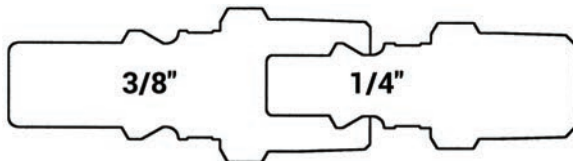

M-Series



L-Series

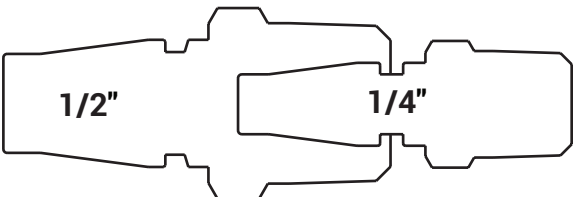

SHD-Series

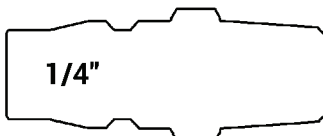

NK-Series

K-Series

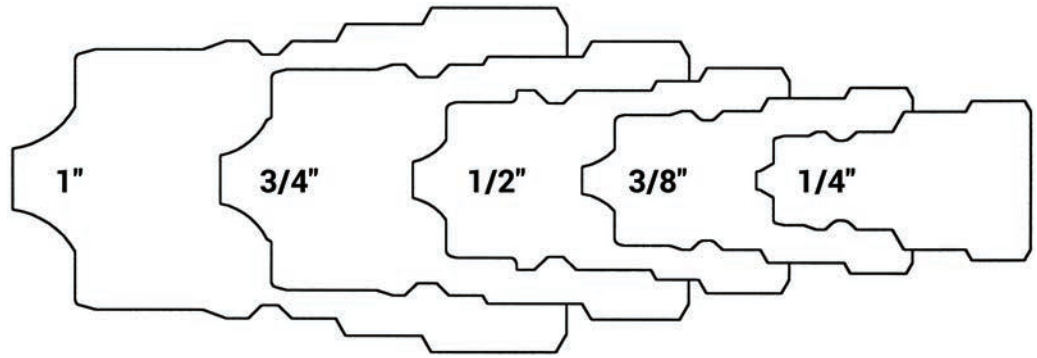

Large K-Series

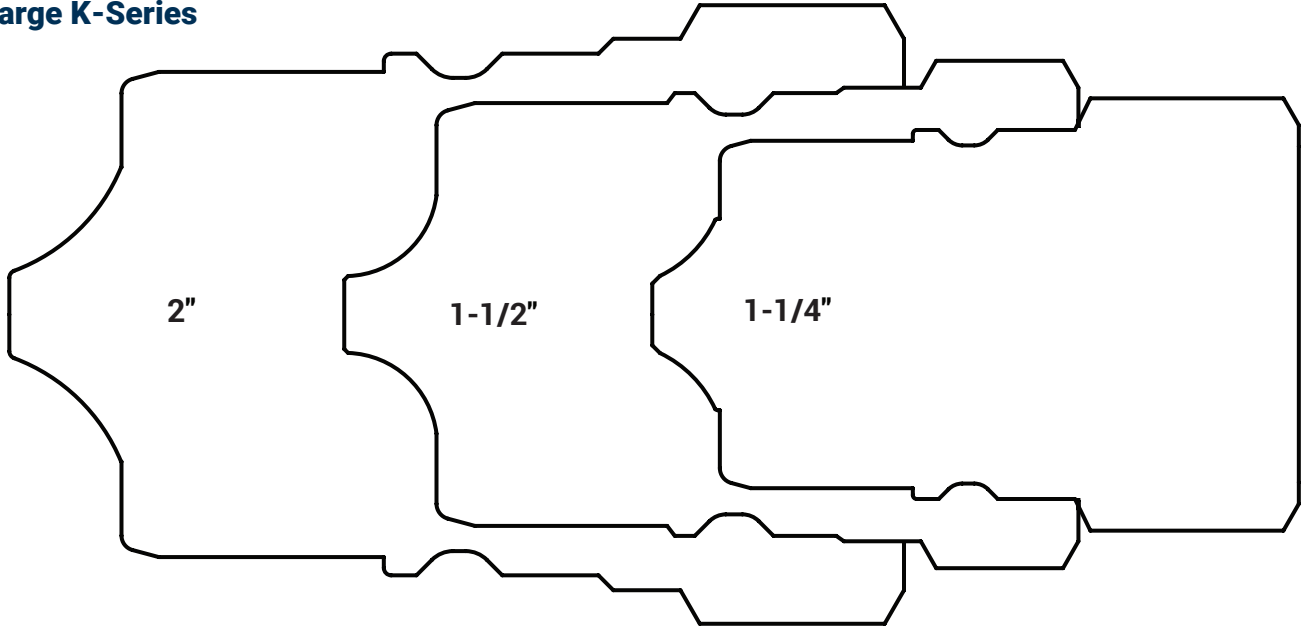

AG-Series

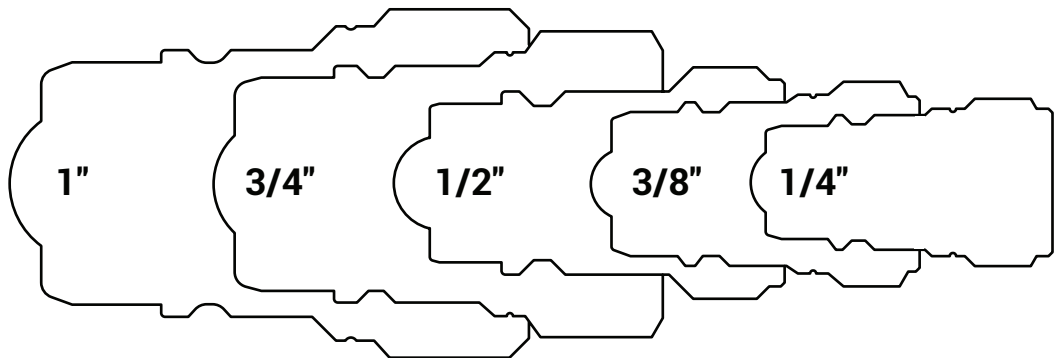

TR-Series

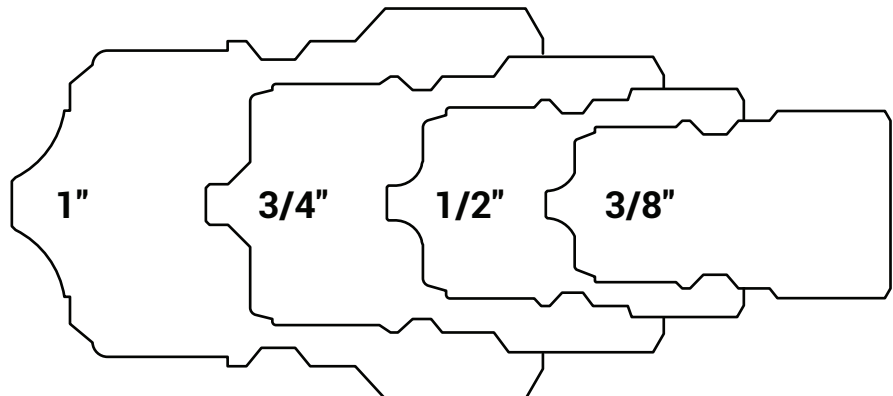

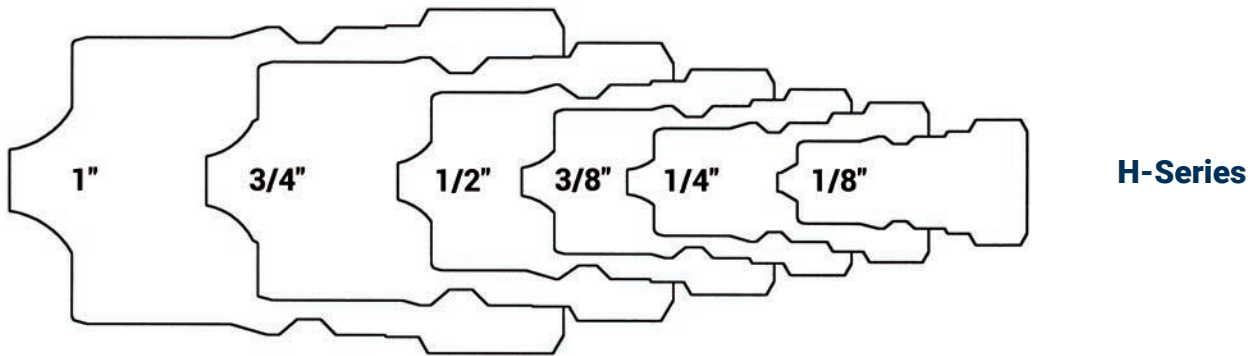

H-Series

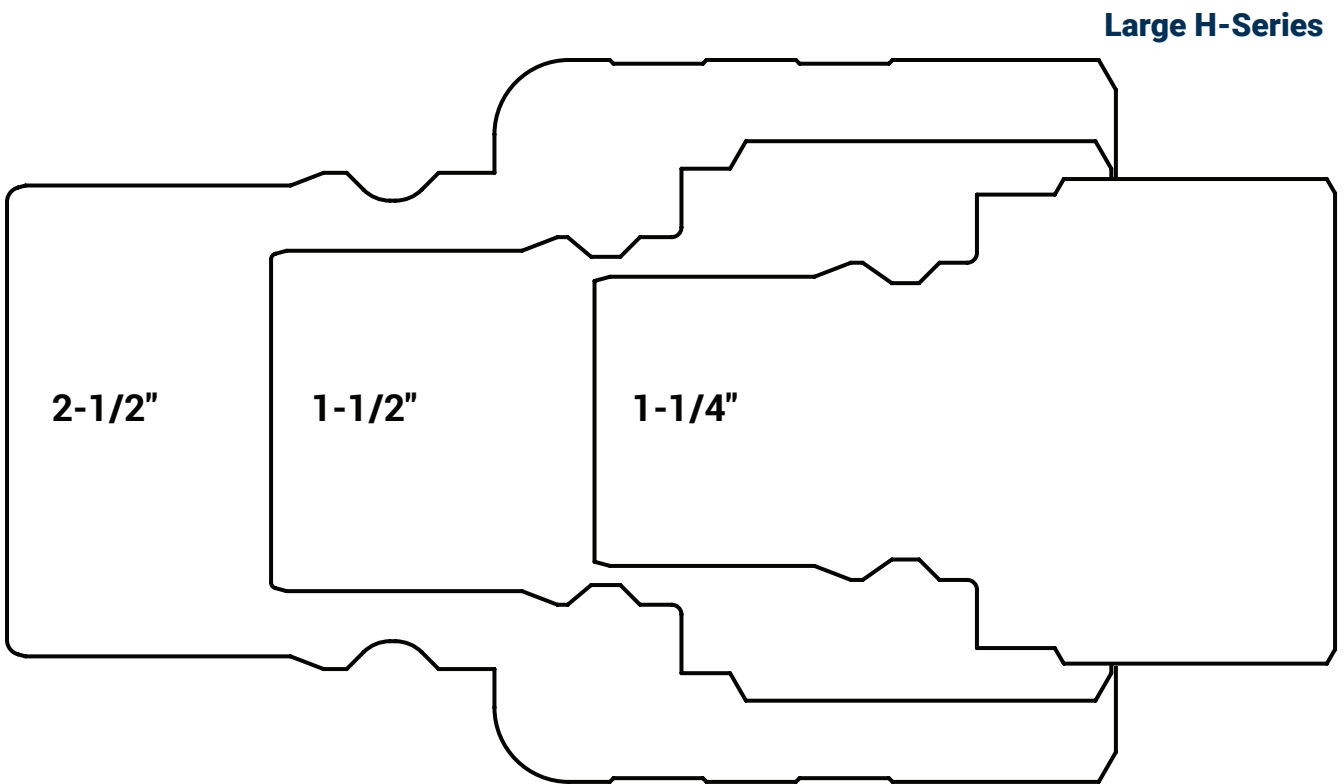

Large H-Series

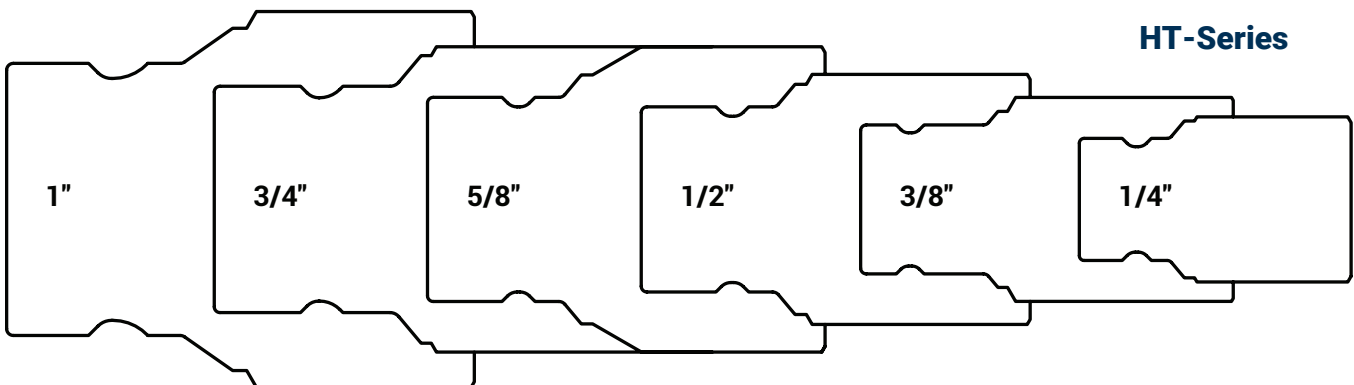

HT-Series

V-Series

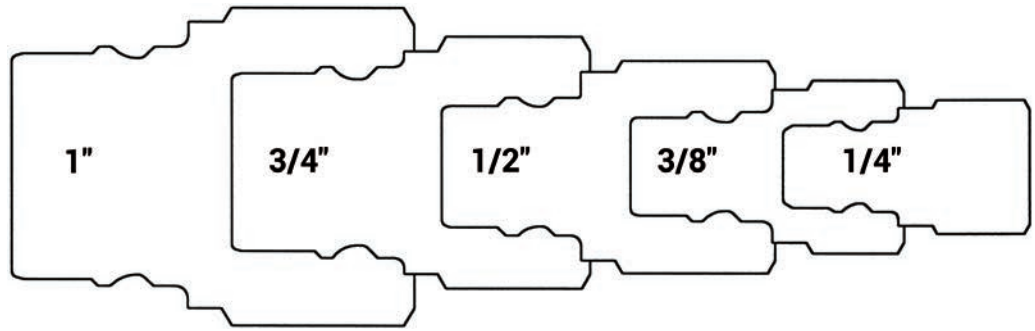

Large V-Series

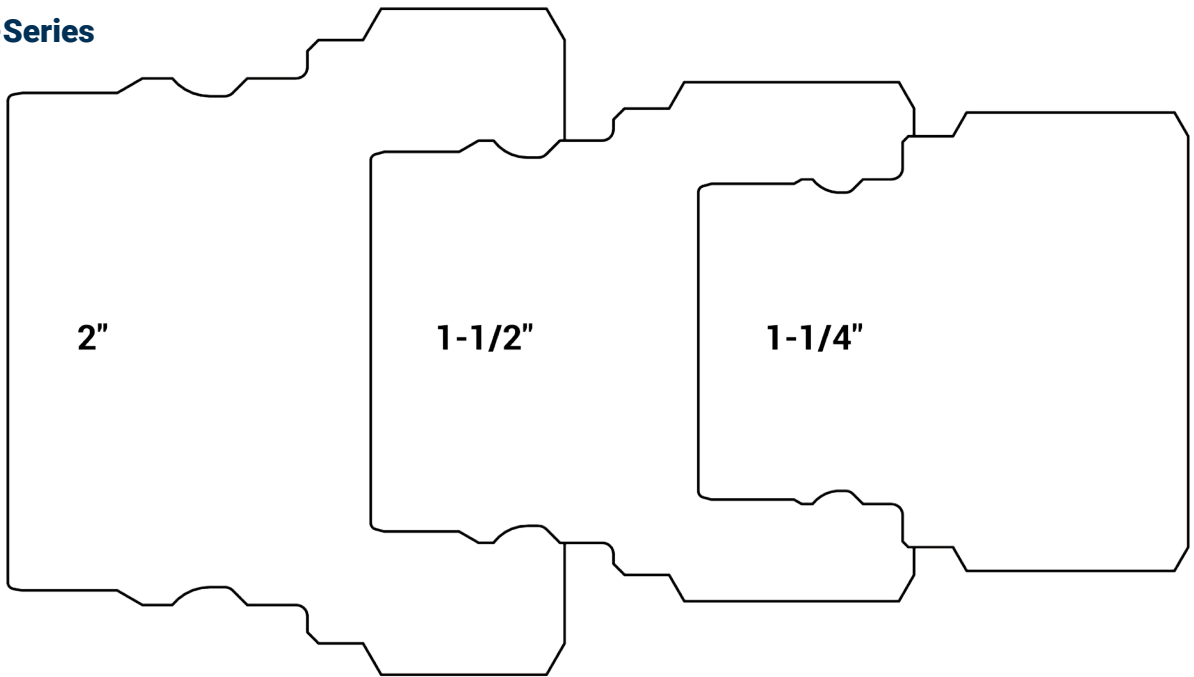

W-Series

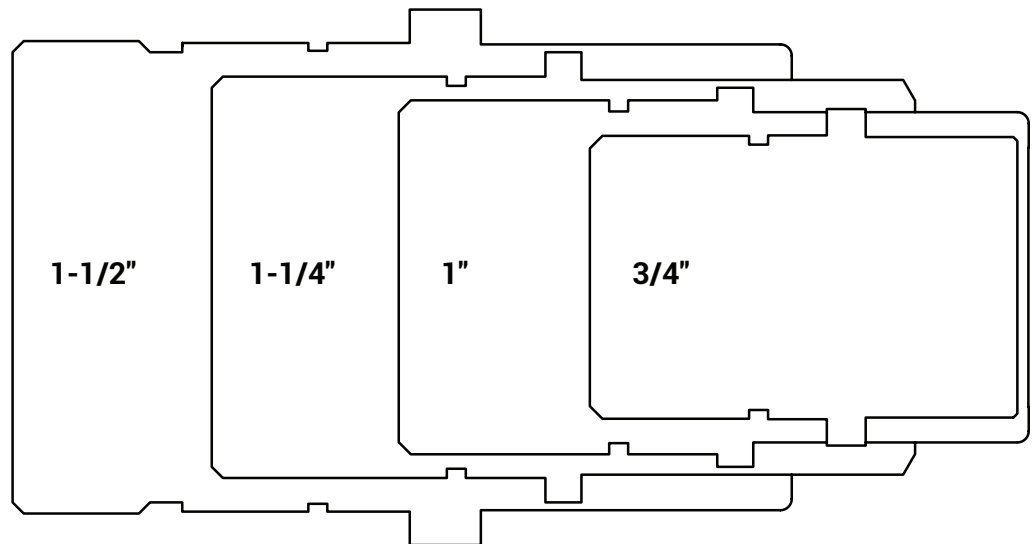

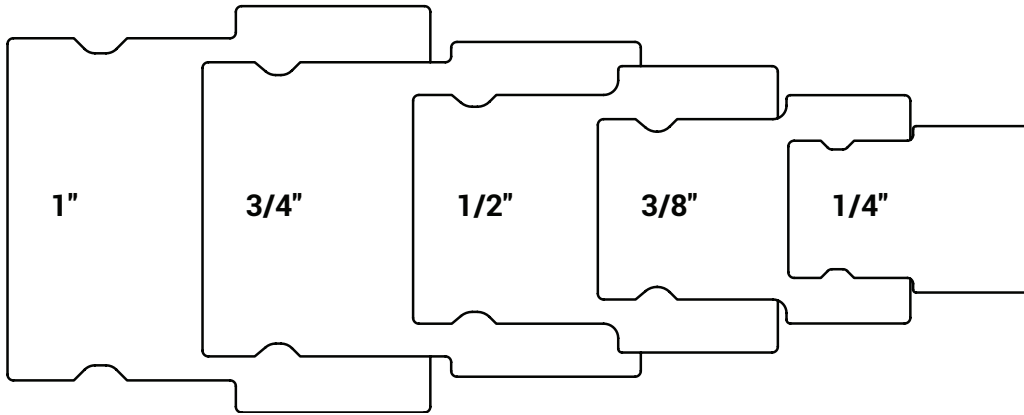

ST-Series

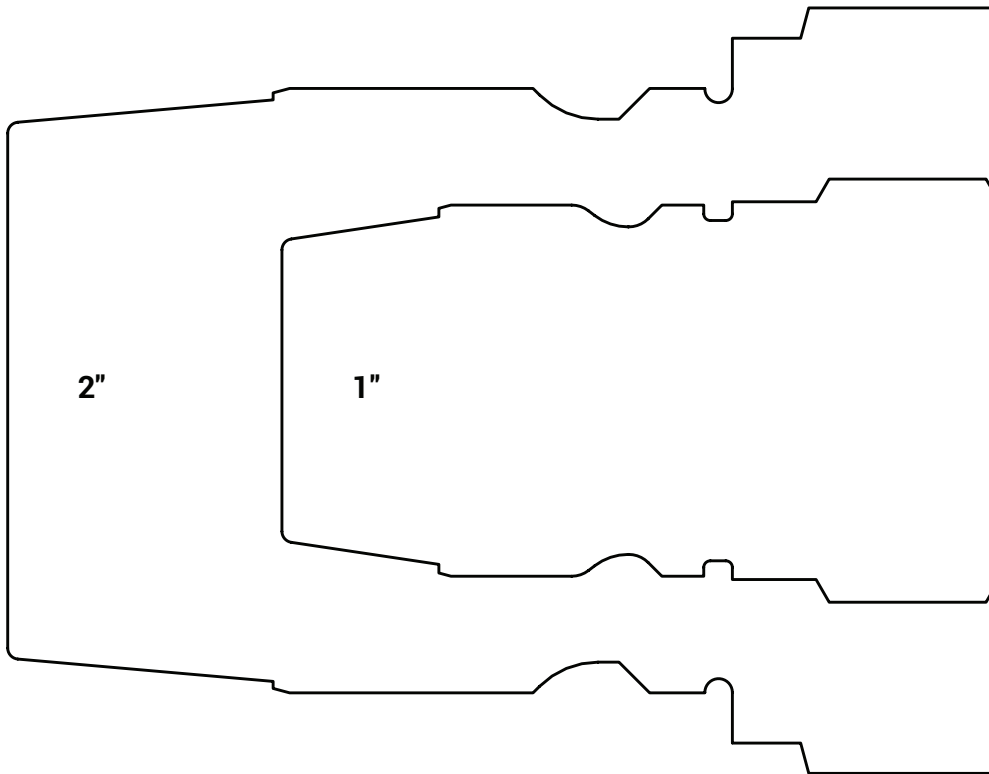

Large ST-Series

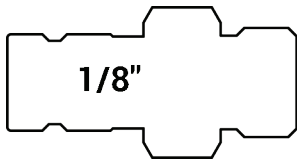

PD-Series

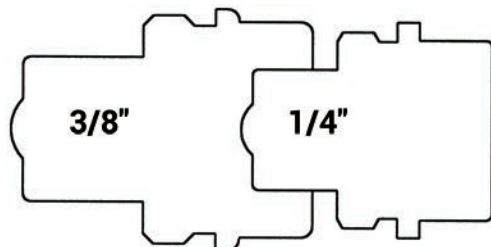

T-Series

E-Series

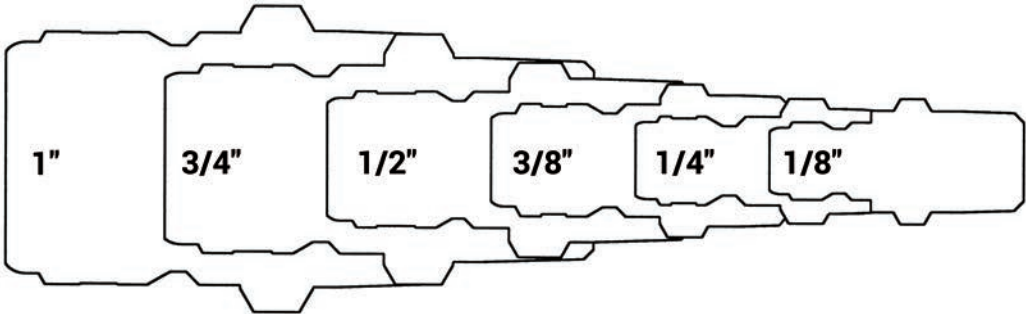

Large E-Series

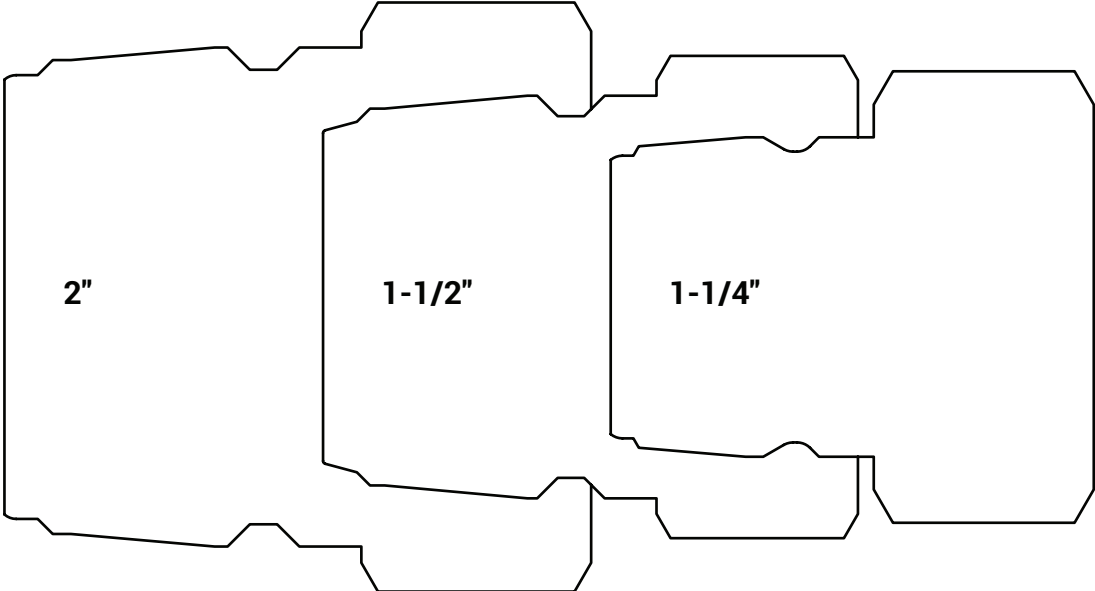

EA-Series

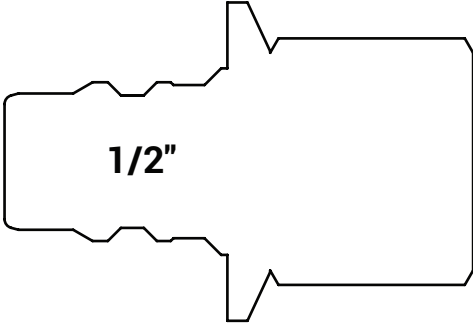

CM-Series

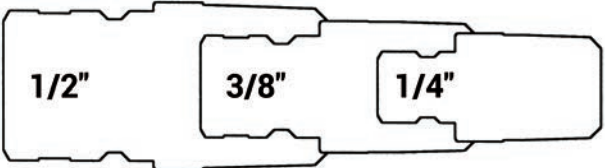

Be Safe When Selecting Quick Couplings

! All quick disconnect couplings should be viewed as potential hazards that can cause property damage, personal injury or even death if used or installed improperly. Improper use includes selecting a product unsuitable for your application, installing or using the product incorrectly, and/or ignoring signs of imminent failure or misuse. Failure may result in explosive propulsion of components, rapid expulsion of hazardous media, and failure or unintentional movement of a fluid-powered component.

Proper Selection of Quick Disconnect Couplings

The very properties that make a compressed media useful in almost every area of modern life can also make it dangerous when mishandled. Dixon quick disconnect couplings have been carefully engineered to meet specific industry requirements while maintaining abundant safety margins. If quick disconnect couplings are not used in the correct applications or are incorrectly applied, accidents and downtime can result. It is up to the end user to inform the distributor of the application and pressures involved when ordering quick disconnect couplings, and it is up to the distributor to supply the right coupling for the application.

The use of S.T.A.M.P.E.D. will help in the proper selection of quick disconnect coupling products. When in doubt, Dixon will provide information, including test results (if available), coupling recommendations, and other data to help resolve quick disconnect coupling related issues.

S.T.A.M.P.E.D. Questions and Selection Process

- Size** Couplings should be selected to handle the flow and pressure requirements of the system. Excessive pressure drop will result in restricted flow, slower actuation, higher fluid velocity, heat generation, and eventually a breakdown of fluids, seals, and components.
1. What size coupler is required?
 2. What is the maximum allowable pressure drop for the application?
 3. Are there any size restrictions due to a 'tight-spot' installation?
- Temperature** Media and ambient temperatures must be limited to the specific operating parameters of the selected sealing materials. Excessive cold will reduce sealing capability, while excessive heat can cause the premature breakdown of body and valve seals.
1. What is the media/fluid temperature?
 2. What is the ambient temperature?
 3. Are there any 'flash' heat or fire sources near the connection?
- Application** Quick coupling interchangeability needs to be closely reviewed. There are several instances where non-interchangeable couplers and plugs may connect. This is very dangerous and these couplings should never be pressurized. Be sure to match like series couplers and plugs.
1. Is an industry interchange coupler required?
 2. What are the functional requirements of the coupling?
 3. Have there been any problems with other couplings in this application?
- Media** Quick disconnect couplings are available with a variety of body materials and seal options. Exposure to harsh and corrosive operating environments may reduce service life. Several quick couplings spill fluid upon disconnection, which may be a safety concern.
1. Which seal and body materials are compatible with the system fluid?
 2. Is air inclusion, system contamination, or fluid loss a concern?
 3. Is this fluid dangerous to the operator?
- Pressure** During the selection process, the published working pressure of the coupling must be equal to or greater than the maximum system pressure. Surge pressures in a fluid power system, higher than the rated pressure, will shorten the service life of the coupling.
1. Is the pressure 'static' or 'dynamic'?
 2. What is the maximum operating pressure required for the application?
 3. Are there any pressure spikes in the system?
- Ends** Many end configurations are available and each one has specific operating parameters. For example, the working pressure of couplings utilizing hose barb or collar hose barb end connections may be dramatically reduced. If in doubt, test under controlled conditions for suitability to the application.
1. What end configuration and size is required? (male threaded, female threaded, or hose barb)
 2. Does the chosen end configuration support the application parameters and system pressure?
 3. What is the ideal valving configuration? (single shut-off, double shut-off, or unvalved)
- Details** Forgotten or missed application details can cause a failure if not properly addressed. Be meticulous in the assessment of your application to ensure that all parameters are considered in the selection of the proper quick disconnect coupling.
1. Are there any side-load, vibration, or swivelling problems associated with the application?
 2. Does the coupling require a safety sleeve-lock mechanism?
 3. Are there any environmental concerns that need to be addressed?

! Quick disconnect couplings can fail without warning. Prior to the operation of quick coupling products, be sure to inspect and replace worn out fittings and safety devices. If a leak is detected during operation, release the pressure from the circuit before investigating the cause of the fluid leak. Do not use your fingers or skin to check for leaks. High-pressure leaks of fluids can easily penetrate the skin and can cause serious injury or death.

Safe Quick Coupling Practices

1. Always wipe the coupling cavities and faces clean before connecting a coupling.
2. Connect coupling before installation to ensure that it works properly.
3. Always check the body seals before connecting a coupling.
4. Shut off power source before connecting a coupling.
5. Always install a safety check valve on a pneumatic line and/or compressor.
6. Always use a safety cable on large air lines (1/2" lines and larger).
7. Always use a whip hose on hydraulic or air tools.
8. Use dust caps or plugs when couplings are not in use.
9. If the locking sleeve is inoperable, check the safety lock.
10. Wear eye protection while connecting or disconnecting a coupling.

Unsafe Quick Coupling Practices

1. Never hit coupling valves to release trapped pressure.
2. Never leave couplings in the path of moving equipment.
3. Never use couplings near a welder, flash heat, or fire/flare sources.
4. Never use API modified sealants or over-apply PTFE tape during installation.
5. Use care if you must install quick couplings onto black iron pipe.
6. Never hit a coupling sleeve with a hammer or blunt object.
7. Never overtighten a coupling connection.
8. Never rotate a quick disconnect coupling under pressure.
9. Do not over-pressurize quick disconnect couplings.
10. Never use a hose with a quick disconnect coupling to lift a tool.

OSHA Regulations Ensure Operator Safety



Safety King Cable®



Safety Check Valves

Standard - 29 CFR, 1926.302 (partial):

(b)(1) Pneumatic power tools shall be secured to the hose or whip by some positive means to prevent the tool from becoming accidentally disconnected.

(b)(2) Safety Clips or retainers shall be securely installed and maintained on pneumatic impact (percussion) tools to prevent attachments from being accidentally expelled.

(b)(4) Compressed air shall not be used for cleaning purposes except where reduced to **30 PSI** and then only with effective chip guarding and personal protective equipment which meets the requirements of Subpart E of this part. The **30 PSI** requirement does not apply for concrete form, mill scale, and similar cleaning purposes.

(b)(5) The manufacturer's safe operating pressure for hoses, pipes, valves, filters and other fittings shall not be exceeded.

(b)(6) The use of hoses for hoisting or lowering tools shall not be permitted.

(b)(7) All hoses exceeding 1/2" inside diameter shall have a safety device at the source of supply or branch line to reduce pressure in case of hose failure.

Standard - 29 CFR, 1926.603 (partial):

(a)(9) Steam hose leading to a steam hammer or jet pipe shall be securely attached to the hammer with an adequate length of at least 1/4" diameter chain or cable to prevent whipping in the event the joint at the hammer is broken. Air hammer hoses shall be provided with the same protection as required for steam lines.

(a)(10) Safety chains, or equivalent means, shall be provided for each hose connection to prevent the line from thrashing around in case the coupling becomes disconnected.

The regulations may be viewed in full on the OSHA website, osha.gov. Please check the website for updates.

Be Safe When Installing Quick Couplings

! All quick disconnect couplings should be viewed as potential hazards that can cause property damage, personal injury, or even death if used or installed improperly.

Couplings should be installed in a location that will allow easy operation of the coupling and accessibility for all necessary installation tools. Care should be given to consider operator safety, especially if spillage upon disconnection could result in fluid ignition or skin and eye irritation.

Only apply wrenches to the hex or machined wrench flats that are provided for assembly purposes, nowhere else. Never clamp on the sleeve of the coupler or the nose of the plug as this will cause distortion and/or damage.

Finally, always test quick coupling installations before putting into operation by pressurizing the unit to 150% of the working pressure in an enclosed/protective environment.

Installation of Tapered Thread Connections (NPTF)

The seal for NPTF threads is created by the metal-to-metal contact between the roots and crests of the male and female threads. Using too much PTFE tape or pairing liquid sealant with PTFE tape may cause distortion, poor thread engagement, or cracking of the coupling during assembly.

The total number of tapered threads engaged should be between 3-1/2 to 6. Any number of threads outside this range may indicate either under-or-over-tightening of the joint or out-of-tolerance threads. After assembly of an NPTF thread connection, always proof-test the connection before operating the system. If the joint proves to be inadequately tightened during proof-pressure testing, tighten it further in 1/8 turn increments until a reliable seal is attained. (Do not exceed 3 turns from finger tight (TFFT))



Apply 1-1/2 to 2 wraps of PTFE tape, starting one or two threads from the lead edge, in a clockwise direction. For 316 stainless steel, be sure to use stainless grade tape.



Check threads to make sure there is no obvious damage on either half and that tape is properly installed. Align male and female threaded connections and carefully begin threading the two halves together.



Finger tighten the connection and create a reference mark on the hex of the hose end/adaptor and the coupling. This mark will help identify the number of revolutions during the next step in the procedure.



With even and smooth force applied, wrench tighten according to the TFFT values listed below. DO NOT OVERTIGHTEN.

SAE Size	NPTF Thread Size	TFFT
-4	1/4" - 18	2
-6	3/8" - 18	2
-8	1/2" - 14	2
-12	3/4" - 14	1.5
-16	1" - 11-1/2	1.5

Be Safe When Installing Quick Couplings

Installation of O-ring Boss (ORB) Connections



Lightly lubricate the O-ring on the adapter and thread it into the coupling. Hand-tighten, ensuring that the O-ring is not pinched during installation.



Wrench tighten the connection to the appropriate torque specification, as shown in the chart below.

SAE Size	Thread Size	Torque (Nm)	Torque (lb-ft)
-4	7/16" - 20	18 - 20	13 - 15
-6	9/16" - 18	29 - 33	22 - 24
-8	3/4" - 16	49 - 53	40 - 43
-10	7/8" - 14	59 - 64	43 - 48
-12	1-1/16" - 12	93 - 102	68 - 75
-16	1-5/16" - 12	151 - 166	112 - 123
-20	1-5/8" - 12	198 - 218	146 - 161
-24	1-7/8" - 12	209 - 231	154 - 170

Installation of 37° Flare (JIC) Connections



Lightly lubricate the flare on the adapter and thread it into the coupling. Hand-tighten, ensuring that the flare is seated correctly during installation.



Wrench tighten the connection to the appropriate torque specification, as shown in the chart below.

SAE Size	Thread Size	Torque (Nm)	Torque (lb-ft)
-4	7/16" - 20	15 - 16	11 - 12
-6	9/16" - 18	24 - 28	18 - 20
-8	3/4" - 16	49 - 53	36 - 39
-10	7/8" - 14	77 - 85	57 - 63
-12	1-1/16" - 12	107 - 119	79 - 88
-16	1-5/16" - 12	147 - 154	108 - 113
-20	1-5/8" - 12	172 - 181	127 - 133
-24	1-7/8" - 12	215 - 226	158 - 167

Be Safe When Installing Quick Couplings

Installation of Reusable Hose Couplings

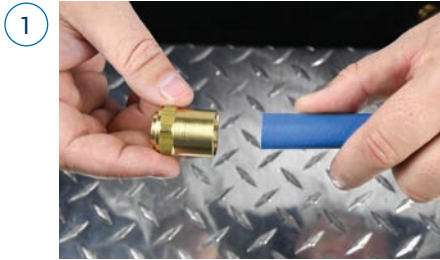

Trim the end of the hose as square as possible.



Install ferrule by slipping it onto the end of the hose and twisting it counter-clockwise.

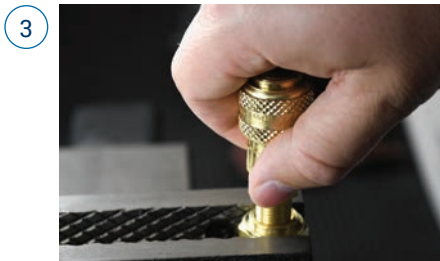

Apply lubricant sparingly to the reusable barbs before inserting it into the ferrule.



Turn the reusable fitting into the ferrule until coupling is seated against ferrule.

Installation of Push-Loc Hose Connections

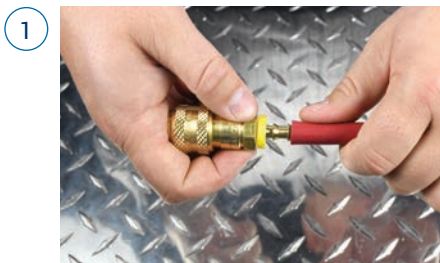

Trim hose end squarely and lubricate the Push-Loc barbs and hose. Insert Push-Loc barbs into the hose until first barbs is inside the hose.



Place the end of the fitting against a flat object and grip the hose one inch from end. Push with a steady force until the end of hose is covered by the yellow plastic cap.

Be Safe When Installing Quick Couplings

Installation of N and P Series Ferruled Hose Barbs

Note that the charts below are to be used only as a guide and not as a steadfast rule for every coupling application. In some instances, alternative dies and crimped dimensions must be employed. Hoses, as well as couplings, react differently during crimping. This is due to the fact that there are variances in hose constructions for hose with similar dimensions. Some variables are: textile braid versus wire braid, hardwall versus softwall, presence or lack of internal spiral wire as well as differences in hose covers. In addition, the outer diameter of the hose tends to fluctuate from end to end and production lot to production lot. With this in mind, we suggest that you measure the hose O.D. and maintain accurate records for each coupling application.

Hose I.D.	Fractional Hose O.D.	Decimal Hose O.D.	'N' Crimp Length	'N' Crimp O.D. ±.005	'P' Crimp Length	'P' Crimp O.D. ±.005
1/2"	54/64"	0.844	1-1/8"	0.917	1-1/4"	0.917
	55/64"	0.859	1-1/8"	0.929	1-1/4"	0.929
	56/64"	0.875	1-1/8"	0.942	1-1/4"	0.942
	57/64"	0.891	1-1/8"	0.954	1-1/4"	0.954
	58/64"	0.906	1-1/8"	0.967	1-1/4"	0.967
	59/64"	0.922	1-1/8"	0.980	1-1/4"	0.980
	60/64"	0.938	1-1/8"	0.992	1-1/4"	0.992
	61/64"	0.953	1-1/8"	1.005	1-1/4"	1.005
	62/64"	0.969	1-1/8"	1.018	1-1/4"	1.018
	63/64"	0.984	1-1/8"	1.030	1-1/4"	1.030
	1"	1.000	1-1/8"	1.043	1-1/4"	1.043
	1-1/64"	1.016	1-1/8"	1.056	1-1/4"	1.056
1-2/64"	1.031	1-1/8"	1.068	1-1/4"	1.068	
3/4"	1-10/64"	1.156	1-1/4"	1.220	1-1/4"	1.220
	1-11/64"	1.171	1-1/4"	1.235	1-1/4"	1.235
	1-12/64"	1.187	1-1/4"	1.244	1-1/4"	1.244
	1-13/64"	1.203	1-1/4"	1.260	1-1/4"	1.260
	1-14/64"	1.218	1-1/4"	1.270	1-1/4"	1.270
	1-15/64"	1.234	1-1/4"	1.285	1-1/4"	1.285
	1-16/64"	1.250	1-1/4"	1.295	1-1/4"	1.295
	1-17/64"	1.265	1-1/4"	1.310	1-1/4"	1.310
	1-18/64"	1.281	1-1/4"	1.320	1-1/4"	1.320
	1-19/64"	1.296	1-1/4"	1.335	1-1/4"	1.335
	1-20/64"	1.312	1-1/4"	1.345	1-1/4"	1.345
	1-21/64"	1.328	1-1/4"	1.360	1-1/4"	1.360
	1-22/64"	1.343	1-1/4"	1.370	1-1/4"	1.370

Installation of Light-Duty Ferrules

Hose I.D.	Fractional Hose O.D.	Decimal Hose O.D.	Dixon Part #	Ferrule Thickness	SMOD	% Compression	Crimp Diameter
1/2"	54/64"	0.8438	CCF0906	0.024	0.513	15	0.853
	55/64"	0.8594	CCF0906	0.024	0.513	15	0.866
	56/64"	0.8750	CCF0906	0.024	0.513	15	0.880
3/4"	1-5/64"	1.0781	CCF1120	0.030	0.763	20	1.086
	1-6/64"	1.0938	CCF1120	0.030	0.763	20	1.098
	1-7/64"	1.1094	CCF1149	0.030	0.763	20	1.111
	1-8/64"	1.1250	CCF1149	0.030	0.763	20	1.123
	1-9/64"	1.1406	CCF1190	0.025	0.763	20	1.126
	1-10/64"	1.1563	CCF1190	0.025	0.763	20	1.138
	1-11/64"	1.1719	CCF1218	0.025	0.763	20	1.151
	1-12/64"	1.1875	CCF1218	0.025	0.763	20	1.163
	1-13/64"	1.2031	CCF1246	0.030	0.763	20	1.186
	1-14/64"	1.2188	CCF1246	0.030	0.763	20	1.198
	1-15/64"	1.2344	CCF1277	0.030	0.763	20	1.211
	1-16/64"	1.2500	CCF1277	0.030	0.763	20	1.223
	1"	1-25/64"	1.3906	CCF1438	0.030	1.007	20
1-26/64"		1.4063	CCF1438	0.030	1.007	20	1.392
1-27/64"		1.4219	CCF1469	0.030	1.007	20	1.405
1-28/64"		1.4375	CCF1469	0.030	1.007	20	1.417
1-29/64"		1.4531	CCF1500	0.030	1.007	20	1.430
1-30/64"		1.4688	CCF1500	0.030	1.007	20	1.442
1-31/64"		1.4844	CCF1531	0.030	1.007	20	1.455
1-32/64"		1.5000	CCF1531	0.030	1.007	20	1.467

Fluid Compatibility Guide

! The following chart is intended only as a guide in selecting various elastomers and metals for use with fluids to be conveyed through Dixon quick disconnect couplings. This list does not guarantee suitability for a particular application. Final selection is dependent upon operating pressure, fluid and ambient temperature, concentration of media, duration of exposure, environmental conditions, and frequency of connection and disconnection.

Material	Prefix Code	Trade Name	Range °F	Range °C
Nitrile-N	Standard	Nitrile	-40°F to 250°F	-40°C to 121°C
Nitrile-N (MIL-H-5606 Fluids)	M-	Nitrile	-65°F to 275°F	-54°C to 135°C
Nitrile-N (Hydrocarbon Fuels)	JF-	Nitrile	-65°F to 160°F	-54°C to 71°C
Fluorocarbon Rubber	F-	FKM	-20°F to 400°F	-29°C to 204°C
Ethyl Propylene Diene Monomer	P-	EPDM	-65°F to 300°F	-54°C to 149°C
Neoprene	E-	Neoprene	-45°F to 300°F	-43°C to 149°C
Silicone	S-	Silicone	-100°F to 350°F	-73°C to 177°C
Fluorosilicone (FVMQ)	FS-	Silastic®	-76°F to 376°F	-60°C to 180°C
Urethane	U-	Urethane	-40°F to 180°F	-40°C to 82°C
Polyurethane	UP-	Polyurethane	-65°F to 212°F	-54°C to 100°C
PTFE Encapsulated Silicone	TS-	TES	-100°F to 400°F	-73°C to 204°C
PTFE Encapsulated Fluorocarbon	TF-	TEF	-100°F to 400°F	-73°C to 204°C
Perfluoroelastomer (Compound 1)	K4-	Kalrez® 4079	-4°F to 600°F	-20°C to 316°C
Perfluoroelastomer (Compound 2)	K6-	Kalrez® 6375	-4°F to 525°F	-20°C to 275°C
Perfluoroelastomer (Compound 3)	K7-	Kalrez® 7075	-4°F to 620°F	-20°C to 327°C
Fluoroelastomer	H-	Aflas®	23°F to 400°F	-5°C to 204°C

Media Name	Suggested Seal	Media Name	Suggested Seal	Media Name	Suggested Seal
Acetic Anhydride	P-	Freon, General	E-	Mineral Spirits	Standard
Acetone	P-	Ferric Hydroxide	Standard	Nickel Acetate	P-
Acetylene	Standard	Formaldehyde (50%)	P-	Nickel Sulphate	P-
Air (To 200°F)	Standard	Fuel Oils, General	Standard	Nitrogen, Gas	Standard
Air (Above 200°F)	F-	Gasoline	Standard	Nitrous Oxide	Standard
Alcohol, Ethyl	P-	Glycerine (Glycerol)	Standard	Octane	F-
Alcohol, Methyl	Standard	Glycols	P-	Oleum Spirits	Standard
Alkalis, General	Standard	Helium	Standard	OS45 and OS45-1	F-
Ammonia, Aqueous	P-	Heptane	Standard	Oxygen, Non-Breathing	F-
Ammonia, Gas	P-	Hexane	Standard	Paint Thinner	F-
Ammonia, Anhydrous	P-	Hydraulic Oil, Aircraft	Standard	Paraffin	Standard
Ammonia, Hydroxide	P-	Hydraulic Oil, Petroleum	Standard	Peanut Oil	Standard
Aroclor	F-	Hydraulic Oil, Phosphate	P-	Pentane	Standard
Benzene (Benzol)	F-	Hydrogen Gas	Standard	Perchloroethylene	F-
Bleach Solutions	P-	Hydrolube	Standard	Phosphoric Acid (100%)	P-
Brake Fluid, Non-Petro	P-	Isobutyl Alcohol	P-	Photographic Solutions	P-
Bromine Gas	F-	Isopropyl Alcohol	F-	Potassium Acetate	P-
Butyl Alcohol	Standard	Jet Fuel (to 160°F)	JF-	Propylene	F-
Carbon Dioxide, Dry	Standard	Jet Fuel (above 160°F)	F-	Propylene Glycol	Standard
Carbon Dioxide, Wet	Standard	Kerosene	Standard	Silicone Oil	Nitrile
Carbon Monoxide	Standard	Lindol	P-	Steam, General Service	H-
Carbon Tetrachloride	F-	Magnesium Hydroxide	F-	Stoddard Solvent	Standard
Cellulube	P-	Methane	Standard	Sulphuric Acid (100%)	F-
Creosote	F-	Methanol	Standard	Toluene	F-
Crude Oil	F-	Methyl Bromide	F-	Transmission Fluid (A)	Standard
Cutting Oil	Standard	Methyl Ethyl Ketone (MEK)	P-	Trichloroethylene	F-
Diesel Fuel	Standard	MIL-F-81912 (JP-9)	P-	Turpentine	Standard
Diester Lubricants	F-	MIL-H-5606	M1-	Vegetable Oil	Standard
Ethane	Standard	MIL-H-5806	Standard	Water	Standard
Ethanol	P-	MIL-H-6083	Standard	Water, Distilled	Standard
Ethyl Chloride	Standard	MIL-H-7083	Standard	Water, Dionized	Standard
Ethylene Glycol	P-	Mineral Oils	Standard	Water, Sea	P-

Pneumatic Couplings: DF-Series

Interchange Data

- Parker 20-series manual interchange (F-series)
- Parker 30-series automatic interchange (D-series)
- Foster 3, 4, 5, and 6 series
- Hansen 1000, 400, 500 (F-series)
- Hansen 3000, 4000, 5000, 6000 (D-series)

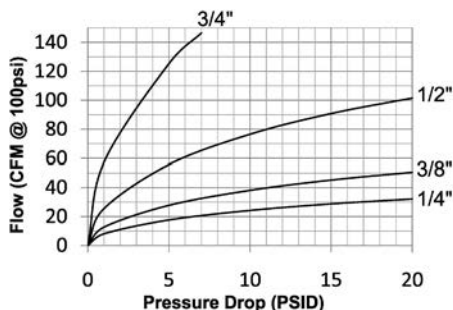

Materials

- Machined components are manufactured using solid steel, brass, or 303 stainless steel bar stock
- Stainless steel balls, retaining rings, and springs maximize corrosion resistance and extend service life
- Steel componentry is plated using ROHS-compliant trivalent chrome
- Automatic couplers constructed of brass with steel tubular valve as standard (3/8" to 3/4" couplers have steel prong valves)
- 1/4" manual couplers constructed of brass with steel sleeve and steel tubular valve as standard
- 3/8" and 1/2" manual couplers constructed of steel as standard with steel tubular valve

Seal Components

- Nitrile seals are standard, providing a temperature range of -40°F to 250°F (-40°C to 121°C)

Rated Pressure Charts

Body Size	D-Series Automatic Industrial Interchange (Connected)															
	Brass Coupler/Steel Plug				Brass Coupler/Plug				Steel Coupler/Plug				303 Stainless Coupler/Plug			
	Max. Working		Burst		Max. Working		Burst		Max. Working		Burst		Max. Working		Burst	
	PSI	Bar	PSI	Bar	PSI	Bar	PSI	Bar	PSI	Bar	PSI	Bar	PSI	Bar	PSI	Bar
1/4"	500	35	16,000	1,100	300	20	16,000	1,100	-	-	-	-	500	35	26,000	1,795
3/8"	500	35	15,500	1,070	300	20	14,500	1,000	-	-	-	-	500	35	25,500	1,760
1/2"	500	35	14,000	965	300	20	10,500	725	-	-	-	-	500	35	20,500	1,415
3/4"	500	35	10,000	670	-	-	-	-	-	-	-	-	-	-	-	-

Body Size	F-Series Manual Industrial Interchange (Connected)															
	Brass Coupler/Steel Plug				Brass Coupler/Plug				Steel Coupler/Plug				303 Stainless Coupler/Plug			
	Max. Working		Burst		Max. Working		Burst		Max. Working		Burst		Max. Working		Burst	
	PSI	Bar	PSI	Bar	PSI	Bar	PSI	Bar	PSI	Bar	PSI	Bar	PSI	Bar	PSI	Bar
1/4"	500	35	9,000	620	300	20	8,500	586	500	35	6,500	448	500	35	11,500	795
3/8"	500	35	11,500	790	300	20	10,000	690	500	35	19,500	1,345	500	35	20,500	1,415
1/2"	-	-	-	-	-	-	-	-	500	35	15,500	1,070	500	35	15,000	1,035

Technical Specifications

Body Size	Interchange Standards				Functional Parameters				
	U.S. Military	U.S. Government	International Standards	ANSI/NFPA Standards	Locking Ball Quantity	Air Inclusion	Fluid Loss	Vacuum Rating	Flow ΔP=15 PSI
1/4"	MIL-C-4109F	A-A-59439	ISO6150B	T3.20.14-1990	6	N/A	N/A	N/R	27 CFM
3/8"	-	-	ISO6150B	T3.20.14-1990	6	N/A	N/A	N/R	45 CFM
1/2"	MIL-C-4109F	A-A-59439	ISO6150B	T3.20.14-1990	6	N/A	N/A	N/R	91 CFM
3/4"	-	-	-	T3.20.14-1990	9	N/A	N/A	N/R	200 CFM

Available Options

Body Size	Seal Options		Valve Options			Sleeve Options				Treatments
	FKM	EPDM	Unvalved	Brass	303 SS	Flanged	Sleeve-Lock	Brass	303 SS	Oxy-Clean
	Pre	Pre	Suf	Suf	Suf	Suf	Suf	Suf	Suf	Suf
1/4"	F-	P-	-E	-BV	-SV	N/A	-LS	-BS	-XS	-C1
3/8"	F-	N/A	-E	-BV	-SV	N/A	-LS	N/A	-XS	-C1
1/2"	F-	N/A	-E	-BV	-SV	N/A	-LS	N/A	-XS	-C1
3/4"	N/A-	N/A	-E	N/A	N/A	N/A	-LS	-BS	N/A	-C1

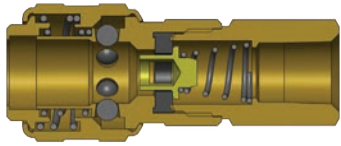

Body Size	D-Series Automatic Industrial Interchange Coupler (Female Threads)							
	Part Detail			Length		Maximum O.D.		Hex Inch
	Part #	Threads	Material	inch	mm	inch	mm	
1/4"	2DF1-B	1/8" - 27 NPTF	brass	2.19	55.6	0.99	25.1	11/16"
	2DF2-B	1/4" - 18 NPTF	brass	2.38	60.5	0.99	25.1	11/16"
	2DF2-S	1/4" - 18 NPTF	303 stainless	2.38	60.5	0.99	25.1	11/16"
	2DBF2-B	1/4" - 19 BSPP	brass	2.38	60.5	0.99	25.1	11/16"
	2DF3-B	3/8" - 18 NPTF	brass	2.38	60.5	0.99	25.1	11/16"
	2DF3-S	3/8" - 18 NPTF	303 stainless	2.38	60.5	0.99	25.1	13/16"
3/8"	2DBF3-B	3/8" - 19 BSPP	brass	2.38	60.5	0.99	25.1	13/16"
	3DF2-B	1/4" - 18 NPTF	brass	2.50	63.5	1.26	32.0	7/8"
	3DF3-B	3/8" - 18 NPTF	brass	2.60	66.0	1.26	32.0	7/8"
	3DF3-S	3/8" - 18 NPTF	303 stainless	2.60	66.0	1.26	32.0	7/8"
	3DBF3-B	3/8" - 19 BSPP	brass	2.60	66.0	1.26	32.0	7/8"
1/2"	3DF4-B	1/2" - 14 NPTF	brass	2.80	71.1	1.26	32.0	1"
	4DF3-B	3/8" - 18 NPTF	brass	3.10	78.7	1.38	35.1	1-1/16"
	4DF4-B	1/2" - 14 NPTF	brass	3.30	83.8	1.38	35.1	1-1/16"
	4DF4-S	1/2" - 14 NPTF	303 stainless	3.30	83.8	1.38	35.1	1-1/16"
	4DBF4-B	1/2" - 14 BSPP	brass	3.30	83.8	1.38	35.1	1-1/16"
	4DF6-B	3/4" - 14 NPTF	brass	3.40	86.4	1.38	35.1	1-3/16"
3/4"	6DF4-B	1/2" - 14 NPTF	brass	2.95	74.9	1.73	43.9	1-5/16"
	6DF6-B	3/4" - 14 NPTF	brass	2.99	75.9	1.73	43.9	1-5/16"
	6DF8-B	1" - 11-1/2 NPTF	brass	3.18	80.8	1.73	43.9	1-1/2"

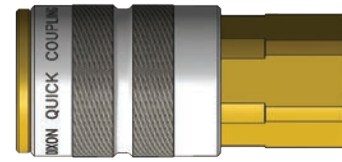
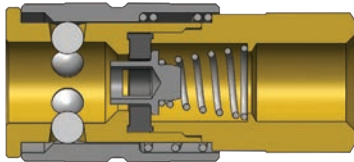

Body Size	F-Series Manual Industrial Interchange Coupler (Female Threads)							
	Part Detail			Length		Maximum O.D.		Hex Inch
	Part #	Threads	Material	Inch	mm	Inch	mm	
1/4"	2FF1-B	1/8" - 27 NPTF	brass	1.91	48.6	0.93	23.5	3/4"
	2FBF1-B	1/8" - 28 BSPP	brass	1.91	48.6	0.93	23.5	3/4"
	2FF2	1/4" - 18 NPTF	steel	2.07	52.6	0.93	23.5	3/4"
	2FF2-B	1/4" - 18 NPTF	brass	2.07	52.6	0.93	23.5	3/4"
	2FF2-S	1/4" - 18 NPTF	303 stainless	2.07	52.6	0.93	23.5	3/4"
	2FBF2-B	1/4" - 19 BSPP	brass	2.07	52.6	0.93	23.5	3/4"
	2FF3-B	3/8" - 18 NPTF	brass	2.10	53.4	0.93	23.5	13/16"
	2FF3-S	3/8" - 18 NPTF	303 stainless	2.10	53.4	0.93	23.5	13/16"
3/8"	2FBF3-B	3/8" - 19 BSPP	brass	2.13	54.2	0.93	23.5	13/16"
	3FF2	1/4" - 18 NPTF	steel	2.41	61.2	1.13	28.6	7/8"
	3FF3	3/8" - 18 NPTF	steel	2.41	61.2	1.13	28.6	7/8"
	3FF3-S	3/8" - 18 NPTF	303 stainless	2.41	61.2	1.13	28.6	7/8"
	3FBF3	3/8" - 19 BSPP	steel	2.42	61.5	1.13	28.6	7/8"
1/2"	3FF4	1/2" - 14 NPTF	steel	2.63	66.9	1.13	28.6	1"
	4FF3	3/8" - 18 NPTF	steel	2.85	72.5	1.24	31.4	1"
	4FF4	1/2" - 14 NPTF	steel	3.06	77.8	1.24	31.4	1"
	4FF4-S	1/2" - 14 NPTF	303 stainless	3.06	77.8	1.24	31.4	1"
	4FBF4	1/2" - 14 BSPP	steel	3.09	78.4	1.24	31.4	1"
	4FF6	3/4" - 14 NPTF	steel	3.15	79.9	1.24	31.4	1-3/16"

Pneumatic Couplings: DF-Series

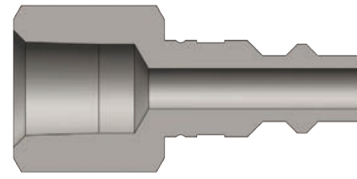

Body Size	DF-Series Industrial Interchange Plug (Female Threads)							
	Part Detail			Length		Maximum O.D.		Hex Inch
	Part #	Threads	Material	inch	mm	inch	mm	
1/4"	D2F1	1/8" - 27 NPTF	steel	1.44	36.6	0.65	16.5	9/16"
	D2F2	1/4" - 18 NPTF	steel	1.66	42.2	0.79	20.1	11/16"
	D2F2-B	1/4" - 18 NPTF	brass	1.66	42.2	0.79	20.1	11/16"
	D2F2-S	1/4" - 18 NPTF	303 stainless	1.66	42.2	0.79	20.1	11/16"
	D2BF2	1/4" - 19 BSPP	steel	1.66	42.2	0.79	20.1	11/16"
	D2F3	3/8" - 18 NPTF	steel	1.66	42.2	1.01	25.7	7/8"
	D2F3-B	3/8" - 18 NPTF	brass	1.66	42.2	1.01	25.7	7/8"
	D2F3-S	3/8" - 18 NPTF	303 stainless	1.66	42.2	1.01	25.7	7/8"
3/8"	D3F2	1/4" - 18 NPTF	steel	1.78	45.2	0.79	20.1	11/16"
	D3F3	3/8" - 18 NPTF	steel	1.78	45.2	1.01	25.7	7/8"
	D3F3-B	3/8" - 18 NPTF	brass	1.78	45.2	1.01	25.7	7/8"
	D3F3-S	3/8" - 18 NPTF	303 stainless	1.78	45.2	1.01	25.7	7/8"
	D3BF3	3/8" - 19 BSPP	steel	1.78	45.2	1.01	25.7	7/8"
	D3F4	1/2" - 14 NPTF	steel	1.94	49.3	1.16	29.5	1"
1/2"	D4F3	3/8" - 18 NPTF	steel	2.10	53.3	1.01	25.7	7/8"
	D4F4	1/2" - 14 NPTF	steel	2.27	57.7	1.16	29.5	1"
	D4F4-B	1/2" - 14 NPTF	brass	2.27	57.7	1.16	29.5	1"
	D4F4-S	1/2" - 14 NPTF	303 stainless	2.27	57.7	1.16	29.5	1"
	D4BF4	1/2" - 14 BSPP	steel	2.27	57.7	1.16	29.5	1"
	D4F6	3/4" - 14 NPTF	steel	2.30	58.4	1.37	34.8	1-3/16"
	D4F6-B	3/4" - 14 NPTF	brass	2.30	58.4	1.37	34.8	1-3/16"
3/4"	D6F4	1/2" - 14 NPTF	steel	2.22	56.4	1.52	38.6	1-5/16"
	D6F6	3/4" - 14 NPTF	steel	2.22	56.4	1.52	38.6	1-5/16"
	D6F8	1" - 11-1/2 NPTF	steel	2.41	61.2	1.80	45.7	1-9/16"

DF Series Pneumatic Profile

Body Size	A	B
1/4"	0.32	0.21
3/8"	0.43	0.30
1/2"	0.56	0.38
3/4"	0.80	0.28

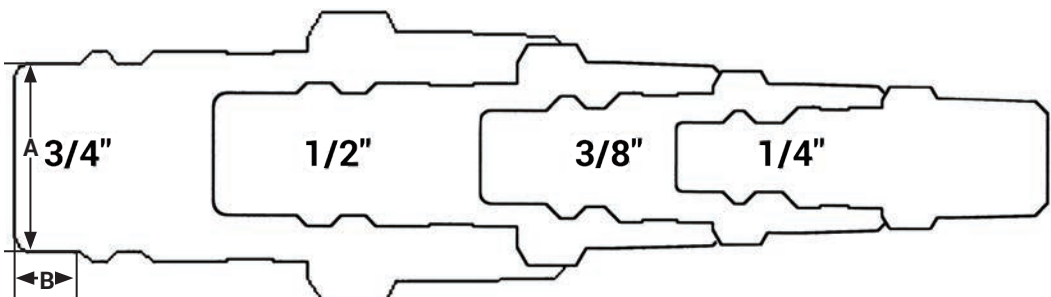

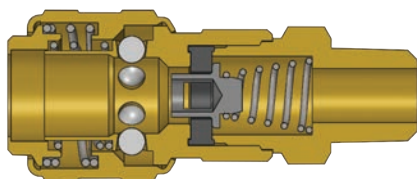

Body Size	D-Series Automatic Industrial Interchange Coupler (Male Threads)							
	Part Detail			Length		Maximum O.D.		Hex Inch
	Part #	Threads	Material	inch	mm	inch	mm	
1/4"	2DM1-B	1/8" - 27 NPTF	brass	2.21	56.1	0.98	24.9	11/16"
	2DM2-B	1/4" - 18 NPTF	brass	2.34	59.4	0.98	24.9	11/16"
	2DM2-S	1/4" - 18 NPTF	303 stainless	2.34	59.4	0.98	24.9	11/16"
	2DBM2-B	1/4" - 19 BSPT	brass	2.34	59.4	0.98	24.9	11/16"
	2DM3-B	3/8" - 18 NPTF	brass	2.36	59.9	0.98	24.9	11/16"
	2DM3-S	3/8" - 18 NPTF	303 stainless	2.36	59.9	0.98	24.9	11/16"
	2DBM3-B	3/8" - 19 BSPT	brass	2.36	59.9	0.98	24.9	11/16"
3/8"	3DM2-B	1/4" - 18 NPTF	brass	2.59	65.8	1.18	30.0	7/8"
	3DM3-B	3/8" - 18 NPTF	brass	2.73	69.3	1.18	30.0	7/8"
	3DM3-S	3/8" - 18 NPTF	303 stainless	2.73	69.3	1.18	30.0	7/8"
	3DBM3-B	3/8" - 19 BSPT	brass	2.73	69.3	1.18	30.0	7/8"
	3DM4-B	1/2" - 14 NPTF	brass	2.94	74.7	1.18	30.0	7/8"
1/2"	4DM3-B	3/8" - 18 NPTF	brass	3.13	79.5	1.34	34.0	1-1/16"
	4DM4-B	1/2" - 14 NPTF	brass	3.17	80.5	1.34	34.0	1-1/16"
	4DM4-S	1/2" - 14 NPTF	303 stainless	3.17	80.5	1.34	34.0	1-1/16"
	4DBM4-B	1/2" - 14 BSPT	brass	3.17	80.5	1.34	34.0	1-1/16"
	4DM6-B	3/4" - 14 NPTF	brass	3.23	82.0	1.34	34.0	1-1/16"
3/4"	6DM4-B	1/2" - 14 NPTF	brass	2.95	74.9	1.90	48.3	1-3/16"
	6DM6-B	3/4" - 14 NPTF	brass	2.95	74.9	1.90	48.3	1-5/16"
	6DM8-B	1" - 11-1/2 NPTF	brass	3.12	79.2	1.90	48.3	1-9/16"

! It is important to be safe when installing quick disconnect couplings into a pneumatic circuit. Never install a pneumatic coupling directly into an air tool. Use a piece of hose that is at least 18" long between the tool and the coupling to prevent damage to the coupling. To protect the operator, safety devices such as a safety check valve and safety cable should be installed in case there is a hose or coupling failure.

Pneumatic Couplings: DF-Series

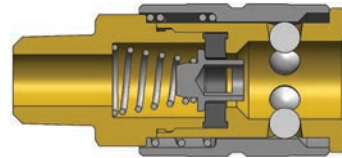
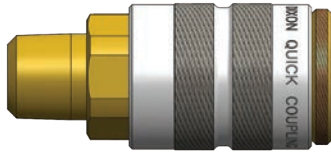

Body Size	F-Series Manual Industrial Interchange Coupler (Male Threads)							
	Part Detail			Length		Maximum O.D.		Hex Inch
	Part #	Threads	Material	inch	mm	inch	mm	
1/4"	2FM1-B	1/8" - 27 NPTF	brass	1.97	50.0	0.88	22.4	3/4"
	2FM1-S	1/8" - 27 NPTF	303 stainless	1.97	50.0	0.88	22.4	3/4"
	2FBM1-B	1/8" - 28 BSPT	brass	1.97	50.0	0.88	22.4	3/4"
	2FM2	1/4" - 18 NPTF	steel	2.04	51.8	0.88	22.4	3/4"
	2FM2-B	1/4" - 18 NPTF	brass	2.04	51.8	0.88	22.4	3/4"
	2FM2-S	1/4" - 18 NPTF	303 stainless	2.04	51.8	0.88	22.4	3/4"
	2FBM2-B	1/4" - 19 BSPT	brass	2.04	51.8	0.88	22.4	3/4"
	2FM3-B	3/8" - 18 NPTF	brass	2.08	52.8	0.88	22.4	3/4"
	2FM3-S	3/8" - 18 NPTF	303 stainless	2.08	52.8	0.88	22.4	3/4"
	2FBM3-B	3/8" - 19 BSPT	brass	2.08	52.8	0.88	22.4	3/4"
3/8"	3FM2	1/4" - 18 NPTF	steel	2.45	62.2	1.06	26.9	7/8"
	3FM3	3/8" - 18 NPTF	steel	2.46	62.5	1.06	26.9	7/8"
	3FM3-S	3/8" - 18 NPTF	303 stainless	2.46	62.5	1.06	26.9	7/8"
	3FBM3	3/8" - 19 BSPT	steel	2.46	62.5	1.06	26.9	7/8"
	3FM4	1/2" - 14 NPTF	steel	2.55	64.8	1.06	26.9	7/8"
1/2"	4FM3	3/8" - 18 NPTF	steel	2.97	75.4	1.19	30.2	1"
	4FM4	1/2" - 14 NPTF	steel	3.07	78.0	1.19	30.2	1"
	4FM4-S	1/2" - 14 NPTF	303 stainless	3.07	78.0	1.19	30.2	1"
	4FBM4	1/2" - 14 BSPT	steel	3.07	78.0	1.19	30.2	1"
	4FM6	3/4" - 14 NPTF	steel	3.12	79.2	1.19	30.2	1-1/16"

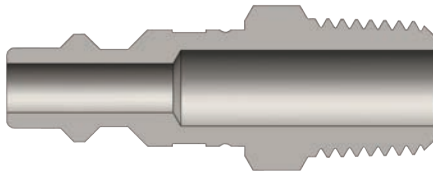

Body Size	DF-Series Industrial Interchange Plug (Male Threads)							
	Part Detail			Length		Maximum O.D.		Hex Inch
	Part #	Threads	Material	inch	mm	inch	mm	
1/4"	D2M1	1/8" - 27 NPTF	steel	1.57	39.9	0.58	14.7	1/2"
	D2M1-B	1/8" - 27 NPTF	brass	1.57	39.9	0.58	14.7	1/2"
	D2M1-S	1/8" - 27 NPTF	303 stainless	1.57	39.9	0.58	14.7	1/2"
	D2M2	1/4" - 18 NPTF	steel	1.69	42.9	0.65	16.5	9/16"
	D2M2-B	1/4" - 18 NPTF	brass	1.69	42.9	0.65	16.5	9/16"
	D2M2-S	1/4" - 18 NPTF	303 stainless	1.69	42.9	0.65	16.5	9/16"
	D2BM2	1/4" - 19 BSPT	steel	1.69	42.9	0.65	16.5	9/16"
	D2M3	3/8" - 18 NPTF	steel	1.75	44.5	0.87	22.1	3/4"
	D2M3-B	3/8" - 18 NPTF	brass	1.75	44.5	0.87	22.1	3/4"
	D2M3-S	3/8" - 18 NPTF	303 stainless	1.75	44.5	0.87	22.1	3/4"
3/8"	D3M2	1/4" - 18 NPTF	steel	1.81	46.0	0.79	20.1	11/16"
	D3M3	3/8" - 18 NPTF	steel	1.87	47.5	0.87	22.1	3/4"
	D3M3-B	3/8" - 18 NPTF	brass	1.87	47.5	0.87	22.1	3/4"
	D3M3-S	3/8" - 18 NPTF	303 stainless	1.87	47.5	0.87	22.1	3/4"
	D3BM3	3/8" - 19 BSPT	steel	1.87	47.5	0.87	22.1	11/16"
	D3M4	1/2" - 14 NPTF	steel	2.03	51.6	1.01	25.7	7/8"
1/2"	D4M2	1/4" - 18 NPTF	steel	2.13	54.1	0.75	19.1	11/16"
	D4M3	3/8" - 18 NPTF	steel	2.19	55.6	0.87	22.1	3/4"
	D4M4	1/2" - 14 NPTF	steel	2.34	59.4	1.01	25.7	7/8"
	D4M4-B	1/2" - 14 NPTF	brass	2.34	59.4	1.01	25.7	7/8"
	D4M4-S	1/2" - 14 NPTF	303 stainless	2.34	59.4	1.01	25.7	7/8"
	D4BM4	1/2" - 14 BSPT	steel	2.34	59.4	1.01	25.7	7/8"
	D4M6	3/4" - 14 NPTF	steel	2.50	63.5	1.23	31.2	1-1/16"
3/4"	D6M4	1/2" - 14 NPTF	steel	2.22	60.5	1.52	38.6	1"
	D6M6	3/4" - 14 NPTF	steel	2.38	60.5	1.52	38.6	1-5/16"
	D6M8	1" - 11-1/2 NPTF	steel	2.56	65.0	1.80	45.7	1-9/16"

Pneumatic Couplings: DF-Series

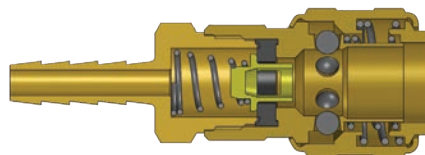

Body Size	D-Series Automatic Industrial Interchange Coupler (Standard Hose Barb)							
	Part Detail			Length		Maximum O.D.		Hex Inch
	Part #	Hose I.D.	Material	inch	mm	inch	mm	
1/4"	2DS2-B	1/4"	brass	2.90	73.7	0.98	24.9	11/16"
	2DS2-S	1/4"	303 stainless	2.90	73.7	0.98	24.9	11/16"
	2DS3-B	3/8"	brass	2.90	73.7	0.98	24.9	11/16"
	2DS3-S	3/8"	303 stainless	2.90	73.7	0.98	24.9	11/16"
3/8"	3DS2-B	1/4"	brass	3.00	76.2	1.18	30.0	7/8"
	3DS3-B	3/8"	brass	3.00	76.2	1.18	30.0	7/8"
	3DS3-S	3/8"	303 stainless	3.00	76.2	1.18	30.0	7/8"
	3DS4-B	1/2"	brass	3.00	76.2	1.18	30.0	7/8"
1/2"	4DS3-B	3/8"	brass	3.51	89.2	1.34	34.0	1-1/16"
	4DS4-B	1/2"	brass	3.51	89.2	1.34	34.0	1-1/16"
	4DS4-S	1/2"	303 stainless	3.51	89.2	1.34	34.0	1-1/16"
	4DS6-B	3/4"	brass	3.51	89.2	1.34	34.0	1-1/16"
3/4"	6DS4-B	1/2"	brass	3.00	76.2	1.73	43.9	1-5/16"
	6DS6-B	3/4"	brass	3.00	76.2	1.73	43.9	1-5/16"
	6DS8-B	1"	brass	3.24	82.3	1.73	43.9	1-5/16"

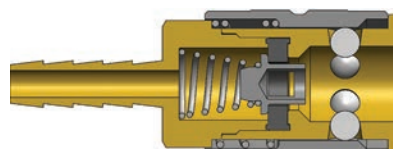
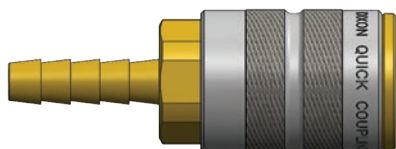

Body Size	F-Series Manual Industrial Interchange Coupler (Standard Hose Barb)							
	Part Detail			Length		Maximum O.D.		Hex Inch
	Part #	Hose I.D.	Material	inch	mm	inch	mm	
1/4"	2FS2	1/4"	steel	2.53	64.3	0.88	22.4	3/4"
	2FS2-B	1/4"	brass	2.53	64.3	0.88	22.4	3/4"
	2FS2-S	1/4"	303 stainless	2.53	64.3	0.88	22.4	3/4"
	2FS2.5-B	5/16"	brass	2.53	64.3	0.88	22.4	3/4"
	2FS3-B	3/8"	brass	2.53	64.3	0.88	22.4	3/4"
	2FS3-S	3/8"	303 stainless	2.53	64.3	0.88	22.4	3/4"
3/8"	3FS2	1/4"	steel	2.86	72.6	1.06	26.9	7/8"
	3FS3	3/8"	steel	2.86	72.6	1.06	26.9	7/8"
	3FS3-S	3/8"	303 stainless	2.86	72.6	1.06	26.9	7/8"
	3FS4	1/2"	steel	2.86	72.6	1.06	26.9	7/8"
1/2"	4FS3	3/8"	steel	3.49	88.6	1.19	30.2	1"
	4FS4	1/2"	steel	3.49	88.6	1.19	30.2	1"
	4FS4-S	1/2"	303 stainless	3.49	88.6	1.19	30.2	1"
	4FS6	3/4"	steel	3.49	88.6	1.19	30.2	1"

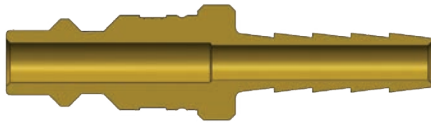

Body Size	DF-Series Industrial Interchange Plug (Standard Hose Barb)							
	Part Detail			Length		Maximum O.D.		Hex Inch
	Part #	Hose I.D.	Material	inch	mm	inch	mm	
1/4"	D2S2	1/4"	steel	2.09	53.1	0.56	14.2	-
	D2S2-B	1/4"	brass	2.09	53.1	0.56	14.2	-
	D2S2-S	1/4"	303 stainless	2.09	53.1	0.56	14.2	-
	D2S2.5	5/16"	steel	2.09	53.1	0.56	14.2	-
	D2S3	3/8"	steel	2.09	53.1	0.56	14.2	-
	D2S3-B	3/8"	brass	2.09	53.1	0.56	14.2	-
3/8"	D3S2	1/4"	steel	2.21	56.1	0.75	19.1	-
	D3S3	3/8"	steel	2.21	56.1	0.75	19.1	-
	D3S3-B	3/8"	brass	2.21	56.1	0.75	19.1	-
	D3S3-S	3/8"	303 stainless	2.21	56.1	0.75	19.1	-
1/2"	D3S4	1/2"	steel	2.21	56.1	0.75	19.1	-
	D4S3	3/8"	steel	2.53	64.3	0.75	19.1	-
	D4S3-B	3/8"	brass	2.53	64.3	0.75	19.1	-
	D4S4	1/2"	steel	2.53	64.3	0.75	19.1	-
	D4S4-B	1/2"	brass	2.53	64.3	0.75	19.1	-
	D4S4-S	1/2"	303 stainless	2.53	64.3	0.75	19.1	-
3/4"	D4S6	3/4"	steel	2.53	64.3	0.94	23.9	-
	D4S6-B	3/4"	brass	2.53	64.3	0.94	23.9	-
	D6S4	1/2"	steel	3.49	88.7	1.52	38.6	-
	D6S6	3/4"	steel	3.49	88.7	1.52	38.6	-
	D6S8	1"	steel	3.49	88.7	1.52	38.6	-

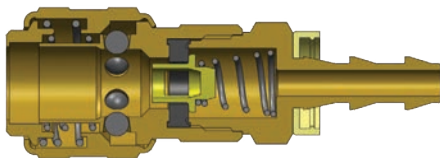

Body Size	D-Series Automatic Industrial Interchange Coupler (Push-Loc Barb)							
	Part Detail			Length		Maximum O.D.		Hex Inch
	Part #	Hose I.D.	Material	inch	mm	inch	mm	
1/4"	2DB2-B	1/4"	brass	2.76	70.1	0.98	24.9	11/16"
	2DB3-B	3/8"	brass	2.77	70.4	0.98	24.9	11/16"
3/8"	3DB3-B	3/8"	brass	2.82	71.7	1.18	30.0	7/8"
1/2"	4DB4-B	1/2"	brass	3.31	84.1	1.34	34.0	1-1/16"

Pneumatic Couplings: DF-Series

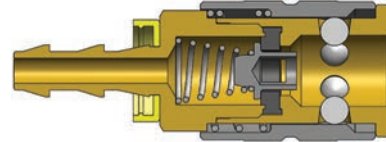
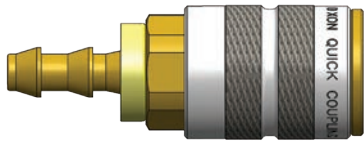

Body Size	F-Series Manual Industrial Interchange Coupler (Push-Loc Barb)							
	Part Detail			Length		Maximum O.D.		Hex Inch
	Part #	Hose I.D.	Material	inch	mm	inch	mm	
1/4"	2FB2-B	1/4"	brass	2.49	63.2	0.88	22.4	3/4"
	2FB3-B	3/8"	brass	2.49	63.2	0.88	22.4	3/4"
3/8"	3FB2	1/4"	steel	2.80	71.1	1.06	26.9	7/8"
	3FB3	3/8"	steel	2.80	71.1	1.06	26.9	7/8"
	3FB4	1/2"	steel	2.80	71.1	1.06	26.9	7/8"
1/2"	4FB3	3/8"	steel	3.40	86.4	1.19	30.2	1"
	4FB4	1/2"	steel	3.40	86.4	1.19	30.2	1"

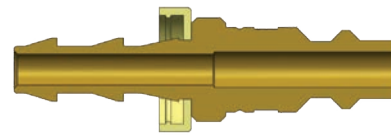
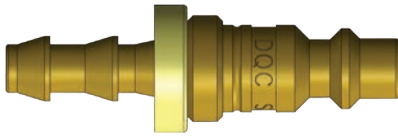

Body Size	DF-Series Industrial Interchange Plug (Push-Loc Barb)							
	Part Detail			Length		Maximum O.D.		Hex Inch
	Part #	Hose I.D.	Material	inch	mm	inch	mm	
1/4"	D2B2	1/4"	steel	2.09	53.1	0.69	17.5	-
	D2B2-B	1/4"	brass	2.09	53.1	0.69	17.5	-
	D2B3	3/8"	steel	2.09	53.1	0.86	21.8	-
3/8"	D3B2	1/4"	steel	2.21	56.1	0.75	19.1	-
	D3B3	3/8"	steel	2.21	56.1	0.75	19.1	-
	D3B4	1/2"	steel	2.35	59.7	0.75	19.1	-
1/2"	D4B4	1/2"	steel	2.67	67.8	0.75	19.1	-
3/4"	D6B6	3/4"	steel	2.99	75.9	1.00	25.4	-

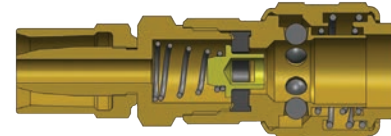

Body Size	D-Series Automatic Industrial Interchange Coupler (Reusable Barb)							
	Part Detail			Length		Maximum O.D.		Hex Inch
	Part #	Hose I.D. x O.D.	Material	inch	mm	inch	mm	
1/4"	2DE2-B	1/4" x 1/2"	brass	2.69	68.3	0.98	24.9	11/16"
	2DH2-B	1/4" x 5/8"	brass	2.79	70.9	0.98	24.9	11/16"
	2DK3-B	3/8" x 11/16"	brass	2.79	70.9	0.98	24.9	11/16"
	2DL3-B	3/8" x 3/4"	brass	2.85	72.4	0.98	24.9	11/16"

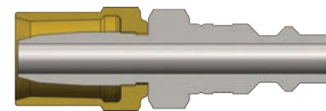
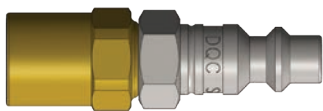

Body Size	DF-Series Industrial Interchange Plug (Reusable Barb)							
	Part Detail			Length		Maximum O.D.		Hex Inch
	Part #	Hose I.D. x O.D.	Material	inch	mm	inch	mm	
1/4"	D2E2	1/4" x 1/2"	steel	2.07	52.6	0.69	17.5	9/16"
	D2H2	1/4" x 5/8"	steel	2.16	54.9	0.81	20.6	9/16"
	D2K3	3/8" x 11/16"	steel	2.16	54.9	0.81	20.6	9/16"
	D2L3	3/8" x 3/4"	steel	2.18	55.4	0.95	24.1	9/16"

Automatic Coupler Operation

The D-Series automatic coupling has been performing reliably and safely for more than 50 years. This amazing coupler is an inexpensive solution for automatically connecting pressurized air lines.

How To Disconnect

Push sleeve toward plug tip.
Do not pull sleeve back.

Push sleeve toward plug.

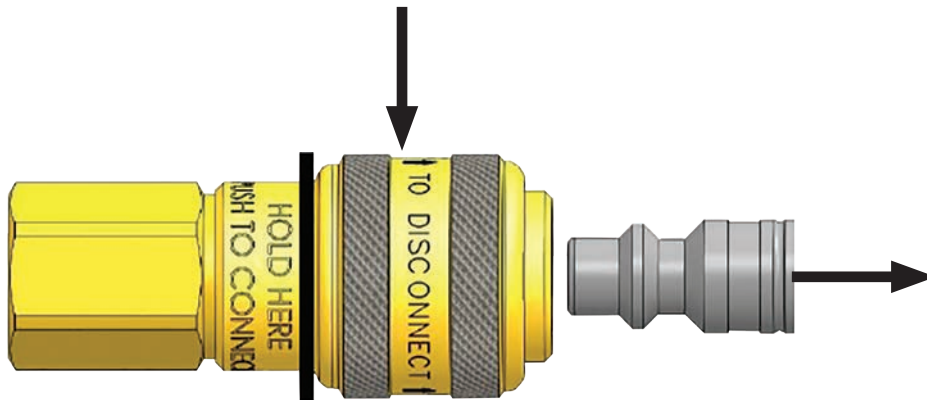

How To Connect

Firmly push plug into socket until you hear a click.
Sleeve does not need to be pulled back.

Hold here.
Do not hold forward of black line.

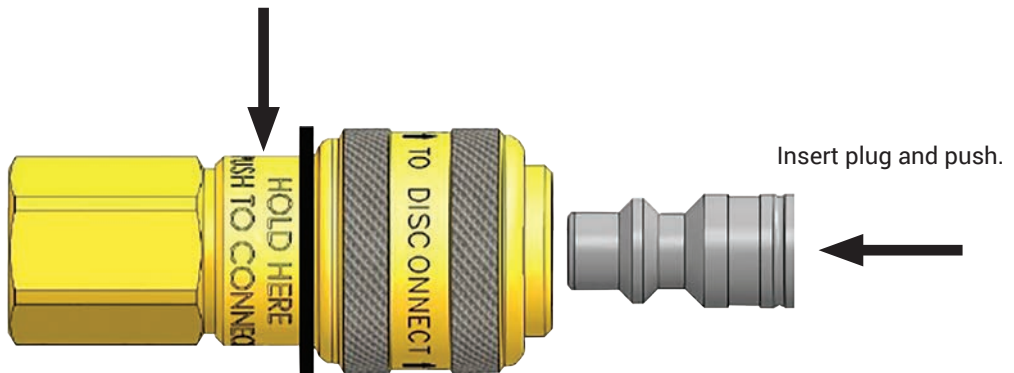

Pneumatic Couplings: J-Series

Interchange Data

- Tru-Flate automotive interchange style
- Parker 10-Series
- Rectus 55KM and Parker 10-Series
- Amflo T-Series

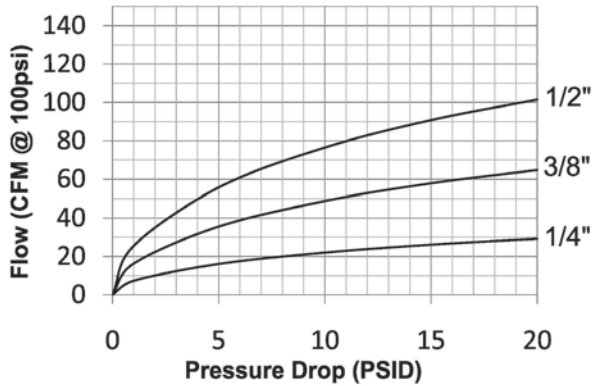

Rated Pressure Chart

Materials

- Machined components are manufactured using solid steel or brass bar stock
- Stainless steel balls, retaining rings, and springs maximize corrosion resistance and extend service life
- Steel componentry is plated using ROHS-compliant trivalent chrome
- 1/4" couplers constructed of brass with steel sleeve and steel tubular valve as standard
- 3/8" and 1/2" couplers constructed of steel as standard with steel tubular valves

Seal Components

- Nitrile seals are standard, providing a temperature range of -40°F to 250°F (-40°C to 121°C)

Body Size	J-Series Automotive Interchange (Connected)															
	Brass Coupler/Steel Plug				Brass Coupler/Plug				Steel Coupler/Plug				303 Stainless Coupler/Plug			
	Max. Working		Burst		Max. Working		Burst		Max. Working		Burst		Max. Working		Burst	
	PSI	Bar	PSI	Bar	PSI	Bar	PSI	Bar	PSI	Bar	PSI	Bar	PSI	Bar	PSI	Bar
1/4"	500	35	11,500	793	300	20	10,500	724	-	-	-	-	-	-	-	-
3/8"	-	-	-	-	-	-	-	-	500	35	18,000	1,241	-	-	-	-
1/2"	-	-	-	-	-	-	-	-	500	35	10,000	690	-	-	-	-

Technical Specifications

Body Size	Interchange Standards				Functional Parameters					
	U.S. Military	U.S. Government	International Standards	ANSI/NFPA Standards	Locking Ball Quantity	Air Inclusion	Fluid Loss	Vacuum Rating	Flow ΔP = 15 PSI	
1/4"	-	-	-	-	6	N/A	N/A	N/R	26 CFM	
3/8"	-	-	-	-	6	N/A	N/A	N/R	58 CFM	
1/2"	-	-	-	-	6	N/A	N/A	N/A	91 CFM	

Available Options

Body Size	Seal Options		Valve Options			Sleeve Options				Treatments
	FKM	EPDM	Unvalved	Brass	303 SS	Flanged	Sleeve-Lock	Brass	303 SS	Oxy-Clean
	Pre	Pre	Suf	Suf	Suf	Suf	Suf	Suf	Suf	Suf
1/4"	F-	P-	-E	-BV	-SV	-FS	-LS	-BS	-XS	-C1
3/8"	F-	N/A	-E	-BV	-SV	N/A	-LS	N/A	-XS	-C1
1/2"	F-	N/A	-E	-BV	-SV	N/A	-LS	N/A	-XS	-C1

! Operating pressure for couplings utilizing hose barb end connections may be dramatically reduced to that of the hose rating and/or hose end connection combination. Consult hose manufacturer's catalog for hose end connection ratings. If in doubt, test under controlled conditions for suitability to application. Dixon Quick Coupling cannot assume liability for misapplication of production resulting in equipment down-time, lost production, and/or personal injury including death.

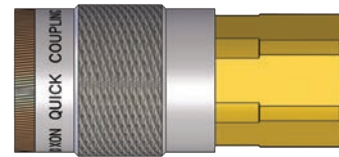
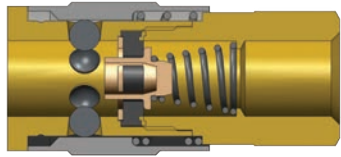

Body Size	J-Series Automotive Interchange Coupler (Female Threads)							
	Part Detail			Length		Maximum O.D.		Hex Inch
	Part #	Threads	Material	inch	mm	inch	mm	
1/4"	2JF1-B	1/8" - 27 NPTF	brass	1.83	46.5	0.88	22.4	3/4"
	2JF2-B	1/4" - 18 NPTF	brass	2.04	51.8	0.88	22.4	3/4"
	2JF3-B	3/8" - 18 NPTF	brass	2.14	54.4	0.88	22.4	13/16"
3/8"	3JF2	1/4" - 18 NPTF	steel	2.25	57.2	1.06	26.9	7/8"
	3JF3	3/8" - 18 NPTF	steel	2.48	63.0	1.06	26.9	7/8"
	3JF4	1/2" - 14 NPTF	steel	2.61	66.3	1.06	26.9	1"
1/2"	4FF3	3/8" - 18 NPTF	steel	2.85	72.5	1.24	31.4	1"
	4FF4	1/2" - 14 NPTF	steel	3.06	77.8	1.24	31.4	1"
	4FF6	3/4" - 14 NPTF	steel	3.15	79.9	1.24	31.4	1-3/16"

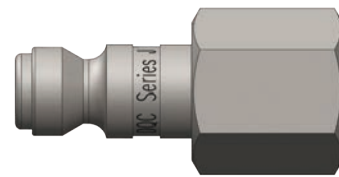
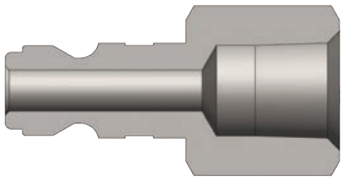

Body Size	J-Series Automotive Interchange Plug (Female Threads)							
	Part Detail			Length		Maximum O.D.		Hex Inch
	Part #	Threads	Material	inch	mm	inch	mm	
1/4"	J2F1	1/8" - 27 NPTF	steel	1.34	34.0	0.65	16.5	9/16"
	J2F2	1/4" - 18 NPTF	steel	1.56	39.6	0.79	20.1	11/16"
	J2F2-B	1/4" - 18 NPTF	brass	1.56	39.6	0.79	20.1	11/16"
	J2F3	3/8" - 18 NPTF	steel	1.56	39.6	1.01	25.7	7/8"
3/8"	J3F2	1/4" - 18 NPTF	steel	1.75	44.5	0.79	20.1	11/16"
	J3F3	3/8" - 18 NPTF	steel	1.75	44.5	1.01	25.7	7/8"
	J3F4	1/2" - 14 NPTF	steel	1.91	48.5	1.16	29.5	1"
1/2"	J4F3	3/8" - 18 NPTF	steel	2.11	53.6	1.01	25.7	7/8"
	J4F4	1/2" - 14 NPTF	steel	2.26	57.4	1.16	29.5	1"
	J4F6	3/4" - 14 NPTF	steel	2.31	58.7	1.37	34.8	1-3/16"

Pneumatic Couplings: J-Series

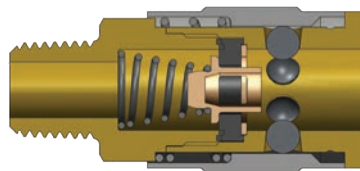
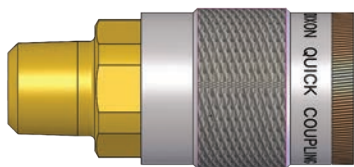

Body Size	J-Series Automotive Interchange Coupler (Male Threads)							
	Part Detail			Length		Maximum O.D.		Hex Inch
	Part #	Threads	Material	inch	mm	inch	mm	
1/4"	2JM1-B	1/8" - 27 NPTF	brass	1.88	47.8	0.88	22.4	3/4"
	2JM2-B	1/4" - 18 NPTF	brass	2.05	52.0	0.88	22.4	3/4"
	2JM3-B	3/8" - 18 NPTF	brass	2.08	52.8	0.88	22.4	3/4"
3/8"	3JM2	1/4" - 18 NPTF	steel	2.45	62.2	1.06	26.9	7/8"
	3JM3	3/8" - 18 NPTF	steel	2.46	62.5	1.06	26.9	7/8"
	3JM4	1/2" - 14 NPTF	steel	2.55	64.8	1.06	26.9	7/8"
1/2"	4FM3	3/8" - 18 NPTF	steel	2.97	75.4	1.19	30.2	1"
	4FM4	1/2" - 14 NPTF	steel	3.07	78.0	1.19	30.2	1"
	4FM6	3/4" - 14 NPTF	steel	3.12	79.2	1.19	30.2	1-1/16"

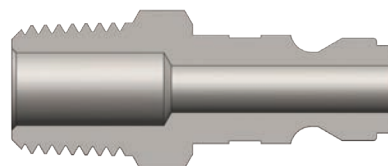

Body Size	J-Series Automotive Interchange Plug (Male Threads)							
	Part Detail			Length		Maximum O.D.		Hex Inch
	Part #	Threads	Material	inch	mm	inch	mm	
1/4"	J2M1	1/8" - 27 NPTF	steel	1.47	37.3	0.58	14.7	1/2"
	J2M2	1/4" - 18 NPTF	steel	1.59	40.4	0.65	16.5	9/16"
	J2M2-B	1/4" - 18 NPTF	brass	1.59	40.4	0.65	16.5	9/16"
	J2M3	3/8" - 18 NPTF	steel	1.65	41.9	0.79	20.1	3/4"
3/8"	J3M2	1/4" - 18 NPTF	steel	1.78	45.2	0.79	20.1	11/16"
	J3M3	3/8" - 18 NPTF	steel	1.84	46.7	0.79	20.1	3/4"
	J3M4	1/2" - 14 NPTF	steel	2.00	50.8	1.01	25.7	7/8"
1/2"	J4M3	3/8" - 18 NPTF	steel	2.20	55.9	0.79	20.1	11/16"
	J4M4	1/2" - 14 NPTF	steel	2.35	59.7	1.01	25.7	7/8"
	J4M6	3/4" - 14 NPTF	steel	2.51	63.8	1.23	31.2	1-1/16"

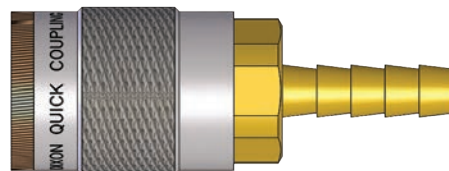
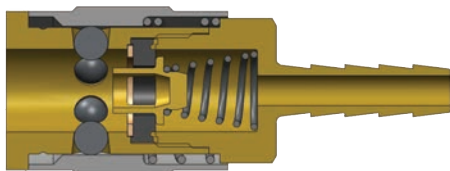

Body Size	J-Series Automotive Interchange Coupler (Standard Hose Barb)							
	Part Detail			Length		Maximum O.D.		Hex Inch
	Part #	Hose I.D.	Material	inch	mm	inch	mm	
1/4"	2JS2-B	1/4"	brass	2.53	64.3	0.88	22.4	3/4"
	2JS3-B	3/8"	brass	2.53	64.3	0.88	22.4	3/4"
3/8"	3JS2	1/4"	steel	2.86	72.6	1.06	26.9	7/8"
	3JS3	3/8"	steel	2.86	72.6	1.06	26.9	7/8"
	3JS4	1/2"	steel	2.86	72.6	1.06	26.9	7/8"
1/2"	4FS3	3/8"	steel	3.49	88.6	1.19	30.2	1"
	4FS4	1/2"	steel	3.49	88.6	1.19	30.2	1"
	4FS6	3/4"	steel	3.49	88.6	1.19	30.2	1"

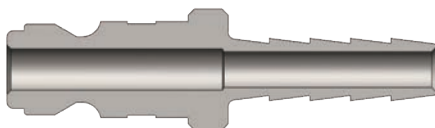

Body Size	J-Series Automotive Interchange Plug (Standard Hose Barb)							
	Part Detail			Length		Maximum O.D.		Hex Inch
	Part #	Hose I.D.	Material	inch	mm	inch	mm	
1/4"	J2S2	1/4"	steel	1.99	50.5	0.56	14.2	-
	J2S3	3/8"	steel	1.99	50.5	0.56	14.2	-
3/8"	J3S2	1/4"	steel	2.18	55.4	0.75	19.1	-
	J3S3	3/8"	steel	2.18	55.4	0.75	19.1	-
	J3S4	1/2"	steel	2.18	55.4	0.75	19.1	-
1/2"	J4S3	3/8"	steel	2.54	64.5	0.75	19.1	-
	J4S4	1/2"	steel	2.54	64.5	0.75	19.1	-
	J4S6	3/4"	steel	2.54	64.5	0.94	23.9	-

Pneumatic Couplings: J-Series

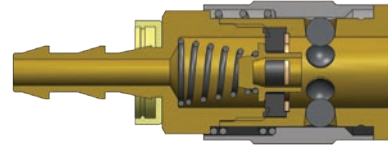
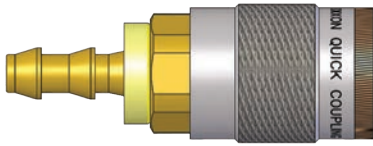

Body Size	J-Series Automotive Interchange Coupler (Push-Loc Barb)							
	Part Detail			Length		Maximum O.D.		Hex Inch
	Part #	Hose I.D.	Material	inch	mm	inch	mm	
1/4"	2JB2-B	1/4"	brass	2.37	60.2	0.88	22.4	3/4"
	2JB3-B	3/8"	brass	2.49	63.2	0.88	22.4	3/4"
3/8"	3JB2	1/4"	steel	2.80	71.1	1.06	26.9	7/8"
	3JB3	3/8"	steel	2.80	71.1	1.06	26.9	7/8"
	3JB4	1/2"	steel	2.80	71.1	1.06	26.9	7/8"
1/2"	4FB3	3/8"	steel	3.40	86.4	1.19	30.2	1"
	4FB4	1/2"	steel	3.40	86.4	1.19	30.2	1"

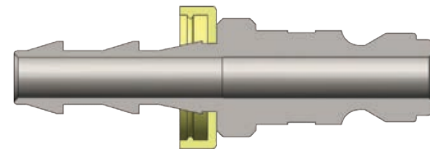
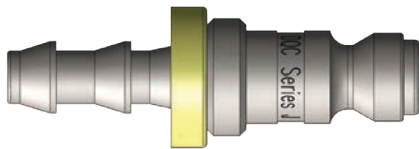

Body Size	J-Series Automotive Interchange Plug (Push-Loc Barb)							
	Part Detail			Length		Maximum O.D.		Hex Inch
	Part #	Hose I.D.	Material	inch	mm	inch	mm	
1/4"	J2B2	1/4"	steel	2.09	53.1	0.69	17.5	-
	J2B3	3/8"	steel	2.09	53.1	0.86	21.8	-
3/8"	J3B3	3/8"	steel	2.21	56.1	0.75	19.1	-
1/2"	J4B4	1/2"	steel	2.67	67.8	0.75	19.1	-

J Series Profiles

Body Size	A	B
1/4"	0.42	0.06
3/8"	0.56	0.13
1/2"	0.65	0.13

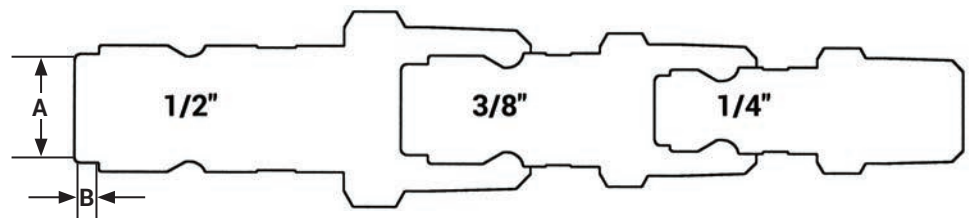

Pneumatic Couplings: M-Series

Interchange Data

- ARO 210 (1/4") and ARO 310 (3/8") interchange
- Automatic couplings interchange with ARO 210/310 and Hansen Series 210/310
- Manual couplings interchange with Parker 50-Series and Amflo type B

Materials

- Machined components are manufactured using solid steel or brass bar stock.
- Stainless steel springs; carbon steel balls, retaining rings, and pins
- Steel componentry is plated using ROHS-compliant trivalent chrome
- Automatic couplers constructed of steel
- Manual couplers constructed of brass

Seal Components

- Nitrile seals are standard, providing a temperature range of -40°F to 250°F (-40°C to 121°C)

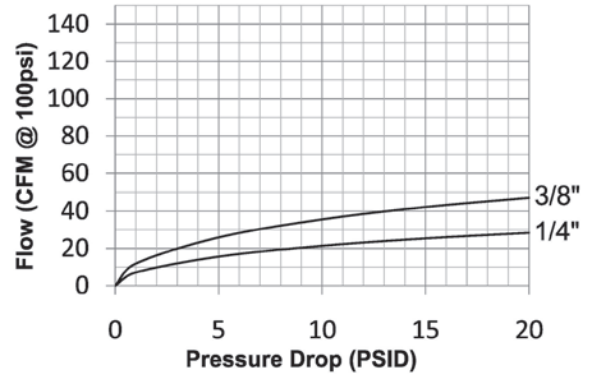

Rated Pressure Chart

Body Size	M-Series ARO Interchange (Connected)															
	Auto Coupler/Steel Plug				Auto Coupler/Brass Plug				Manual Coupler/Steel Plug				Manual Coupler/Brass Plug			
	Max. Working		Burst		Max. Working		Burst		Max. Working		Burst		Max. Working		Burst	
	PSI	Bar	PSI	Bar	PSI	Bar	PSI	Bar	PSI	Bar	PSI	Bar	PSI	Bar	PSI	Bar
1/4"	300	20	2,600	179	300	20	5,000	345	300	20	12,400	855	300	20	12,700	876
3/8"	300	20	3,300	228	-	-	-	-	-	-	-	-	-	-	-	-

Technical Specifications

Body Size	Interchange Standards				Functional Parameters					
	U.S. Military	U.S. Government	International Standards	ANSI/NFPA Standards	Locking Mechanism	Air Inclusion	Fluid Loss	Vacuum Rating	Flow ΔP = 15 PSI	
1/4"	-	-	-	-	Manual - 4 Ball	N/A	N/A	N/R	25 CFM	
	-	-	-	-	Auto - Pins	N/A	N/A	N/R	22 CFM	
3/8"	-	-	-	-	Auto - Pins	N/A	N/A	N/R	42 CFM	

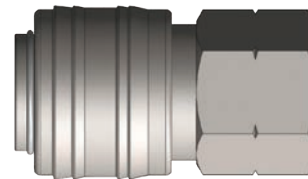
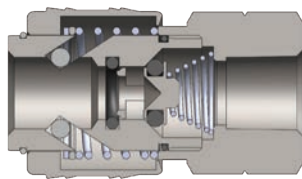

Body Size	M-Series Automatic ARO Interchange Coupler (Female Threads)							
	Part Detail			Length		Maximum O.D.		Hex Inch
	Part #	Threads	Material	inch	mm	inch	mm	
1/4"	2MF2-PL	1/4" - 18 NPT	steel/brass	1.72	43.6	1.06	27.0	13/16"
	2MF3-PL	3/8" - 18 NPT	steel/brass	1.72	43.6	1.06	27.0	13/16"
3/8"	3MF3-PL	3/8" - 18 NPT	steel/brass	1.93	49.0	1.26	32.0	1-1/16"

Pneumatic Couplings: M-Series

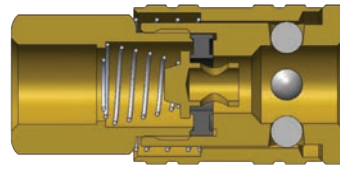
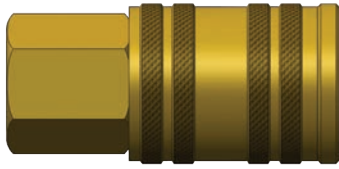

M-Series Manual ARO Interchange Coupler (Female Threads)

Body Size	M-Series Manual ARO Interchange Coupler (Female Threads)							
	Part Detail			Length		Maximum O.D.		Hex Inch
	Part #	Threads	Material	inch	mm	inch	mm	
1/4"	2MF2-B	1/4" - 18 NPT	brass	1.97	50.0	0.87	22.0	3/4"
	2MF3-B	3/8" - 18 NPT	brass	2.05	52.0	0.87	22.0	13/16"

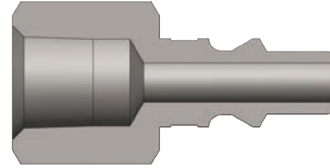
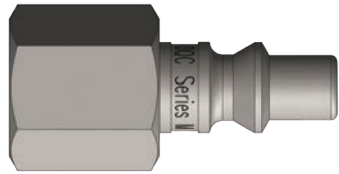

M-Series ARO Interchange Plug (Female Threads)

Body Size	M-Series ARO Interchange Plug (Female Threads)							
	Part Detail			Length		Maximum O.D.		Hex Inch
	Part #	Threads	Material	inch	mm	inch	mm	
1/4"	M2F2	1/4" - 18 NPTF	steel	1.57	39.9	0.79	20.1	11/16"
	M2F2-B	1/4" - 18 NPTF	brass	1.57	39.9	0.79	20.1	11/16"
	M2F3	3/8" - 18 NPTF	steel	1.57	39.9	1.01	25.7	7/8"
3/8"	M3F3	3/8" - 18 NPTF	steel	1.82	46.2	1.01	25.7	7/8"

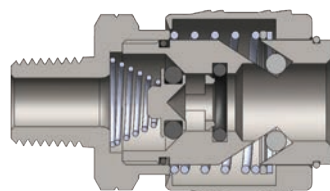
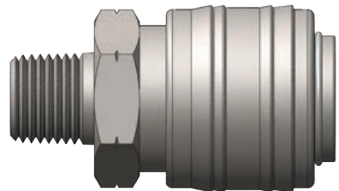

M-Series Automatic ARO Interchange Coupler (Male Threads)

Body Size	M-Series Automatic ARO Interchange Coupler (Male Threads)							
	Part Detail			Length		Maximum O.D.		
	Part #	Threads	Material	inch	mm	inch	mm	
1/4"	2MM2-PL	1/4" - 18 NPT	steel/brass	1.70	43.2	1.06	27.0	
	2MM3-PL	3/8" - 18 NPT	steel/brass	1.80	45.6	1.06	27.0	
3/8"	3MM3-PL	3/8" - 18 NPT	steel/brass	1.89	48.0	1.26	32.0	
	3MM4-PL	1/2" - 14 NPTF	steel/brass	1.89	48.0	1.26	32.0	

M Series Profiles

Body Size	A	B
1/4"	0.31	0.33
3/8"	0.43	0.59

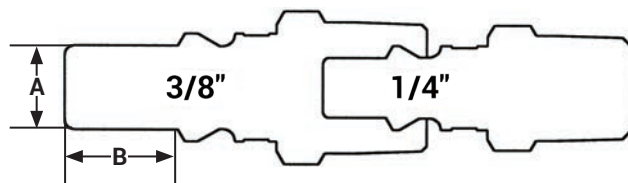

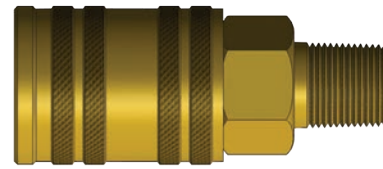
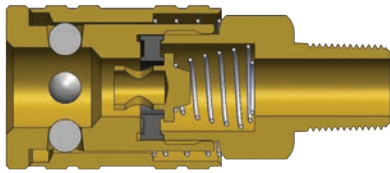

Body Size	M-Series Manual ARO Interchange Coupler (Male Threads)							
	Part Detail			Length		Maximum O.D.		Hex Inch
	Part #	Threads	Material	inch	mm	inch	mm	
1/4"	2MM2-B	1/4" - 18 NPT	brass	2.13	54.0	0.87	22.0	3/4"
	2MM3-B	3/8" - 18 NPT	brass	2.13	54.0	0.87	22.0	13/16"

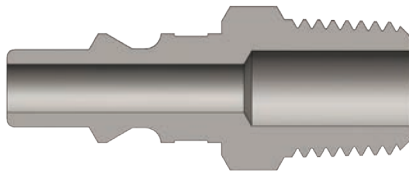

Body Size	M-Series ARO Interchange Plug (Male Threads)							
	Part Detail			Length		Maximum O.D.		Hex Inch
	Part #	Threads	Material	inch	mm	inch	mm	
1/4"	M2M1	1/8" - 27 NPTF	steel	1.48	37.6	0.58	14.7	1/2"
	M2M2	1/4" - 18 NPTF	steel	1.60	40.6	0.65	16.5	9/16"
	M2M2-B	1/4" - 18 NPTF	brass	1.60	40.6	0.65	16.5	9/16"
	M2M3	3/8" - 18 NPTF	steel	1.80	45.7	0.79	20.1	3/4"
3/8"	M3M3	3/8" - 18 NPTF	steel	1.91	48.5	0.79	20.1	3/4"

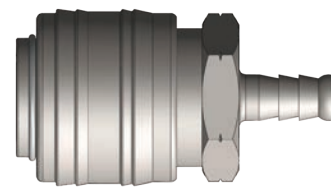
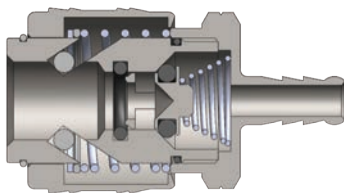

Body Size	M-Series Automatic ARO Interchange Coupler (Standard Hose Barb)							
	Part Detail			Length		Maximum O.D.		Hex Inch
	Part #	Hose I.D.	Material	inch	mm	inch	mm	
1/4"	2MS2-PL	1/4"	steel/brass	1.91	48.6	1.06	27.0	13/16"
	2MS2.5-PL	5/16"	steel/brass	2.33	59.1	1.06	27.0	13/16"
	2MS3-PL	3/8"	steel/brass	2.50	63.6	1.06	27.0	13/16"
3/8"	3MS3-PL	3/8"	steel/brass	2.60	66.0	1.26	32.0	1-1/16"

Pneumatic Couplings: M-Series

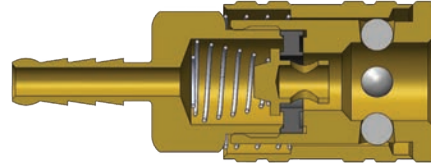
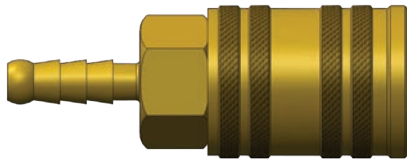

Body Size	M-Series Manual ARO Interchange Coupler (Standard Hose Barb)							
	Part Detail			Length		Maximum O.D.		Hex Inch
	Part #	Hose I.D.	Material	Inch	mm	Inch	mm	
1/4"	2MS2-B	1/4"	brass	2.36	60.0	0.87	22.0	3/4"
	2MS3-B	3/8"	brass	2.76	70.0	0.87	22.0	13/16"

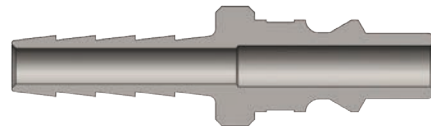
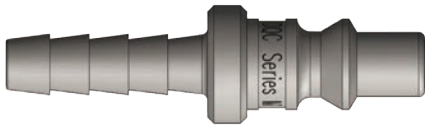

Body Size	M-Series ARO Interchange Plug (Standard Hose Barb)							
	Part Detail			Length		Maximum O.D.		Hex Inch
	Part #	Hose I.D.	Material	Inch	mm	Inch	mm	
1/4"	M2S2	1/4"	steel	2.00	50.8	0.56	14.2	-
	M2S3	3/8"	steel	2.00	50.8	0.56	14.2	-
3/8"	M3S3	3/8"	steel	2.25	57.2	0.88	22.4	-

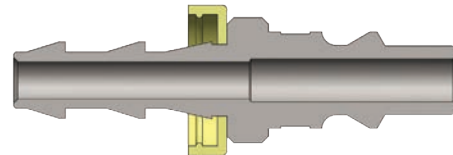

Body Size	M-Series ARO Interchange Plug (Push-Loc Barb)							
	Part Detail			Length		Maximum O.D.		Hex Inch
	Part #	Hose I.D.	Material	Inch	mm	Inch	mm	
1/4"	M2B2	1/4"	steel	2.09	53.1	0.69	17.5	-

! It is important to be safe when installing quick disconnect couplings into a pneumatic circuit. Never install a pneumatic coupling directly into an air tool. Use a piece of hose that is at least 18" long between the tool and the coupling to prevent damage to the coupling. To protect the operator, safety devices such as a safety check valve and safety cable should be installed in case there is a hose or coupling failure.

Interchange Data

- European High-flow Interchange
- 1/4" interchanges with Coilhose Megaflow, CEJN 320, and Rectus 25KA/26KA
- 3/8" interchanges with Rectus 27KA and CEJN 410

Materials

- Machined components are manufactured using solid steel or brass bar stock
- Stainless steel springs, carbon steel balls and retaining rings
- Steel componentry is plated using ROHS-compliant trivalent chrome

Seal Components

- Nitrile pneumatically energized seals are standard, providing a temperature range of **-40°F to 250°F** (-40°C to 121°C)

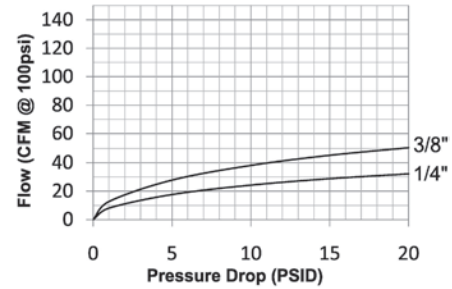

Rated Pressure Chart

Body Size	CJ-Series European High-Flow Interchange (Connected)							
	Brass Coupler/Steel Plug				Brass Coupler/Plug			
	Maximum Working		Burst		Maximum Working		Burst	
	PSI	Bar	PSI	Bar	PSI	Bar	PSI	Bar
1/4"	300	20	9,500	655	300	20	7,200	500
3/8"	300	20	8,000	552	300	20	4,400	300

Technical Specifications

Body Size	Interchange Standards				Functional Parameters				
	U.S. Military	U.S. Government	International Standards	ANSI/NFPA Standards	Locking Ball Quantity	Air Inclusion	Fluid Loss	Vacuum Rating	Flow ΔP = 15 PSI
1/4"	-	-	-	-	6	N/A	N/A	N/R	37 CFM
3/8"	-	-	-	-	6	N/A	N/A	N/R	67 CFM

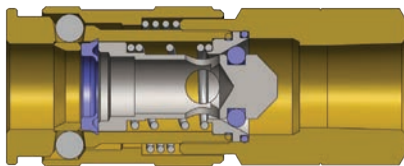

Body Size	CJ-Series European Interchange Coupler (Female Threads)							
	Part Detail			Length		Maximum O.D.		Hex Inch
	Part #	Threads	Material	Inch	mm	Inch	mm	
1/4"	2CJF2-B	1/4" - 18 NPT	brass	2.32	59.0	0.92	23.4	3/4"
	2CJBF2-B	1/4" - 19 BSPP	brass	2.32	59.0	0.92	23.4	3/4"
	2CJF3-B	3/8" - 18 NPT	brass	2.32	59.0	0.92	23.4	3/4"
	2CJBF3-B	3/8" - 19 BSPP	brass	2.32	59.0	0.92	23.4	3/4"
3/8"	3CJF3-B	3/8" - 18 NPT	brass	2.54	64.5	1.09	27.7	15/16"
	3CJBF3-B	3/8" - 19 BSPP	brass	2.54	64.5	1.09	27.7	15/16"
	3CJF4-B	1/2" - 14 NPT	brass	2.68	68.0	1.09	27.7	15/16"
	3CJBF4-B	1/2" - 14 BSPP	brass	2.68	68.0	1.09	27.7	15/16"

Pneumatic Couplings: CJ-Series

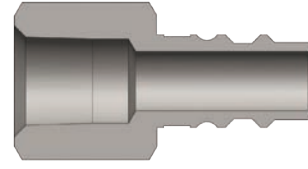
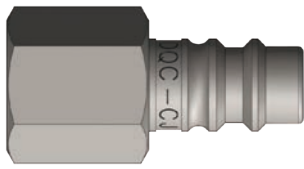

CJ-Series European Interchange Plug (Female Threads)

Body Size	CJ-Series European Interchange Plug (Female Threads)							
	Part Detail			Length		Maximum O.D.		Hex Inch
	Part #	Threads	Material	inch	mm	inch	mm	
1/4"	CJ2F2-LG	1/4" - 18 NPT	steel	1.42	36.0	0.79	20.1	11/16"
	CJ2F2-B	1/4" - 18 NPT	brass	1.42	36.0	0.79	20.1	11/16"
	CJ2BF2-LG	1/4" - 19 BSPP	steel	1.42	36.0	0.79	20.1	11/16"
	CJ2BF2-B	1/4" - 19 BSPP	brass	1.42	36.0	0.79	20.1	11/16"
	CJ2F3-LG	3/8" - 18 NPT	steel	1.48	37.5	1.01	25.7	7/8"
	CJ2F3-B	3/8" - 18 NPT	brass	1.48	37.5	1.01	25.7	7/8"
	CJ2BF3-LG	3/8" - 19 BSPP	steel	1.48	37.5	1.01	25.7	7/8"
	CJ2BF3-B	3/8" - 19 BSPP	brass	1.48	37.5	1.01	25.7	7/8"
3/8"	CJ3F3	3/8" - 18 NPT	steel	1.50	38.0	1.01	25.7	7/8"
	CJ3F3-B	3/8" - 18 NPT	brass	1.50	38.0	1.01	25.7	7/8"
	CJ3BF3	3/8" - 19 BSPP	steel	1.50	38.0	1.01	25.7	7/8"
	CJ3BF3-B	3/8" - 19 BSPP	brass	1.50	38.0	1.01	25.7	7/8"
	CJ3F4	1/2" - 14 NPT	steel	1.71	43.5	1.16	29.5	1"
	CJ3F4-B	1/2" - 14 NPT	brass	1.71	43.5	1.16	29.5	1"
	CJ3BF4	1/2" - 14 BSPP	steel	1.71	43.5	1.16	29.5	1"
	CJ3BF4-B	1/2" - 14 BSPP	brass	1.71	43.5	1.16	29.5	1"

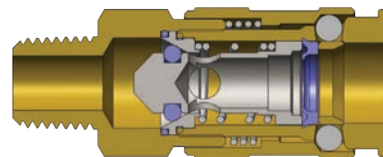
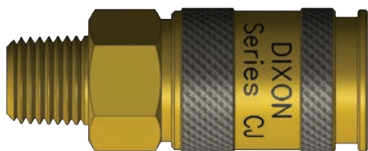

CJ-Series European Interchange Coupler (Male Threads)

Body Size	CJ-Series European Interchange Coupler (Male Threads)							
	Part Detail			Length		Maximum O.D.		Hex Inch
	Part #	Threads	Material	inch	mm	inch	mm	
1/4"	2CJM2-B	1/4" - 18 NPT	brass	2.44	62.0	0.92	23.4	3/4"
	2CJBM2-B	1/4" - 19 BSPT	brass	2.44	62.0	0.92	23.4	3/4"
	2CJM3-B	3/8" - 18 NPT	brass	2.44	62.0	0.92	23.4	3/4"
	2CJBM3-B	3/8" - 19 BSPT	brass	2.44	62.0	0.92	23.4	3/4"
3/8"	3CJM3-B	3/8" - 18 NPT	brass	2.64	67.0	1.09	27.7	15/16"
	3CJBM3-B	3/8" - 19 BSPT	brass	2.64	67.0	1.09	27.7	15/16"
	3CJM4-B	1/2" - 14 NPT	brass	2.76	70.0	1.09	27.7	15/16"
	3CJBM4-B	1/2" - 14 BSPT	brass	2.76	70.0	1.09	27.7	15/16"

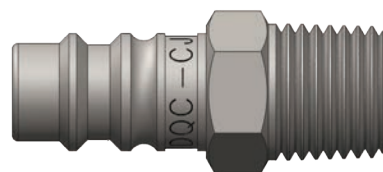
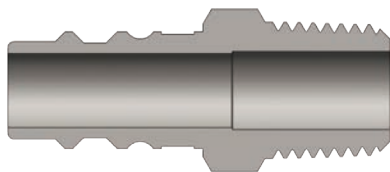

Body Size	CJ-Series European Interchange Plug (Male Threads)							
	Part Detail			Length		Maximum O.D.		Hex Inch
	Part #	Threads	Material	inch	mm	inch	mm	
1/4"	CJ2M2-LG	1/4" - 18 NPT	steel	1.48	37.5	0.65	16.5	9/16"
	CJ2M2-B	1/4" - 18 NPT	brass	1.48	37.5	0.65	16.5	9/16"
	CJ2BM2-LG	1/4" - 19 BSPT	steel	1.48	37.5	0.65	16.5	9/16"
	CJ2BM2-B	1/4" - 19 BSPT	brass	1.48	37.5	0.65	16.5	9/16"
	CJ2M3-LG	3/8" - 18 NPT	steel	1.56	39.5	0.79	20.1	11/16"
	CJ2M3-B	3/8" - 18 NPT	brass	1.56	39.5	0.79	20.1	11/16"
	CJ2BM3-LG	3/8" - 19 BSPT	steel	1.56	39.5	0.79	20.1	11/16"
	CJ2BM3-B	3/8" - 19 BSPT	brass	1.56	39.5	0.79	20.1	11/16"
3/8"	CJ3M3	3/8" - 18 NPT	steel	1.57	40.0	0.79	20.1	11/16"
	CJ3M3-B	3/8" - 18 NPT	brass	1.57	40.0	0.79	20.1	11/16"
	CJ3BM3	3/8" - 19 BSPT	steel	1.57	40.0	0.79	20.1	11/16"
	CJ3BM3-B	3/8" - 19 BSPT	brass	1.57	40.0	0.79	20.1	11/16"
	CJ3M4	1/2" - 14 NPT	steel	1.81	46.0	1.01	25.7	7/8"
	CJ3M4-B	1/2" - 14 NPT	brass	1.81	46.0	1.01	25.7	7/8"
	CJ3BM4	1/2" - 14 BSPT	steel	1.81	46.0	1.01	25.7	7/8"
	CJ3BM4-B	1/2" - 14 BSPT	brass	1.81	46.0	1.01	25.7	7/8"

CJ Series Profiles

Body Size	A	B
1/4"	0.39	0.19
3/8"	0.51	0.81

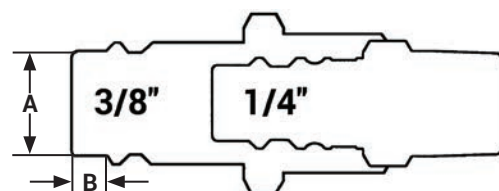

Pneumatic Couplings: SHD-Series

Interchange Data

- Schrader Twist-Lock Interchange
- Parker Twist-Lock, Foster SHD

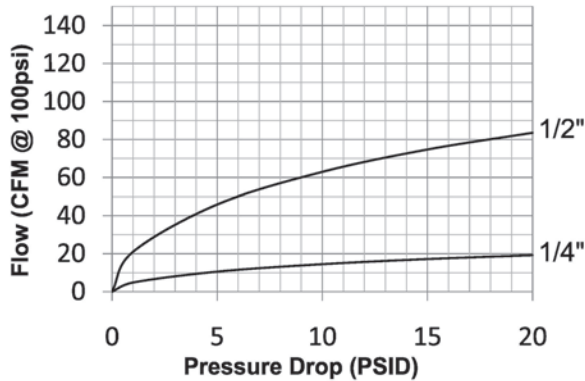

Materials

- Machined components are manufactured using solid steel, brass, or aluminum bar stock
- Stainless steel toggle-pawls and springs, carbon steel retaining rings
- Steel componentry is plated using ROHS-compliant trivalent chrome
- Adapter components are constructed of brass
- Sleeves are constructed of steel

Seal Components

- Nitrile seals are standard providing a temperature range of -40°F to 250°F (-40°C to 121°C)

Rated Pressure Chart

Body Size	SHD-Series Twist-Lock Interchange (Connected)			
	Coupler/Steel Plug			
	Maximum Working		Burst	
	PSI	Bar	PSI	Bar
1/4"	300	20	6,500	448
1/2"	300	20	13,400	924

Technical Specifications

Body Size	Interchange Standards				Functional Parameters				
	U.S. Military	U.S. Government	International Standards	ANSI/NFPA Standards	Locking Mechanism	Air Inclusion	Fluid Loss	Vacuum Rating	Flow ΔP = 15 PSI
1/4"	-	-	-	-	toggle-pawls	N/A	N/A	N/R	17 CFM
1/2"	-	-	-	-	toggle-pawls	N/A	N/A	N/R	75 CFM

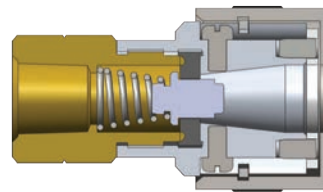

Body Size	SHD-Series Twist-Lock Interchange Coupler (Female Threads)							
	Part Detail			Length		Maximum O.D.		Hex Inch
	Part #	Threads	Material	inch	mm	inch	mm	
1/4"	2SHDF2	1/4" - 18 NPT	aluminum	2.10	53.3	1.12	28.4	11/16"
	2SHDF3	3/8" - 18 NPT	aluminum	2.18	55.4	1.12	28.4	11/16"
1/2"	4SHDF3	3/8" - 18 NPT	aluminum	2.59	65.8	1.50	38.1	1-1/8"
	4SHDF4	1/2" - 14 NPT	aluminum	2.66	67.6	1.50	38.1	1-1/8"
	4SHDF6	3/4" - 14 NPT	aluminum	2.81	71.4	1.50	38.1	1-1/8"



Body Size	SHD-Series Twist-Lock Interchange Plug (Female Threads)							
	Part Detail			Length		Maximum O.D.		Hex Inch
	Part #	Threads	Material	inch	mm	inch	mm	
1/4"	SHD2F1	1/8" - 27 NPT	steel	1.49	37.9	0.79	20.1	11/16"
	SHD2F2	1/4" - 18 NPT	steel	1.62	41.2	0.79	20.1	11/16"
1/2"	SHD4F3	3/8" - 18 NPT	steel	1.79	45.5	1.01	25.7	7/8"



Body Size	SHD-Series Twist-Lock Interchange Coupler (Male Threads)							
	Part Detail			Length		Maximum O.D.		Hex Inch
	Part #	Threads	Material	inch	mm	inch	mm	
1/4"	2SHDM2	1/4" - 18 NPT	aluminum	2.22	56.4	1.12	28.4	11/16"
	2SHDM3	3/8" - 18 NPT	aluminum	2.28	57.9	1.12	28.4	11/16"
1/2"	4SHDM3	3/8" - 18 NPT	aluminum	2.55	64.8	1.50	38.1	1-1/8"
	4SHDM4	1/2" - 14 NPT	aluminum	2.61	66.3	1.50	38.1	1-1/8"



Body Size	SHD-Series Twist-Lock Interchange Plug (Male Threads)							
	Part Detail			Length		Maximum O.D.		Hex Inch
	Part #	Threads	Material	inch	mm	inch	mm	
1/4"	SHD2M1	1/8" - 27 NPT	steel	1.54	39.1	0.79	20.1	11/16"
	SHD2M2	1/4" - 18 NPT	steel	1.72	43.7	0.79	20.1	11/16"
1/2"	SHD4M3	3/8" - 18 NPT	steel	1.81	46.0	1.01	25.7	7/8"
	SHD4M4	1/2" - 14 NPT	steel	1.87	47.5	1.01	25.7	7/8"

Pneumatic Couplings: SHD-Series



Body Size	SHD-Series Twist-Lock Interchange Coupler (Standard Hose Barb)							
	Part Detail			Length		Maximum O.D.		Hex Inch
	Part #	Hose I.D.	Material	Inch	mm	Inch	mm	
1/4"	2SHDS2	1/4"	aluminum	2.54	64.5	1.12	28.4	11/16"
	2SHDS3	3/8"	aluminum	2.67	67.8	1.12	28.4	11/16"
1/2"	4SHDS3	3/8"	aluminum	2.99	76.0	1.50	38.1	1-1/8"
	4SHDS4	1/2"	aluminum	4.23	107.4	1.50	38.1	1-1/8"



Body Size	SHD-Series Twist-Lock Interchange Plug (Standard Hose Barb)							
	Part Detail			Length		Maximum O.D.		Hex Inch
	Part #	Hose I.D.	Material	Inch	mm	Inch	mm	
1/4"	SHD2S2	1/4"	steel	2.03	51.6	0.65	16.5	-
	SHD2S3	3/8"	steel	2.22	56.4	0.65	16.5	-
1/2"	SHD4S3	3/8"	steel	2.34	59.4	0.80	20.3	-
	SHD4S4	1/2"	steel	2.53	64.3	0.80	20.3	-

SHD Series Profiles

Body Size	A	B
1/4"	0.32	0.75
3/8"	0.50	0.75

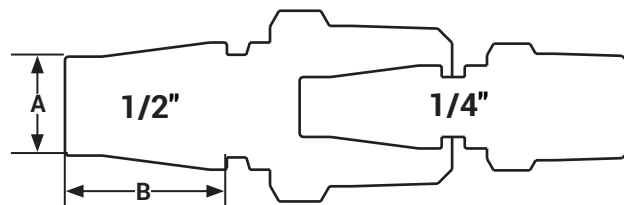

! Operating pressure for couplings utilizing hose barb end connections may be dramatically reduced to that of the hose rating and/or hose end connection combination. Consult hose manufacturer's catalog for hose end connection ratings. If in doubt, test under controlled conditions for suitability to application. Dixon Quick Coupling cannot assume liability for misapplication of production resulting in equipment down-time, lost production, and/or personal injury including death.

Interchange Data

- Lincoln Long-nose Automotive Interchange
- Parker 70-Series, Coilhose Type-17

Materials

- Machined components are manufactured using solid brass or steel bar stock.
- Stainless steel springs, carbon steel balls and retaining rings
- Steel componentry is plated using ROHS-compliant trivalent chrome

Seal Components

- Nitrile seals are standard, providing a temperature range of -40°F to 250°F (-40°C to 121°C)

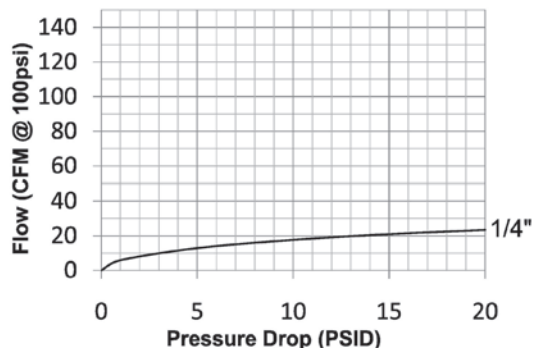

Rated Pressure Chart

Body Size	L-Series Lincoln Interchange (Connected)			
	Brass Coupler/Steel Plug			
	Maximum Working		Burst	
	PSI	Bar	PSI	Bar
1/4"	300	21	5,000	345

Technical Specifications

Body Size	Interchange Standards				Functional Parameters				
	U.S. Military	U.S. Government	International Standards	ANSI/NFPA Standards	Locking Ball Quantity	Air Inclusion	Fluid Loss	Vacuum Rating	Flow ΔP = 15 PSI
1/4"	-	-	-	-	4	N/A	N/A	N/R	21 CFM

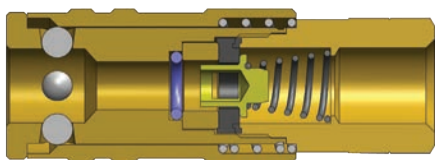

Body Size	L-Series Lincoln Interchange Coupler (Female Threads)							
	Part Detail			Length		Maximum O.D.		Hex Inch
	Part #	Threads	Material	Inch	mm	Inch	mm	
1/4"	2LF2-B	1/4" - 18 NPT	brass	2.40	61.0	0.90	22.9	3/4"

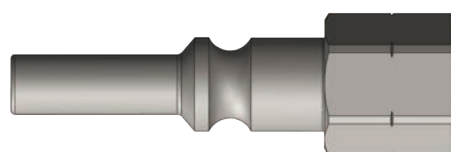
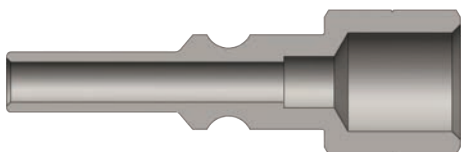

Body Size	L-Series Lincoln Interchange Plug (Female Threads)							
	Part Detail			Length		Maximum O.D.		Hex Inch
	Part #	Threads	Material	Inch	mm	Inch	mm	
1/4"	L2F2	1/4" - 18 NPT	steel	2.10	53.3	0.72	18.3	5/8"

Pneumatic Couplings: L-Series

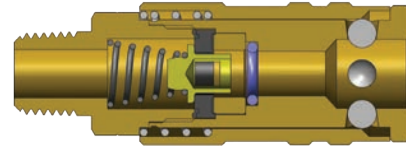

Body Size	L-Series Lincoln Interchange Coupler (Male Threads)							
	Part Detail			Length		Maximum O.D.		Hex Inch
	Part #	Threads	Material	Inch	mm	Inch	mm	
1/4"	2LM2-B	1/4" - 18 NPT	brass	2.62	66.5	0.90	22.9	3/4"

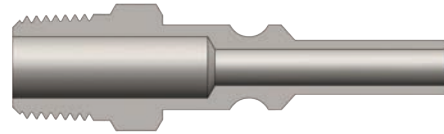
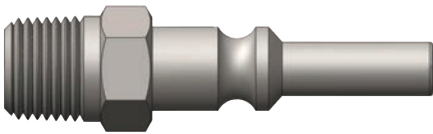

Body Size	L-Series Lincoln Interchange Plug (Male Threads)							
	Part Detail			Length		Maximum O.D.		Hex Inch
	Part #	Threads	Material	Inch	mm	Inch	mm	
1/4"	L2M2	1/4" - 18 NPT	steel	2.25	57.2	0.65	16.5	9/16"

L Series Profile

Body Size	A	B
1/4"	0.28	0.79

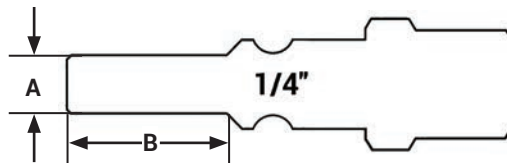

It is important to be safe when installing quick disconnect couplings into a pneumatic circuit. Never install a pneumatic coupling directly into an air tool. Use a piece of hose that is at least 18" long between the tool and the coupling to prevent damage to the coupling. To protect the operator, safety devices such as a safety check valve and safety cable should be installed in case there is a hose or coupling failure.

Pneumatic Couplings: U-Series

Interchange Data

- 2U-Series 6-in-1 (ARO 210, Industrial, Tru-Flate, Lincoln, Italian, and CEJN 320)
- 3U-Series 4-in-1 (ARO 310, Industrial, Tru-Flate, and CEJN 410)
- Parker UC-Series, Hansen Auto-Flo 23, and Coilhose Series UC

Materials

- Machined components are manufactured using solid brass bar stock
- Stainless steel springs, carbon steel balls and retaining rings
- Valve components are machined from solid brass bar stock

Seal Components

- Nitrile pneumatically energized seals are standard, providing a temperature range of **-40°F to 250°F** (-40°C to 121°C)

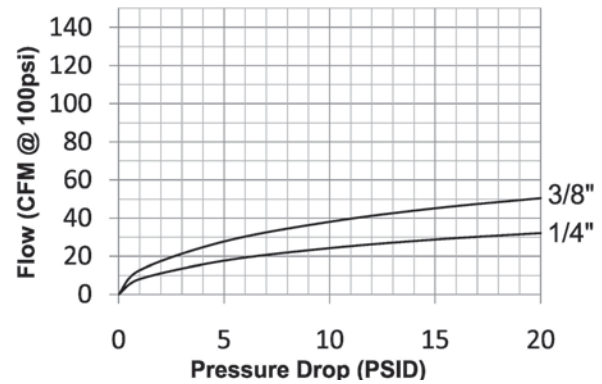

Rated Pressure Chart

Body Size	U-Series Automatic Universal Coupler Connected															
	Coupler/Steel DF Plug				Coupler/Steel CJ Plug				Coupler/Steel J Plug				Coupler/Steel M Plug			
	Max. Working		Burst		Max. Working		Burst		Max. Working		Burst		Max. Working		Burst	
	PSI	Bar	PSI	Bar	PSI	Bar	PSI	Bar	PSI	Bar	PSI	Bar	PSI	Bar	PSI	Bar
1/4"	300	20	2,800	193	300	20	9,500	655	300	20	6,400	441	300	20	4,300	297
3/8"	300	20	2,000	138	300	20	8,000	552	300	20	4,000	276	300	20	2,000	138

Technical Specifications

Body Size	Interchange Standards				Functional Parameters				
	U.S. Military	U.S. Government	International Standards	ANSI/NFPA Standards	Locking Ball Quantity	Air Inclusion	Fluid Loss	Vacuum Rating	Flow ΔP = 15 PSI
1/4"	-	-	-	-	6	N/A	N/A	N/R	37 SCFM
3/8"	-	-	-	-	6	N/A	N/A	N/R	67 SCFM

! Many competitive universal couplings are unable to match the performance capabilities of the Dixon U-Series. Each of the competitive universal couplers only accepts three pneumatic plug styles. Although the universal coupler permits multiple series plugs to mate with one coupler, it is recommended to match like series couplers and plugs. When using a universal coupler, the lower performance rating between the coupler and plug must take precedence.

! Dry air: Some pneumatic applications require the pressurized air to be 'dried' to ensure proper operation of equipment and/or application of product (eg. auto body shops). It is best to match like series couplers and plugs in these applications. If it is necessary to use a universal coupler, lube the seal and valve area regularly to ensure reliable service.

Pneumatic Couplings: U-Series

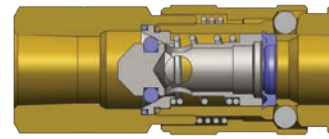

U-Series Automatic Universal Coupler (Female Threads)

Body Size	Part Detail			Length		Maximum O.D.		Hex Inch
	Part #	Threads	Material	Inch	mm	Inch	mm	
	1/4"	2UF2-B	1/4" - 18 NPT	brass	2.32	59.0	0.92	
2UBF2-B		1/4"-19 BSPP	brass	2.32	59.0	0.92	23.4	3/4"
2UF3-B		3/8" - 18 NPT	brass	2.32	59.0	0.92	23.4	3/4"
2UBF3-B		3/8"-19 BSPP	brass	2.32	59.0	0.92	23.4	3/4"
3/8"	3UF3-B	3/8" - 18 NPT	brass	2.54	64.5	1.09	27.7	15/16"
	3UBF3-B	3/8"-19 BSPP	brass	2.54	64.5	1.09	27.7	15/16"

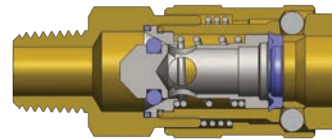

U-Series Automatic Universal Coupler (Male Threads)

Body Size	Part Detail			Length		Maximum O.D.		Hex Inch
	Part #	Threads	Material	Inch	mm	Inch	mm	
	1/4"	2UM2-B	1/4" - 18 NPT	brass	2.44	62.0	0.92	
2UBM2-B		1/4"-19 BSPP	brass	2.44"	62.0	0.92"	23.4	3/4"
2UM3-B		3/8" - 18 NPT	brass	2.44	62.0	0.92	23.4	3/4"
2UBM3-B		3/8"-19 BSPP	brass	2.44	62.0	0.92"	23.4	3/4"
3/8"	3UM3-B	3/8" - 18 NPT	brass	2.64	67.0	1.09	27.7	15/16"
	3UBM3-B	3/8"-19 BSPP	brass	2.64	67.0	1.09"	27.7	15/16"

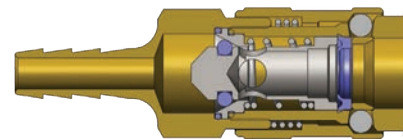
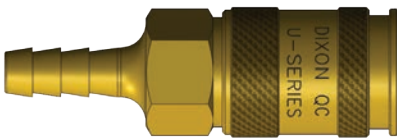

U-Series Automatic Universal Coupler (Standard Hose Barb)

Body Size	Part Detail			Length		Maximum O.D.		Hex Inch
	Part #	Hose I.D.	Material	Inch	mm	Inch	mm	
	1/4"	2US2-B	1/4"	brass	2.64	67.0	0.92	
2US3-B		3/8"	brass	2.76	70.0	0.92	23.4	3/4"
3/8"	3US3-B	3/8"	brass	2.99	76.0	1.09	27.7	15/16"

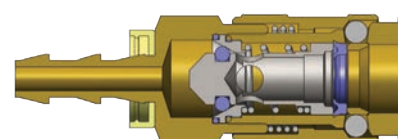
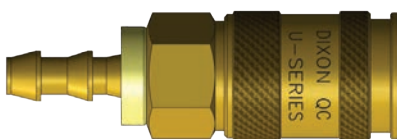

U-Series Automatic Universal Coupler (Push-Loc Barb)

Body Size	Part Detail			Length		Maximum O.D.		Hex Inch
	Part #	Hose I.D.	Material	Inch	mm	Inch	mm	
	1/4"	2UB2-B	1/4"	brass	2.52	64.0	0.92	
2UB3-B		3/8"	brass	2.64	67.0	0.92	23.4	3/4"

Interchange Data

- Bowes Interchange Bayonet Style
- Interchangeable with Bowes 51000-Series, National Series B, Dix-Lock®, MacDonald Quick-Action, and Campbell Single Lock

Seal Components

- Nitrile pneumatically energized seals are standard, providing a temperature range of **-40°F to 250°F** (-40°C to 121°C)

Materials

- Machined components are manufactured using solid steel, brass, or 303 stainless steel bar stock. 316 stainless steel available in some versions upon request
- Stainless steel retaining ring and spring maximize corrosion resistance and extend service life
- Steel componentry is plated using ROHS-compliant trivalent chrome
- Dust cap with steel cable lanyard
- Steel plugs have a cast zinc sleeve
- Steel and brass locking version have an aluminum lock ring while the stainless locking version has a stainless lock ring

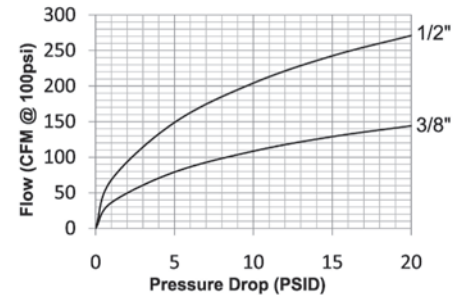

Rated Pressure Chart

Body Size	Dix-Lock N-Series (Connected)											
	Steel Coupler/Plug				Brass Coupler/Plug				303 Stainless Steel Coupler/Plug			
	Max. Working		Burst		Max. Working		Burst		Max. Working		Burst	
	PSI	Bar	PSI	Bar	PSI	Bar	PSI	Bar	PSI	Bar	PSI	Bar
3/8"	500	35	7,000	480	-	-	-	-	-	-	-	-
1/2"	500	35	11,000	755	300	20	8,200	565	500	35	12,600	865

Technical Specifications

Body Size	Interchange Standards				Functional Parameters				
	U.S. Military	U.S. Government	International Standards	ANSI/NFPA Standards	Locking Mechanism	Air Inclusion	Fluid Loss	Vacuum Rating	Flow ΔP = 10 PSI
3/8"	-	-	-	-	latch tabs	N/A	N/A	N/R	108 CFM
1/2"	MIL-C-3486	A-A-50431A	-	-	latch tabs	N/A	N/A	N/R	204 CFM

Available Options

Body Size	Seals	Staked Ferrule Option		
	FKM	1/2" Barb	3/4" Barb	3/4" Stainless Barb
	Prefix	Suffix	Suffix	Suffix
3/8"	F-	-WF	-WF	-WF
1/2"	F-	-WF	-WF	-WF

! It is important to be safe when installing quick disconnect couplings into a pneumatic circuit. Never install a pneumatic coupling directly into an air tool. Use a piece of hose that is at least 18" long between the tool and the coupling to prevent damage to the coupling. To protect the operator, safety devices such as a safety check valve and safety cable should be installed in case there is a hose or coupling failure.

Pneumatic Couplings: Dix-Lock® N-Series

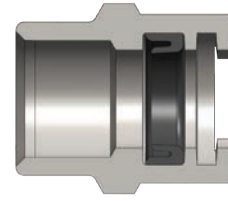
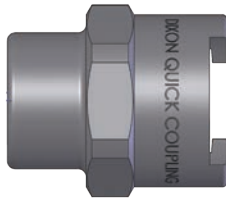

Body Size	Dix-Lock N-Series Coupler (Female Threads)							
	Part Detail			Length		Maximum O.D.		Hex Inch
	Part #	Threads	Material	Inch	mm	Inch	mm	
1/2"	4NBF3	3/8" - 19 BSPP	steel	1.63	41.4	1.54	39.1	1-3/8"
	4NBF4	1/2" - 14 BSPP	steel	1.63	41.4	1.54	39.1	1-3/8"
	4NBF4-B	1/2" - 14 BSPP	brass	1.63	41.4	1.54	39.1	1-3/8"
	4NBF6	3/4" - 14 BSPP	steel	1.63	41.4	1.54	39.1	1-3/8"
	4NBF6-B	3/4" - 14 BSPP	brass	1.63	41.4	1.54	39.1	1-3/8"
	4NBF8	1" - 11 BSPP	steel	1.68	42.6	1.73	43.9	1-1/2"
	4NBF8-B	1" - 11 BSPP	brass	1.68	42.6	1.73	43.9	1-1/2"
	4NF3	3/8" - 18 NPTF	steel	1.63	41.4	1.54	39.1	1-3/8"
	4NF3-B	3/8" - 18 NPTF	brass	1.63	41.4	1.54	39.1	1-3/8"
	4NF4	1/2" - 14 NPTF	steel	1.63	41.4	1.54	39.1	1-3/8"
	4NF4-B	1/2" - 14 NPTF	brass	1.63	41.4	1.54	39.1	1-3/8"
	4NF6	3/4" - 14 NPTF	steel	1.63	41.4	1.54	39.1	1-3/8"
	4NF6-B	3/4" - 14 NPTF	brass	1.63	41.4	1.54	39.1	1-3/8"
	4NF6-S	3/4" - 14 NPTF	303 stainless	1.63	41.4	1.54	39.1	1-3/8"
	4NF6-SS	3/4" - 14 NPTF	316 stainless	1.63	41.4	1.54	39.1	1-3/8"
	4NF8	1" - 11-1/2 NPTF	steel	1.68	42.6	1.73	43.9	1-1/2"
	4NF8-B	1" - 11-1/2 NPTF	brass	1.68	42.6	1.73	43.9	1-1/2"
	4NF8-SS	1" - 11-1/2 NPTF	316 stainless	1.68	42.6	1.73	43.9	1-1/2"

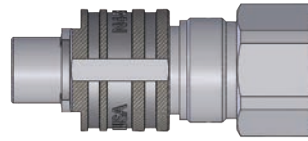
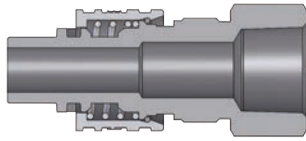

Body Size	Dix-Lock N-Series Plug (Female Threads)							
	Part Detail			Length		Maximum O.D.		Hex Inch
	Part #	Threads	Material	Inch	mm	Inch	mm	
1/2"	N4BF3	3/8" - 19 BSPP	steel	2.92	74.0	1.31	33.3	1-3/16"
	N4BF4	1/2" - 14 BSPP	steel	2.92	74.0	1.31	33.3	1-3/16"
	N4BF4-B	1/2" - 14 BSPP	brass	2.92	74.0	1.31	33.3	1-3/16"
	N4BF6	3/4" - 14 BSPP	steel	3.42	86.7	1.50	38.1	1-3/8"
	N4BF6-B	3/4" - 14 BSPP	brass	3.42	86.7	1.50	38.1	1-3/8"
	N4BF8	1" - 11 BSPP	steel	3.59	91.2	1.79	45.3	1-5/8"
	N4BF8-B	1" - 11 BSPP	brass	3.59	91.2	1.79	45.3	1-5/8"
	N4F3	3/8" - 18 NPTF	steel	2.92	74.0	1.31	33.3	1-3/16"
	N4F3-B	3/8" - 18 NPTF	brass	2.92	74.0	1.31	33.3	1-3/16"
	N4F4	1/2" - 14 NPTF	steel	2.92	74.0	1.31	33.3	1-3/16"
	N4F4-B	1/2" - 14 NPTF	brass	2.92	74.0	1.31	33.3	1-3/16"
	N4F6	3/4" - 14 NPTF	steel	3.42	86.7	1.50	38.1	1-3/8"
	N4F6-B	3/4" - 14 NPTF	brass	3.42	86.7	1.50	38.1	1-3/8"
	N4F6-S	3/4" - 14 NPTF	303 stainless	3.42	86.7	1.50	38.1	1-3/8"
	N4F6-SS	3/4" - 14 NPTF	316 stainless	3.42	86.7	1.50	38.1	1-3/8"
	N4F8	1" - 11-1/2 NPTF	steel	3.59	91.2	1.79	45.3	1-5/8"
N4F8-B	1" - 11-1/2 NPTF	brass	3.59	91.2	1.79	45.3	1-5/8"	
N4F8-SS	1" - 11-1/2 NPTF	316 stainless	3.59	91.2	1.79	45.3	1-5/8"	

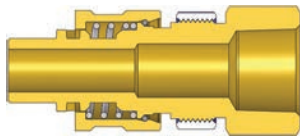

Body Size	Dix-Lock N-Series Plug with Locking Sleeve (Female Threads)							
	Part Detail			Length		Maximum O.D.		Hex Inch
	Part #	Threads	Material	Inch	mm	Inch	mm	
1/2"	N4F4-B-LS	1/2" - 14 NPTF	brass	2.92	74.0	1.31	33.3	1-3/16"
	N4F6-B-LS	3/4" - 14 NPTF	brass	3.42	86.7	1.50	38.1	1-3/8"
	N4F6-LS	3/4" - 14 NPTF	steel	3.42	86.70	1.50	38.10	1-3/8"

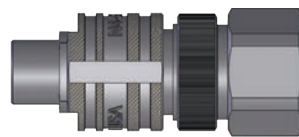
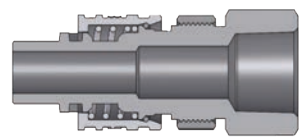

Body Size	Dix-Lock N-Series Plug with Steel Locking Sleeve (Female Threads)							
	Part Detail			Length		Maximum O.D.		Hex Inch
	Part #	Threads	Material	Inch	mm	Inch	mm	
1/2"	N4F6-ZLS	3/4" - 14 NPTF	steel	1.63	41.40	1.54	39.10	1-3/8"

Pneumatic Couplings: Dix-Lock® N-Series

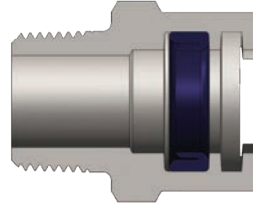
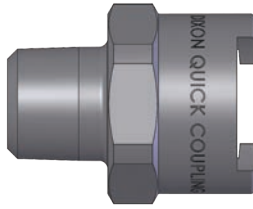

Body Size	Dix-Lock N-Series Coupler (Male Threads)							
	Part Detail			Length		Maximum O.D.		Hex Inch
	Part #	Threads	Material	Inch	mm	Inch	mm	
3/8"	3NBM4	1/2" - 14 BSPT	steel	1.73	43.8	1.1	27.9	1"
	3NM4	1/2" - 14 NPTF	steel	1.8	45.7	1.1	27.9	1"
1/2"	4NBM3	3/8" - 19 BSPT	steel	1.66	42.2	1.5	38.1	1-3/8"
	4NBM4	1/2" - 14 BSPT	steel	1.75	44.5	1.5	38.1	1-3/8"
	4NBM4-B	1/2" - 14 BSPT	brass	1.75	44.5	1.5	38.1	1-3/8"
	4NBM6	3/4" - 14 BSPT	steel	1.85	47	1.5	38.1	1-3/8"
	4NBM6-B	3/4" - 14 BSPT	brass	1.85	47	1.5	38.1	1-3/8"
	4NBM8	1" - 11 BSPT	steel	1.95	49.5	1.5	38.1	1-1/2"
	4NBM8-B	1" - 11 BSPT	brass	1.95	49.5	1.5	38.1	1-1/2"
	4NM3	3/8" - 18 NPTF	steel	1.66	42.2	1.5	38.1	1-3/8"
	4NM3-B	3/8" - 18 NPTF	brass	1.66	42.2	1.5	38.1	1-3/8"
	4NM4	1/2" - 14 NPTF	steel	1.85	47	1.5	38.1	1-3/8"
	4NM4-B	1/2" - 14 NPTF	brass	1.85	47	1.5	38.1	1-3/8"
	4NM6	3/4" - 14 NPTF	steel	1.85	47	1.5	38.1	1-3/8"
	4NM6-B	3/4" - 14 NPTF	brass	1.85	47	1.5	38.1	1-3/8"
	4NM6-S	3/4" - 14 NPTF	303 stainless	1.85	47	1.5	38.1	1-3/8"
	4NM6-SS	3/4" - 14 NPTF	316 stainless	1.85	47	1.5	38.1	1-3/8"
	4NM8	1" - 11-1/2 NPTF	steel	1.95	49.5	1.5	38.1	1-1/2"
	4NM8-B	1" - 11-1/2 NPTF	brass	1.95	49.5	1.5	38.1	1-1/2"
	4NM8-SS	1" - 11-1/2 NPTF	316 stainless	1.95	49.5	1.5	38.1	1-1/2"

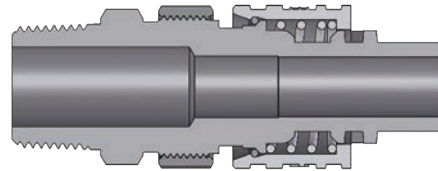
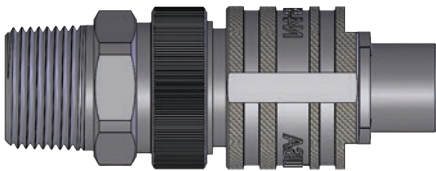

Body Size	Dix-Lock N-Series Interchange Plug with Steel Locking Sleeve (Male Threads)							
	Part Detail			Length		Maximum O.D.		Hex Inch
	Part #	Threads	Material	Inch	mm	Inch	mm	
1/2"	N4M6-ZLS	3/4" - 14 NPTF	steel	3.65	92.70	1.31	33.30	1-3/16"

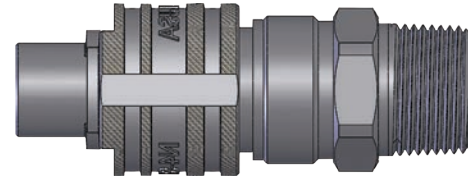
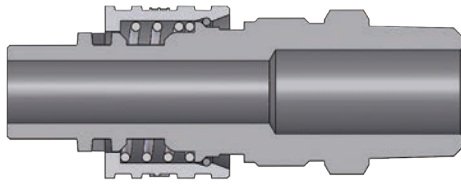

Body Size	Dix-Lock N-Series Plug (Male Threads)								
	Part Detail			Length		Maximum O.D.		Hex Inch	
	Part #	Threads	Material	Inch	mm	Inch	mm		
3/8"	N3BM4	1/2" - 14 BSPT	steel	3.36	85.3	1.13	28.6	1"	
	N3M4	1/2" - 14 NPTF	steel	3.36	85.3	1.13	28.6	1"	
1/2"	N4BM3	3/8" - 19 BSPT	steel	3.46	87.9	1.31	33.3	1-3/16"	
	N4BM4	1/2" - 14 BSPT	steel	3.65	92.7	1.31	33.3	1-3/16"	
	N4BM4-B	1/2" - 14 BSPT	brass	3.65	92.7	1.31	33.3	1-3/16"	
	N4BM6	3/4" - 14 BSPT	steel	3.65	92.7	1.31	33.3	1-3/16"	
	N4BM6-B	3/4" - 14 BSPT	brass	3.64	92.7	1.31	33.3	1-3/16"	
	N4BM8	1" - 11 BSPT	steel	3.89	98.8	1.51	38.4	1-3/8"	
	N4BM8-B	1" - 11 BSPT	brass	3.89	98.8	1.51	38.4	1-3/8"	
	1/2"	N4M3	3/8" - 18 NPTF	steel	3.46	87.9	1.31	33.3	1-3/16"
		N4M3-B	3/8" - 18 NPTF	brass	3.46	87.9	1.31	33.3	1-3/16"
		N4M4	1/2" - 14 NPTF	steel	3.65	92.7	1.31	33.3	1-3/16"
		N4M4-B	1/2" - 14 NPTF	brass	3.65	92.7	1.31	33.3	1-3/16"
		N4M6	3/4" - 14 NPTF	steel	3.65	92.7	1.31	33.3	1-3/16"
		N4M6-B	3/4" - 14 NPTF	brass	3.65	92.7	1.31	33.3	1-3/16"
		N4M6-S	3/4" - 14 NPTF	303 stainless	3.65	92.7	1.31	33.3	1-3/16"
		N4M6-SS	3/4" - 14 NPTF	316 stainless	3.65	92.7	1.31	33.30	1-3/16"
		N4M8	1" - 11-1/2 NPTF	steel	3.89	98.8	1.51	38.4	1-3/8"
N4M8-B		1" - 11-1/2 NPTF	brass	3.89	98.8	1.51	38.4	1-3/8"	
N4M8-SS	1" - 11-1/2 NPTF	316 stainless	3.89	98.8	1.51	38.40	1-3/8"		

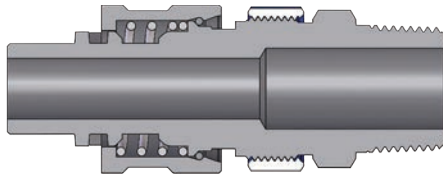

Body Size	Dix-Lock N-Series Plug with Locking Sleeve (Male Threads)							
	Part Detail			Length		Maximum O.D.		Hex Inch
	Part #	Threads	Material	Inch	mm	Inch	mm	
3/8"	N3JM4-ZLS	3/4" - 16 JIC	steel	3.82	97.03	0.99	25.15	5/8"
	N4BM4-LS	1/2" - 14 BSPT	steel	3.65	92.7	1.31	33.3	1-3/16"
	N4BM6-LS	3/4" - 14 BSPT	steel	3.65	92.7	1.31	33.3	1-3/16"
1/2"	N4M4-B-LS	1/2" - 14 NPTF	brass	3.65	92.7	1.31	33.3	1-3/16"
	N4M4-LS	1/2" - 14 NPTF	steel	3.65	92.7	1.31	33.3	1-3/16"
	N4M6-B-LS	3/4" - 14 NPTF	brass	3.65	92.7	1.31	33.3	1-3/16"
	N4M6-LS	3/4" - 14 NPTF	steel	3.65	92.7	1.31	33.3	1-3/16"
	N4M6-S-LS	3/4" - 14 NPTF	303 stainless	3.65	92.7	1.31	33.3	1-3/16"

Pneumatic Couplings: Dix-Lock® N-Series

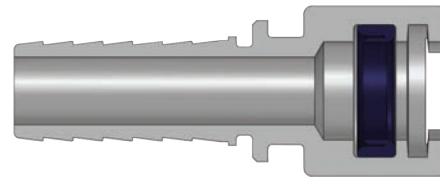
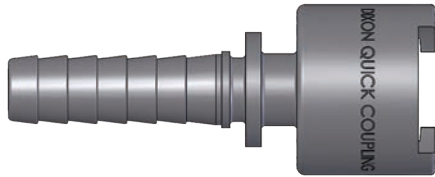

Body Size	Dix-Lock N-Series Coupler (Hose Barb)						
	Part Detail			Length		Maximum O.D.	
	Part #	Hose ID	Material	Inch	mm	Inch	mm
3/8"	3NCS4	1/2"	steel	4.74	120.4	0.99	25.1
	4NS3	3/8"	steel	4.54	115.3	1.4	35.6
	4NS3-B	3/8"	brass	4.54	115.3	1.4	35.6
	4NS4	1/2"	steel	4.95	125.7	1.4	35.6
	4NS4-B	1/2"	brass	4.95	125.7	1.4	35.6
1/2"	4NS6	3/4"	steel	4.95	125.7	1.4	35.6
	4NS6-B	3/4"	brass	4.95	125.7	1.4	35.6
	4NS6-S	3/4"	303 stainless	4.95	125.7	1.4	35.6
	4NS6-SS	3/4"	316 stainless	4.95	125.7	1.4	35.6
	4NS8	1"	steel	5.77	146.4	1.4	35.6
	4NS8-B	1"	brass	5.77	146.4	1.4	35.6
	4NS8-S	1"	303 stainless	5.77	146.4	1.4	35.6
	4NS8-SS	1"	316 stainless	5.77	146.4	1.4	35.6

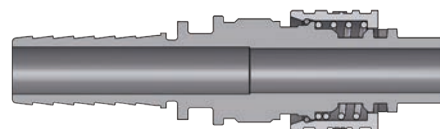

Body Size	Dix-Lock N-Series Plug (Hose Barb)						
	Part Detail			Length		Maximum O.D.	
	Part #	Hose I.D.	Material	Inch	mm	Inch	mm
3/8"	N3CS4	1/2"	steel	3.73	94.8	1.13	28.6
	N4S3	3/8"	steel	4.36	110.7	1.4	35.6
	N4S3-B	3/8"	brass	4.36	110.7	1.4	35.6
	N4S4	1/2"	steel	4.63	117.6	1.4	35.6
	N4S4-B	1/2"	brass	4.63	117.6	1.4	35.6
1/2"	N4S6	3/4"	steel	4.77	121.2	1.4	35.6
	N4S6-B	3/4"	brass	4.77	121.2	1.4	35.6
	N4S6-S	3/4"	303 stainless	4.77	121.2	1.4	35.6
	N4S6-SS	3/4"	316 stainless	4.77	121.2	1.4	35.6
	N4S8	1"	steel	4.77	121.2	1.4	35.6
	N4S8-B	1"	brass	4.77	121.2	1.4	35.6
	N4S8-S	1"	303 stainless	4.77	121.2	1.4	35.6
	N4S8-SS	1"	316 stainless	4.77	121.2	1.4	35.6

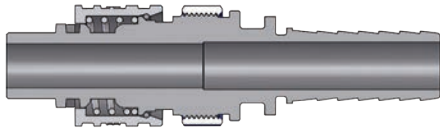

Body Size	Dix-Lock N-Series Plug with Locking Sleeve (Hose Barb)							
	Part Detail			Length		Maximum O.D.		Hex Inch
	Part #	Hose I.D.	Material	Inch	mm	Inch	mm	
1/2"	N4S4-LS	1/2"	steel	4.95	125.7	1.40	35.6	-
	N4S4-B-LS	1/2"	brass	4.95	125.7	1.40	35.6	-
	N4S6-LS	3/4"	steel	4.95	125.7	1.40	35.6	-
	N4S6-B-LS	3/4"	brass	4.95	125.7	1.40	35.6	-
	N4S6-S-LS	3/4"	303 stainless	4.95	125.7	1.40	35.6	-

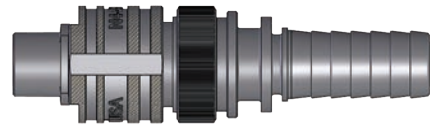
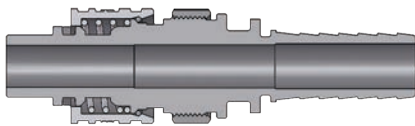

Body Size	Dix-Lock N-Series Interchange Plug with Steel Locking Sleeve (Hose Barb)							
	Part Detail			Length		Maximum O.D.		Hex Inch
	Part #	Threads	Material	Inch	mm	Inch	mm	
1/2"	N4S6-ZLS	3/4" barb	steel	4.77	121.20	1.40	35.60	-

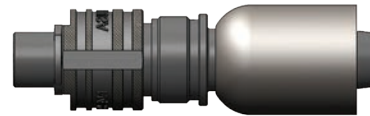
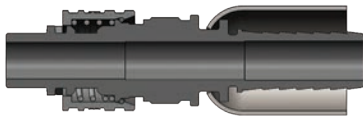

Body Size	Dix-Lock N-Series Plug with Ferrule (Hose Barb)								
	Part Detail			Hose O.D.		Length		Maximum O.D.	
	Part #	Hose I.D.	Material	From	To	Inch	mm	Inch	mm
1/2"	N4S4-WF	1/2" barb	steel	54/64"	1-2/64"	4.95	125.70	1.40	35.60
	N4S6-WF	3/4" barb	steel	1-10/64"	1-22/64"	4.95	125.70	1.40	35.60
	N4S4-B-WF	1/2" barb	brass	54/64"	1-2/64"	4.95	125.70	1.40	35.60
	N4S6-B-WF	3/4" barb	brass	1-10/64"	1-22/64"	4.95	125.70	1.40	35.60
	N4S6-S-WF	3/4" barb	303 stainless	1-10/64"	1-22/64"	4.95	125.70	1.40	35.60

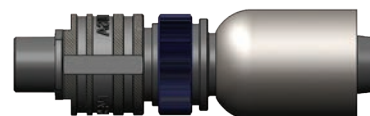
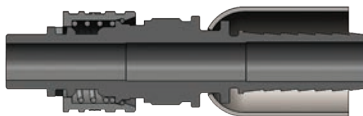

Body Size	Dix-Lock N-Series Plug with Locking Sleeve and Ferrule (Hose Barb)								
	Part Detail			Hose O.D.		Length		Maximum O.D.	
	Part #	Hose I.D.	Material	From	To	Inch	mm	Inch	mm
1/2"	N4S4-B-LS-WF	1/2" barb	brass	54/64"	1-2/64"	4.95	125.70	1.40	35.60
	N4S6-B-LS-WF	3/4" barb	brass	1-10/64"	1-22/64"	4.95	125.70	1.40	35.60
	N4S4-LS-WF	1/2" barb	steel	54/64"	1-2/64"	4.95	125.70	1.40	35.60
	N4S6-LS-WF	3/4" barb	steel	1-10/64"	1-22/64"	4.95	125.70	1.40	35.60

Pneumatic Couplings: Dix-Lock® N-Series

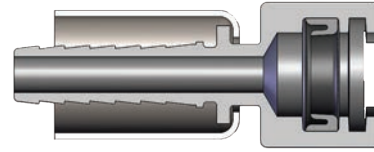
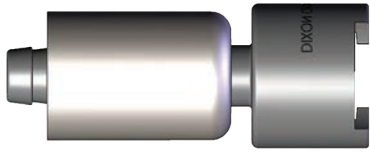

Body Size	Dix-Lock N-Series Coupler with Ferrule (Hose Barb)								
	Part Detail			Hose O.D.		Length		Maximum O.D.	
	Part #	Hose I.D.	Material	From	To	Inch	mm	Inch	mm
1/2"	4NS4-WF	1/2" barb	steel	5/4"	1-2/64"	4.95	125.70	1.40	35.60
	4NS4-B-WF	1/2" barb	brass	5/4"	1-2/64"	4.95	125.70	1.40	35.60
	4NS6-WF	3/4" barb	steel	1-10/64"	1-22/64"	4.95	125.70	1.40	35.60
	4NS6-B-WF	3/4" barb	brass	1-10/64"	1-22/64"	4.95	125.70	1.40	35.60

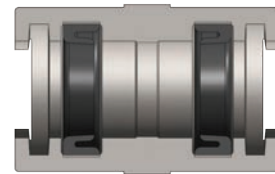
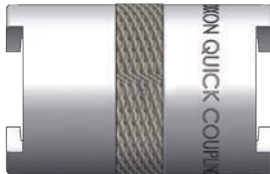

Body Size	Dix-Lock N-Series Gender-Change Union							
	Part Detail			Length		Maximum O.D.		Hex Inch
	Part #	Configuration	Material	Inch	mm	Inch	mm	
1/2"	4N4N	coupler to coupler	steel	3.26	82.8	1.33	33.8	-

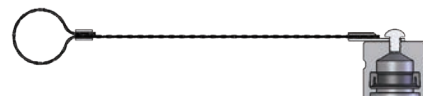
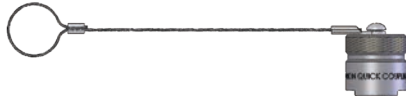

Body Size	Dix-Lock N-Series Protective Plug Cap							
	Part Detail			Length		Maximum O.D.		Hex Inch
	Part #	Cap Lanyard	Material	Inch	mm	Inch	mm	
1/2"	N4DC	steel cable	steel	1.50	38.1	1.33	33.8	-
	N4DC-B	steel cable	brass	1.50	38.1	1.33	33.8	-

Body Size	Dix-Lock N-Series Replacement Seals						
	Part Detail			Seal Kit Contents			
	Part #	Coupler Style	Seal Material				
3/8"	3N-SKIT	all	Nitrile	pneumatically energized seal			
1/2"	4N-SKIT	all	Nitrile				
	F-4N-SKIT	all	FKM				

Interchange Data

- Thor Finger-Lock Interchange
- Interchanges with Thor PHC-Series, National Series A, Dual-Lock, and Campbell Double Lock

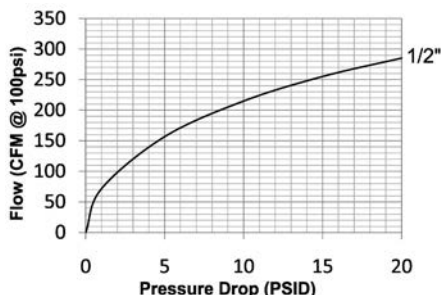

Materials

- Machined components are manufactured using solid steel, brass, or 303 stainless steel bar stock
- Stainless steel retaining ring and spring maximize corrosion resistance and extend service life on the 1-piece sleeve; 2-piece sleeve has a phosphor bronze spring
- Steel componentry is plated using ROHS-compliant trivalent chrome
- Steel couplings have a cast zinc sleeve

Seal Components

- Nitrile seals are standard, providing a temperature range of -40°F to 250°F (-40°C to 121°C)

Rated Pressure Chart

Body Size	Dual-Lock P-Series Thor Interchange (Connected)											
	Steel Coupler/Plug				Brass Coupler/Plug				303 Stainless Steel Coupler/Plug			
	Max. Working		Burst		Max. Working		Burst		Max. Working		Burst	
	PSI	Bar	PSI	Bar	PSI	Bar	PSI	Bar	PSI	Bar	PSI	Bar
1/2"	300	20	2,600	180	300	20	3,500	240	300	20	4,500	310

Technical Specifications

Body Size	Interchange Standards				Functional Parameters					
	U.S. Military	U.S. Government	International Standards	ANSI/NFPA Standards	Locking Mechanism	Air Inclusion	Fluid Loss	Vacuum Rating	Flow ΔP = 15 PSI	
1/2"	-	-	-	-	Latch Fingers	N/A	N/A	N/R	255 CFM	

Available Options

Body Size	Seals	Sleeve Options			Staked Ferrule Option		
	FKM	Flanged	Lock Clip	1/2" Barb	3/4" Barb	3/4" Stainless Barb	
	Prefix	Suffix	Part #	Suffix	Suffix	Suffix	
1/2"	F-	-FS	4P-CLIP	-WF	-WF	-WF	

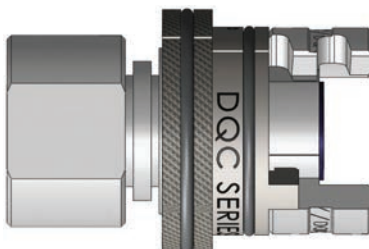

Dual-Lock P Series Coupler with -FS Flanged Sleeve Option

Pneumatic Couplings: Dual-Lock P-Series

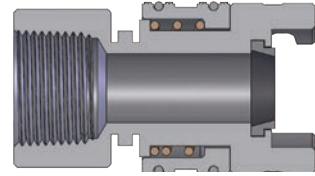
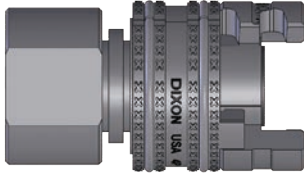

Dual-Lock P-Series Coupler (Female Threads)

Body Size	Dual-Lock P-Series Coupler (Female Threads)							
	Part Detail			Length		Maximum O.D.		Wrench Flats
	Part #	Threads	Material	Inch	mm	Inch	mm	
1/2"	4PF4	1/2" - 14 NPTF	steel	2.75	69.9	1.55	39.4	1-1/4"
	4PF6	3/4" - 14 NPTF	steel	2.75	69.9	1.55	39.4	1-1/4"
	4PF6-B	3/4" - 14 NPTF	brass	2.75	69.9	1.55	39.4	1-1/4"
	4PF6-S	3/4" - 14 NPTF	303 stainless	2.75	69.9	1.55	39.4	1-1/4"

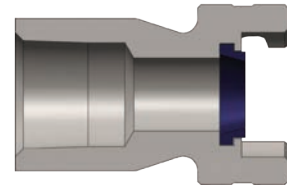
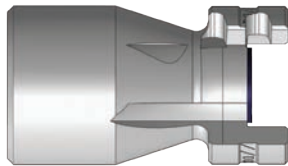

Dual-Lock P-Series Plug (Female Threads)

Body Size	Dual-Lock P-Series Plug (Female Threads)							
	Part Detail			Length		Maximum O.D.		Wrench Flats
	Part #	Threads	Material	Inch	mm	Inch	mm	
1/2"	P4F3	3/8" - 18 NPTF	steel	1.79	45.5	1.55	39.4	7/8"
	P4F4	1/2" - 14 NPTF	steel	2.25	57.2	1.55	39.4	1-5/16"
	P4F4-B	1/2" - 14 NPTF	brass	2.25	57.2	1.55	39.4	1-5/16"
	P4F6	3/4" - 14 NPTF	steel	2.34	59.4	1.55	39.4	1-5/16"
	P4F6-9	3/4" - 14 NPTF	steel/PTFE coat	2.34	59.4	1.55	39.4	1-5/16"
	P4F6-B	3/4" - 14 NPTF	brass	2.34	59.4	1.55	39.4	1-5/16"
	P4F6-S	3/4" - 14 NPTF	303 stainless	2.34	59.4	1.55	39.4	1-5/16"
	P4F8	1" - 11-1/2 NPTF	steel	2.76	70.1	1.55	39.4	1-7/16"
	P4F8-B	1" - 11-1/2 NPTF	brass	2.76	70.1	1.55	39.4	1-7/16"

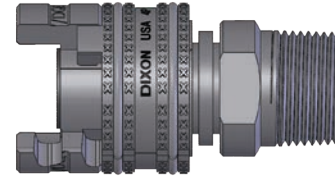
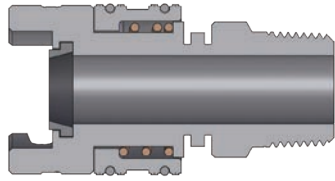

Body Size	Dual-Lock P-Series Coupler (Male Threads)							
	Part Detail			Length		Maximum O.D.		Wrench Flats
	Part #	Threads	Material	Inch	mm	Inch	mm	
1/2"	4PM3	3/8" - 18 NPTF	steel	2.93	74.4	1.55	39.4	7/8"
	4PM4	1/2" - 14 NPTF	steel	2.94	74.7	1.55	39.4	7/8"
	4PM6	3/4" - 14 NPTF	steel	2.98	75.7	1.55	39.4	1-1/16"
	4PM6-9	3/4" - 14 NPTF	steel/PTFE coat	2.98	75.7	1.55	39.4	1-1/16"
	4PM6-S	3/4" - 14 NPTF	303 stainless	2.98	75.7	1.55	39.4	1-1/16"
	4PM8	1" - 11-1/2 NPTF	steel	3.11	79.0	1.55	39.4	1-3/8"

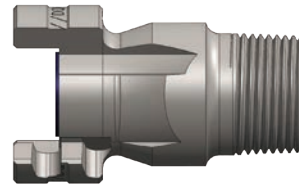
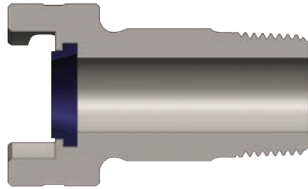

Body Size	Dual-Lock P-Series Plug (Male Threads)							
	Part Detail			Length		Maximum O.D.		Wrench Flats
	Part #	Threads	Material	Inch	mm	Inch	mm	
1/2"	P4M3	3/8" - 18 NPTF	steel	2.00	50.8	1.55	39.4	7/8"
	P4M4	1/2" - 14 NPTF	steel	2.25	57.2	1.55	39.4	15/16"
	P4M4-B	1/2" - 14 NPTF	brass	2.25	57.2	1.55	39.4	15/16"
	P4M6	3/4" - 14 NPTF	steel	2.55	64.8	1.55	39.4	1-1/8"
	P4M6-9	3/4" - 14 NPTF	steel/PTFE coat	2.55	64.8	1.55	39.4	1-1/8"
	P4M6-B	3/4" - 14 NPTF	brass	2.55	64.8	1.55	39.4	1-1/8"
	P4M6-S	3/4" - 14 NPTF	303 stainless	2.55	64.8	1.55	39.4	1-1/8"
	P4M8	1" - 11-1/2 NPTF	steel	3.25	82.6	1.55	39.4	1-3/8"
	P4M8-B	1" - 11-1/2 NPTF	brass	3.25	82.6	1.55	39.4	1-3/8"

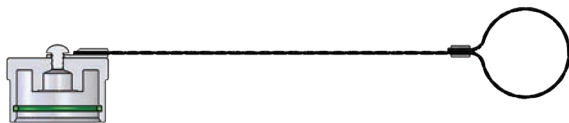

Body Size	Dual-Lock P-Series Cap		
	Part Detail		
	Part #	Cap Lanyard	Material
1/2"	4PDC-A	steel	aluminum

Pneumatic Couplings: Dual-Lock P-Series

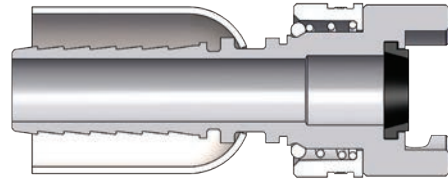
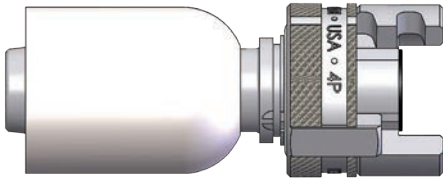

Dual-Lock P-Series Coupler with Ferrule (Hose Barb)

Body Size	Dual-Lock P-Series Coupler with Ferrule (Hose Barb)								
	Part Detail			Hose O.D.		Length		Maximum O.D.	
	Part #	Hose I.D.	Material	From	To	Inch	mm	Inch	mm
1/2"	4PS4-WF	1/2" barb	steel	54/64"	1-2/64"	3.95	100.30	1.55	39.40
	4PS4-B-WF	1/2" barb	brass	54/64"	1-2/64"	3.95	100.30	1.55	39.40
	4PS6-WF	3/4" barb	steel	1-10/64"	1-22/64"	3.95	100.30	1.55	39.40
	4PS6-B-WF	3/4" barb	brass	1-10/64"	1-22/64"	3.95	100.30	1.55	39.40
	4PS6-S-WF	3/4" barb	303 stainless	1-10/64"	1-22/64"	3.95	100.30	1.55	39.40

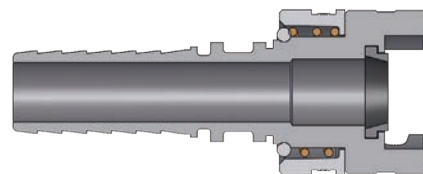

Dual-Lock P-Series Coupler (Hose Barb)

Body Size	Dual-Lock P-Series Coupler (Hose Barb)							
	Part Detail			Length		Maximum O.D.		Hex Inch
	Part #	Hose I.D.	Material	Inch	mm	Inch	mm	
1/2"	4PS3	3/8"	steel	3.53	89.7	1.55	39.4	-
	4PS4	1/2"	steel	3.95	100.3	1.55	39.4	-
	4PS4-B	1/2"	brass	3.95	100.3	1.55	39.4	-
	4PS6	3/4"	steel	3.95	100.3	1.55	39.4	-
	4PS6-9	3/4"	steel/PTFE coat	3.95	100.3	1.55	39.4	-
	4PS6-B	3/4"	brass	3.95	100.3	1.55	39.4	-
	4PS6-S	3/4"	303 stainless	3.95	100.3	1.55	39.4	-
	4PS8	1"	steel	6.06	153.9	1.55	39.4	-
	4PS8-B	1"	brass	6.06	153.9	1.55	39.4	-

Dual-Lock P-Series Replacement Seals

Body Size	Dual-Lock P-Series Replacement Seals			
	Part Detail			Seal Kit Contents
	Part #	Coupler Style	Material	
1/2"	4P-SKIT	all	Nitrile	sealing gasket
	F-4P-SKIT	all	FKM	sealing gasket

Interchange Data

- Japanese Industrial Interchange Pneumatic Coupling
- Nitto Kohki Hi-Cupla 200, Rectus Series 13, and CEJN Series 315

Materials

- Machined components are manufactured using solid steel bar stock
- Stainless steel springs; carbon steel balls and retaining rings
- Steel componentry is plated using chrome-over-nickel plating

Seal Components

- Nitrile seals are standard, providing a temperature range of -40°F to 250°F (-40°C to 121°C)

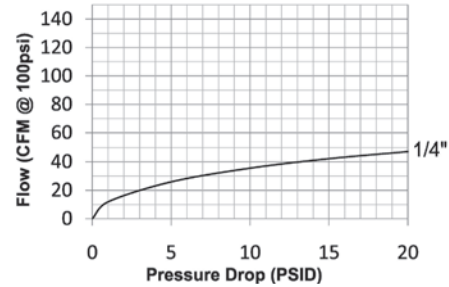

Rated Pressure Chart

Body Size	NK-Series Japanese Industrial Interchange (Connected)			
	Coupler/Plug			
	Maximum Working		Burst	
	PSI	Bar	PSI	Bar
1/4"	300	20	13,500	931

Technical Specifications

Body Size	Interchange Standards				Functional Parameters				
	U.S. Military	U.S. Government	International Standards	ANSI/NFPA Standards	Locking Ball Quantity	Air Inclusion	Fluid Loss	Vacuum Rating	Flow ΔP = 15 PSI
1/4"	-	-	-	-	4	N/A	N/A	N/R	42 CFM

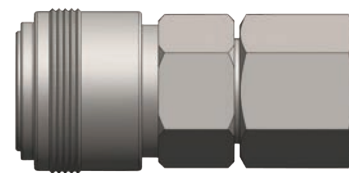
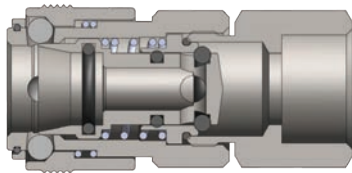

Body Size	NK-Series Japanese Industrial Interchange Coupler (Female Threads)							
	Part Detail			Length		Maximum O.D.		Hex Inch
	Part #	Threads	Material	Inch	mm	Inch	mm	
1/4"	2NKF2	1/4" - 18 NPT	steel	1.97	50.0	1.02	26.0	3/4"
	2NKBF2	1/4" - 19 BSPP	steel	1.97	50.0	1.02	26.0	3/4"

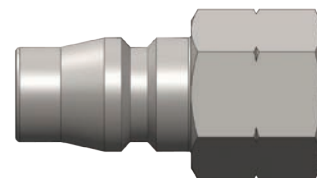
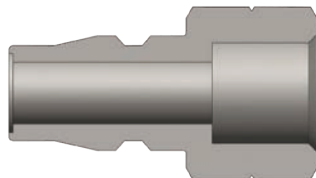

Body Size	NK-Series Japanese Industrial Interchange Plug (Female Threads)							
	Part Detail			Length		Maximum O.D.		Hex Inch
	Part #	Threads	Material	Inch	mm	Inch	mm	
1/4"	NK2F2	1/4" - 18 NPT	steel	1.39	35.2	0.52	13.1	5/8"
	NK2BF2	1/4" - 19 BSPP	steel	1.39	35.2	0.52	13.1	5/8"

Pneumatic Couplings: NK-Series

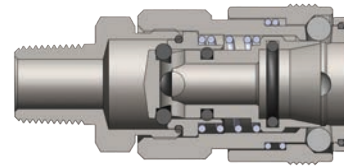
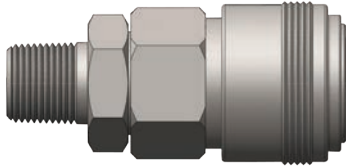

Body Size	NK-Series Japanese Industrial Interchange Coupler (Male Threads)							
	Part Detail			Length		Maximum O.D.		Hex Inch
	Part #	Threads	Material	Inch	mm	Inch	mm	
1/4"	2NKM2	1/4" - 18 NPT	steel	2.12	54.0	1.02	26.0	3/4"
	2NKBM2	1/4" - 19 BSPT	steel	2.12	54.0	1.02	26.0	3/4"

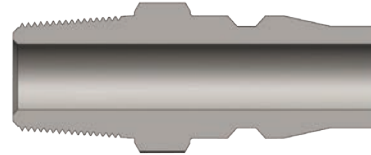
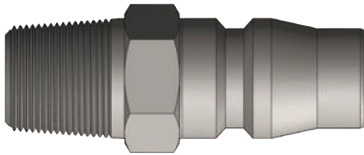

Body Size	NK-Series Japanese Industrial Interchange Plug (Male Threads)							
	Part Detail			Length		Maximum O.D.		Hex Inch
	Part #	Threads	Material	Inch	mm	Inch	mm	
1/4"	NK2M2	1/4" - 18 NPT	steel	1.54	39.2	0.52	13.1	5/8"
	NK2BM2	1/4" - 19 BSPT	steel	1.54	39.2	0.52	13.1	5/8"

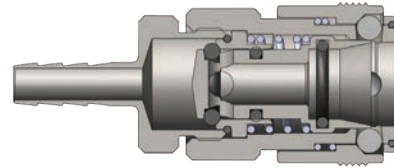
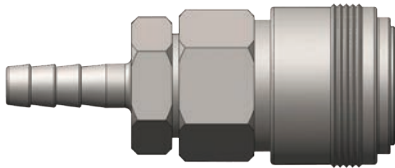

Body Size	NK-Series Japanese Industrial Interchange Coupler (Hose Barb)							
	Part Detail			Length		Maximum O.D.		Hex Inch
	Part #	Hose I.D.	Material	Inch	mm	Inch	mm	
1/4"	2NKS2	1/4"	steel	2.40	61.0	1.02	26.0	3/4"

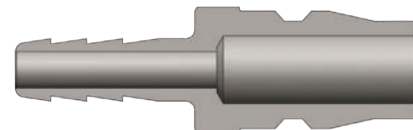
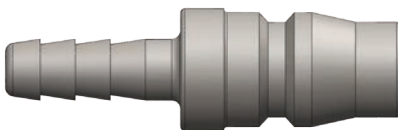

Body Size	NK-Series Japanese Industrial Interchange Plug (Hose Barb)							
	Part Detail			Length		Maximum O.D.		Hex Inch
	Part #	Hose I.D.	Material	Inch	mm	Inch	mm	
1/4"	NK2S2	1/4"	steel	1.78	45.2	0.44	11.3	-

Interchange Data

- Rectus 21KA, CEJN Series 223

Materials

- Machined components are manufactured using solid brass bar stock
- Stainless steel springs; carbon steel balls and retaining rings
- Machined components are plated with chrome-over-nickel plating

Seal Components

- Nitrile seals are standard, providing a temperature range of -40°F to 250°F (-40°C to 121°C)

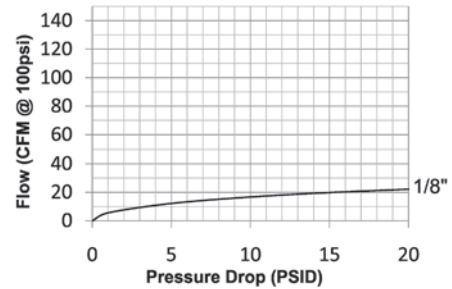

Rated Pressure Chart

Body Size	BR-Series 21-Series Interchange (Connected)			
	Coupler/Plug			
	Maximum Working		Burst	
	PSI	Bar	PSI	Bar
1/8"	300	20	7,000	483

Technical Specifications

Body Size	Interchange Standards				Functional Parameters				
	U.S. Military	U.S. Government	International Standards	ANSI/NFPA Standards	Locking Ball Quantity	Air Inclusion	Fluid Loss	Vacuum Rating	Flow ΔP = 15 PSI
1/4"	-	-	-	-	6	N/A	N/A	N/R	20 CFM

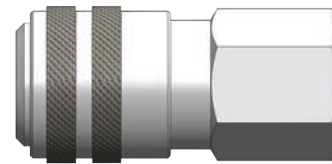
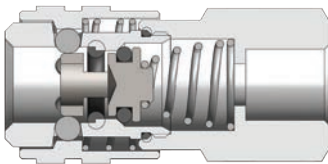

Body Size	BR-Series 21-Series Interchange Coupler (Female Threads)							
	Part Detail			Length		Maximum O.D.		Hex Inch
	Part #	Threads	Material	Inch	mm	Inch	mm	
1/8"	1BRF1-B-7	1/8" - 27 NPT	brass	1.55	39.4	0.65	16.5	9/16"
	1BRBF1-B-7	1/8" - 28 BSPP	brass	1.55	39.4	0.65	16.5	9/16"
	1BRF2-B-7	1/4" - 18 NPT	brass	1.77	45.0	0.72	18.3	5/8"
	1BRBF2-B-7	1/4" - 19 BSPP	brass	1.77	45.0	0.72	18.3	5/8"

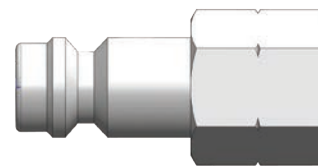
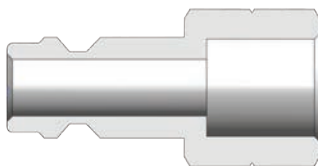

Body Size	BR-Series 21-Series Interchange Plug (Female Threads)							
	Part Detail			Length		Maximum O.D.		Hex Inch
	Part #	Threads	Material	Inch	mm	Inch	mm	
1/8"	BR1F1-B-E-7	1/8" - 27 NPT	brass	1.14	29.0	0.65	16.5	9/16"
	BR1BF1-B-E-7	1/8" - 28 BSPP	brass	1.14	29.0	0.65	16.5	9/16"
	BR1F2-B-E-7	1/4" - 18 NPT	brass	1.33	33.8	0.72	18.3	5/8"
	BR1BF2-B-E-7	1/4" - 19 BSPP	brass	1.33	33.8	0.72	18.3	5/8"

Pneumatic Couplings: BR-Series

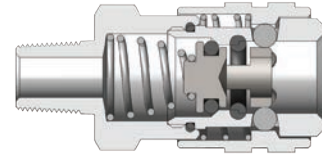
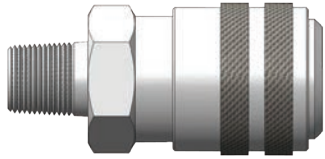

Body Size	BR-Series 21-Series Interchange Coupler (Male Threads)							
	Part Detail			Length		Maximum O.D.		Hex Inch
	Part #	Threads	Material	Inch	mm	Inch	mm	
1/8"	1BRM1-B-7	1/8" - 27 NPT	brass	1.49	37.8	0.65	16.5	9/16"
	1BRGM1-B-7	1/8" - 28 BSPP	brass	1.49	37.8	0.65	16.5	9/16"
	1BRM2-B-7	1/4" - 18 NPT	brass	1.61	40.9	0.72	18.3	5/8"
	1BRGM2-B-7	1/4" - 19 BSPP	brass	1.61	40.9	0.72	18.3	5/8"

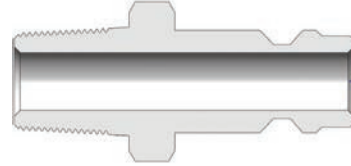
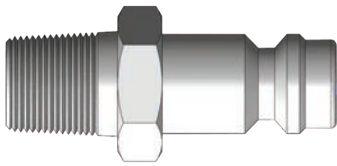

Body Size	BR-Series 21-Series Interchange Plug (Male Threads)							
	Part Detail			Length		Maximum O.D.		Hex Inch
	Part #	Threads	Material	Inch	mm	Inch	mm	
1/8"	BR1M1-B-E-7	1/8" - 27 NPT	brass	1.06	26.9	0.65	16.5	9/16"
	BR1GM1-B-E-7	1/8" - 28 BSPP	brass	1.06	26.9	0.65	16.5	9/16"
	BR1M2-B-E-7	1/4" - 18 NPT	brass	1.20	30.5	0.72	18.3	5/8"
	BR1GM2-B-E-7	1/4" - 19 BSPP	brass	1.20	30.5	0.72	18.3	5/8"

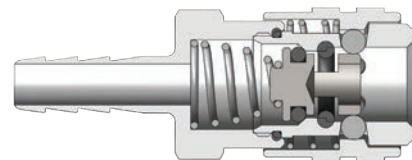
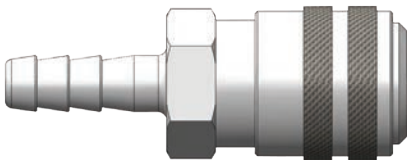

Body Size	BR-Series 21-Series Interchange Coupler (Hose Barb)							
	Part Detail			Length		Maximum O.D.		Hex Inch
	Part #	Hose I.D.	Material	Inch	mm	Inch	mm	
1/8"	1BRS1.25-B-7	4mm	brass	1.26	32.0	0.35	8.9	9/16"
	1BRS1.86-B-7	6mm	brass	1.26	32.0	0.35	8.9	9/16"
	1BRS2.83-B-7	9mm	brass	1.26	32.0	0.35	8.9	9/16"

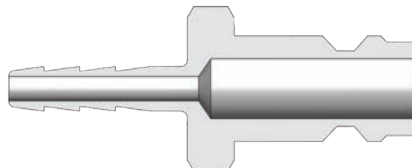
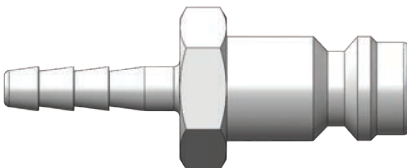

Body Size	BR-Series 21-Series Interchange Plug (Hose Barb)							
	Part Detail			Length		Maximum O.D.		Hex Inch
	Part #	Hose I.D.	Material	Inch	mm	Inch	mm	
1/8"	BR1S1.25-B-E-7	4mm	brass	1.26	32.0	0.35	8.9	9/16"
	BR1S1.86-B-E-7	6mm	brass	1.26	32.0	0.35	8.9	9/16"
	BR1S2.83-B-E-7	9mm	brass	1.26	32.0	0.35	8.9	9/16"

Interchange Data

- Dixon Quick Coupling proprietary astronautics compact series

Materials

- Machined components are manufactured using solid steel or brass bar stock
- Stainless steel balls, retaining rings, and springs maximize corrosion resistance and extend service life
- Steel componentry is plated using ROHS-compliant trivalent chrome
- Couplers are constructed of brass with steel valve as standard

Seal Components

- Nitrile seals are standard, providing a temperature range of -40°F to 250°F (-40°C to 121°C)

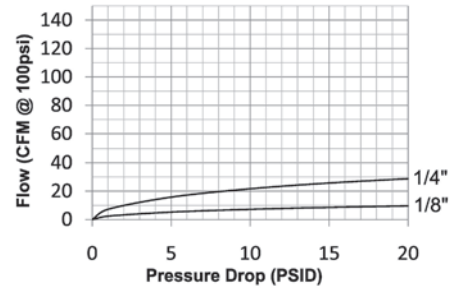

Rated Pressure Chart

Body Size	A-Series Compact (Connected)							
	Brass Coupler/Steel Plug				Brass Coupler/Plug			
	Maximum Working		Burst		Maximum Working		Burst	
	PSI	Bar	PSI	Bar	PSI	Bar	PSI	Bar
1/8"	1,000	70	18,500	1,275	500	35	15,500	1,070
1/4"	1,000	70	8,000	550	500	35	6,500	450

Technical Specifications

Body Size	Interchange Standards				Functional Parameters				
	U.S. Military	U.S. Government	International Standards	ANSI/NFPA Standards	Locking Ball Quantity	Air Inclusion	Fluid Loss	Vacuum Rating	Flow ΔP = 15 PSI
1/8"	-	-	-	-	3	N/A	N/A	N/R	8.6 CFM
1/4"	-	-	-	-	3	N/A	N/A	N/R	26 CFM

Available Options

Body Size	Seal Options		Valve Options			Sleeve Options		Treatments
	FKM	EPDM	Unvalved	Brass	303 SS	Flanged	Sleeve-Lock	Oxy-Clean
	Pre	Pre	Suf	Suf	Suf	Suf	Suf	Suf
1/8"	N/A	N/A	-E	-BV	-SV	N/A	-LS	-C1
1/4"	F-	P-	-E	N/A	N/A	N/A	-LS	-C1

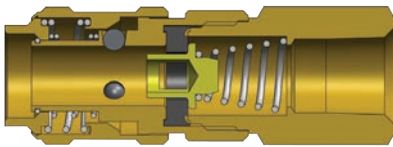

A-Series Compact Coupler (Female Threads)

Body Size	Part Detail							
	Part #	Threads	Material	Length		Maximum O.D.		Hex Inch
				Inch	mm	Inch	mm	
1/8"	1AF1-B	1/8" - 27 NPTF	brass	1.68	42.7	0.64	16.3	1/2"
1/4"	2AF1-B	1/8" - 27 NPTF	brass	2.41	61.2	0.77	19.6	1/2"
	2AF2-B	1/4" - 18 NPTF	brass	2.70	68.6	0.77	19.6	11/16"

Pneumatic Couplings: A-Series

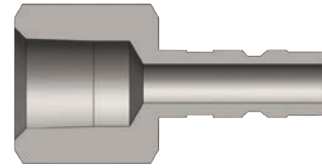
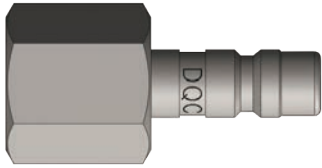

A-Series Compact Plug (Female Threads)

Body Size	A-Series Compact Plug (Female Threads)							
	Part Detail			Length		Maximum O.D.		Hex Inch
	Part #	Threads	Material	Inch	mm	Inch	mm	
1/8"	A1F1-B	1/8" - 27 NPTF	brass	1.26	32.0	0.58	14.7	1/2"
	A2F1-B	1/8" - 27 NPTF	brass	1.34	34.0	0.65	16.5	9/16"
1/4"	A2F2	1/4" - 18 NPTF	steel	1.56	39.6	0.79	20.1	11/16"
	A2F2-B	1/4" - 18 NPTF	brass	1.56	39.6	0.79	20.1	11/16"

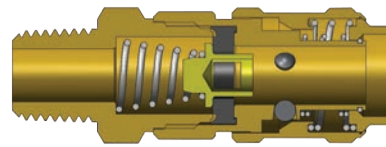
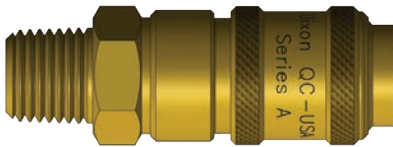

A-Series Compact Coupler (Male Threads)

Body Size	A-Series Compact Coupler (Male Threads)							
	Part Detail			Length		Maximum O.D.		Hex Inch
	Part #	Threads	Material	Inch	mm	Inch	mm	
1/8"	1AM1-B	1/8" - 27 NPTF	brass	1.75	44.5	0.64	16.3	1/2"
1/4"	2AM1-B	1/8" - 27 NPTF	brass	2.12	53.8	0.77	19.6	11/16"
	2AM2-B	1/4" - 18 NPTF	brass	2.23	56.6	0.77	19.6	11/16"

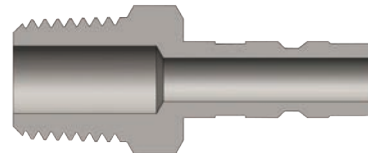

A-Series Compact Plug (Male Threads)

Body Size	A-Series Compact Plug (Male Threads)							
	Part Detail			Length		Maximum O.D.		Hex Inch
	Part #	Threads	Material	Inch	mm	Inch	mm	
1/8"	A1M1-B	1/8" - 27 NPTF	brass	1.30	33.0	0.51	13.0	7/16"
1/4"	A2M2	1/4" - 18 NPTF	steel	1.59	40.4	0.65	16.5	9/16"
	A2M2-B	1/4" - 18 NPTF	brass	1.59	40.4	0.65	16.5	9/16"

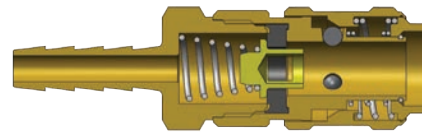
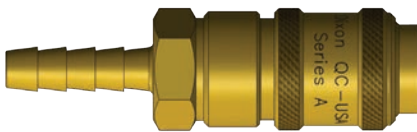

A-Series Compact Coupler (Hose Barb)

Body Size	A-Series Compact Coupler (Hose Barb)							
	Part Detail			Length		Maximum O.D.		Hex Inch
	Part #	Hose I.D.	Material	Inch	mm	Inch	mm	
1/8"	1AS1-B	1/8"	brass	1.98	50.3	0.64	16.3	1/2"
1/4"	2AS2-B	1/4"	brass	2.70	68.6	0.77	19.6	11/16"

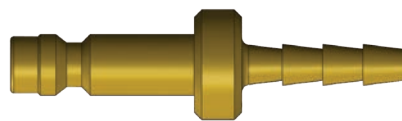
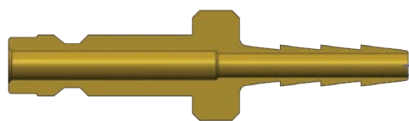

Body Size	A-Series Compact Plug (Hose Barb)							
	Part Detail			Length		Maximum O.D.		Hex Inch
	Part #	Hose I.D.	Material	Inch	mm	Inch	mm	
1/8"	A1S1-B	1/8"	brass	1.50	38.1	0.44	11.2	-
1/4"	A2S2	1/4"	steel	1.99	50.5	1.01	25.7	-

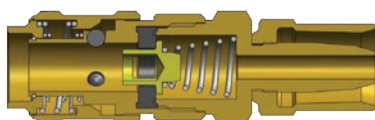

Body Size	A-Series Compact Coupler (Reusable Barb)							
	Part Detail			Length		Maximum O.D.		Hex Inch
	Part #	Hose I.D. x O.D.	Material	Inch	mm	Inch	mm	
1/4"	2AE2-B	1/4" x 1/2"	brass	2.62	66.5	0.77	19.6	11/16"



Body Size	A-Series Compact Plug (Reusable Barb)							
	Part Detail			Length		Maximum O.D.		Hex Inch
	Part #	Hose I.D. x O.D.	Material	Inch	mm	Inch	mm	
1/4"	A2E2	1/4" x 1/2"	steel	1.97	50.0	0.68	17.3	9/16"
	A2E2-B	1/4" x 1/2"	brass	1.97	50.0	0.68	17.3	9/16"

A Series Profiles

Body Size	A	B
1/8"	0.22	0.11
1/4"	0.32	0.20

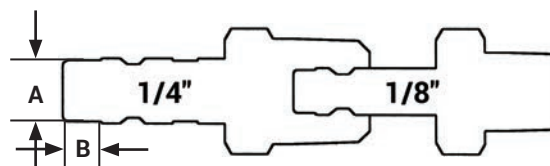

! Operating pressure for couplings utilizing hose barb end connections may be dramatically reduced to that of the hose rating and/or hose end connection combination. Consult hose manufacturer's catalog for hose end connection ratings. If in doubt, test under controlled conditions for suitability to application. Dixon Quick Coupling cannot assume liability for misapplication of production resulting in equipment down-time, lost production, and/or personal injury including death.

Interchange Data

- Hansen FS-Series

Materials

- Machined components are manufactured using solid brass bar stock
- Stainless steel springs and roll-pins maximize corrosion resistance and extend service life

Seal Components

- Nitrile seals are standard, providing a temperature range of **-40°F to 250°F (-40°C to 121°C)**

Features

- Does not prevent backflow
- High flow design results in maximum flow with minimal pressure drop
- Automatically and instantly protects the operator against hose whip in the event of a damaged hose or coupling
- In the event of a hose rupture or coupling failure, the valve will automatically reset after the problem is fixed
- SCV-Series is available in a large selection of sizes ranging from 1/4" to 3", NPTF (BSPP/BSPT threads on request)
- Valve operation is fully compliant with OSHA Safety Regulation 1926.302(b)(7), as shown on page 14

 Not recommended for applications requiring 100% of the available air supply. These applications include, but are not limited to, sand blast equipment, pile driving rigs, and expansion joint blow down pipes. It is recommended to install auxiliary safety devices, including safety cables, to ensure optimum safety for the operator in the event of a coupling failure or hose rupture.

Use

- Safety check valves operate by using the pressure differential across the valve to operate the valve and spring assembly. The pressure differential is directly related to the flow of air (SCFM) through the valve.
- When the pressure differential is within the operating limits - below the cutoff flow - of the unit, the force on the valve exerted by the spring is greater than that caused by the pressure differential (see "open position" graphic on next page). The valve remains open and normal operation continues.
- When the pressure differential is above the cutoff limit, the force on the valve exerted by the pressure differential is greater than the force exerted by the spring, and the valve closes (see "closed position" graphic on next page).
- After the repair is made, normal operation is automatically enabled when pressure across the valve equalizes through the bleeder hole.
- The valve spring size can be specified by determining the air flow during normal operation and by estimating the air flow if a failure or rupture occurs.

Technical Specifications

Performance Specifications	Maximum Operating Pressure - Bar (PSI)	Minimum Burst Pressure - Bar (PSI)	Air Flow ¹ 30.5m (100')
1/4"	24 (350)	138 (2,000)	17 SCFM
3/8"	24 (350)	138 (2,000)	41 SCFM
1/2"	24 (350)	138 (2,000)	77 SCFM
3/4"	24 (350)	138 (2,000)	178 SCFM
1"	24 (350)	138 (2,000)	340 SCFM
1-1/4"	24 (350)	138 (2,000)	620 SCFM
1-1/2"	24 (350)	138 (2,000)	940 SCFM
2"	24 (350)	138 (2,000)	1,760 SCFM
2-1/2"	24 (350)	138 (1,500)	2,800 SCFM
3"	24 (350)	138 (1,200)	4,200 SCFM

¹Air flow rating is based upon calculated values using unobstructed air flow for the applicable hose size.

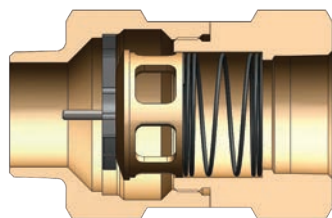

Open

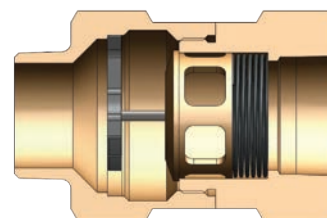

Closed

Body Size	SCV-Series Excessive Flow Sensor (Male to Female Threads)			
	Part Detail			Cutoff Flow - SCFM ¹ (90 PSI Inlet Pressure)
	Part #	Threads	Material	
1/4"	SCVL2	1/4" - 18 NPTF	brass	23-29
3/8"	SCVL3	3/8" - 18 NPTF	brass	30-36
	SCVM3	3/8" - 18 NPTF	brass	39-47
1/2"	SCVS3	3/8" - 18 NPTF	brass	52-65
	SCVM4	1/2" - 14 NPTF	brass	70-78
3/4"	SCVS4	1/2" - 14 NPTF	brass	80-96
	SCVL6	3/4" - 14 NPTF	brass	72-88
	SCVM6	3/4" - 14 NPTF	brass	92-108
	SCVR6	3/4" - 14 NPTF	brass	112-128
	SCVJ6	3/4" - 14 NPTF	brass	132-148
	SCVS6	3/4" - 14 NPTF	brass	160-180
1"	SCVH6	3/4" - 14 NPTF	brass	180-200
	SCVL8	1" - 11-1/2 NPTF	brass	165-195
	SCVM8	1" - 11-1/2 NPTF	brass	220-260
	SCVS8	1" - 11-1/2 NPTF	brass	280-320
1-1/4"	SCVH8	1" - 11-1/2 NPTF	brass	310-340
	SCVL10	1-1/4" - 11-1/2 NPTF	brass	260-290
	SCVM10	1-1/4" - 11-1/2 NPTF	brass	300-340
	SCVS10	1-1/4" - 11-1/2 NPTF	brass	440-500
1-1/2"	SCVH10	1-1/4" - 11-1/2 NPTF	brass	570-630
	SCVL12	1-1/2" - 11-1/2 NPTF	brass	300-360
	SCVM12	1-1/2" - 11-1/2 NPTF	brass	470-530
	SCVX12	1-1/2" - 11-1/2 NPTF	brass	564-602
2"	SCVS12	1-1/2" - 11-1/2 NPTF	brass	640-720
	SCVH12	1-1/2" - 11-1/2 NPTF	brass	750-830
	SCVL16	2" - 11-1/2 NPTF	brass	510-590
	SCVM16	2" - 11-1/2 NPTF	brass	725-825
3"	SCVS16	2" - 11-1/2 NPTF	brass	900-1050
	SCVH16	2" - 11-1/2 NPTF	brass	1100-1200
	SCVL24	3" - 11-1/2 NPTF	brass	1200-1400
3"	SCVS24	3" - 11-1/2 NPTF	brass	2400-2700
	SCVH24	3" - 11-1/2 NPTF	brass	2850-3050

¹Contact Dixon for cutoff flow values at other inlet pressures.

Hydraulic Couplings: H-Series

Interchange Data

- Interchangeable to ISO7241 Series B
- Parker 60-Series, Snap-Tite 72-Series, Hansen HK-Series, Faster Series 'HNV' Eaton/Aeroquip FD45, Stucchi Series IRB/IRBO/IRBX

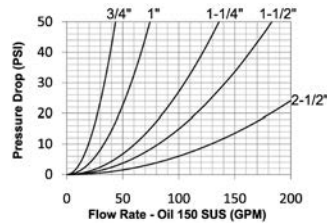
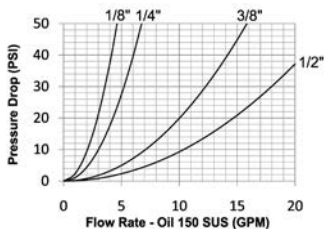

Materials

- Machined components are manufactured using solid steel, brass, 303 stainless steel, or 316 stainless steel bar stock
- Stainless steel balls, retaining rings, and springs maximize corrosion resistance and extend service life
- Steel componentry is plated using ROHS-compliant trivalent chrome
- Steel coupler sleeves are hardened to resist deformation and maximize service life
- Steel plugs are hardened to provide heavy-duty performance and resist brinelling

Seal Components

- Nitrile seals are standard, providing a temperature range of -40°F to 250°F (-40°C to 121°C)
- 1/8" to 1" couplers have a redundant O-ring sealing system with PTFE backup ring. 1-1/4" to 2-1/2" have a Hytrel backup ring
- 1/4" to 1" valve seals are crimped in place to maintain integrity during excessive flow conditions and pressurized connection

Rated Pressure Chart

Body Size	H-Series ISO-B Interchange (Connected)															
	Steel Coupler/Plug				Brass Coupler/Plug				303 Stainless Coupler/Plug				316 Stainless Coupler/Plug			
	Max. Working		Burst		Max. Working		Burst		Max. Working		Burst		Max. Working		Burst	
	PSI	Bar	PSI	Bar	PSI	Bar	PSI	Bar	PSI	Bar	PSI	Bar	PSI	Bar	PSI	Bar
1/8"	4,000	275	14,500	1,000	3,000	200	16,500	1,100	3,625	250	29,500	2,000	3,625	250	29,500	2,000
1/4"	5,000	345	22,500	1,550	3,000	200	15,000	1,000	3,625	250	31,500	2,150	3,625	250	33,000	2,200
3/8"	4,000	275	16,500	1,150	3,000	200	12,000	800	3,625	250	26,500	1,800	3,625	250	28,000	1,900
1/2"	4,000	275	16,000	1,100	2,500	175	11,500	750	3,625	250	27,500	1,900	3,625	250	22,000	1,500
3/4"	4,000	275	16,500	1,150	2,000	138	12,000	800	3,000	200	16,000	1,100	3,000	200	21,500	1,450
1"	4,000	275	16,000	1,100	1,500	100	8,500	600	2,000	138	15,000	1,000	2,000	138	15,000	1,000
1-1/4"	2,500	170	10,000	700	1,000	70	6,500	450	2,000	138	10,000	700	1,000	70	8,500	580
1-1/2"	2,500	170	12,500	850	1,000	70	6,500	450	1,500	100	8,500	580	1,000	70	7,000	480
2-1/2"	1,500	100	6,000	400	700	50	5,500	380	1,000	70	6,500	450	900	62	6,000	400

Technical Specifications

Body Size	Interchange Standards				Functional Parameters				
	U.S. Military	U.S. Government	International Standards	ANSI/NFPA Standards	Locking Ball Quantity	Air Inclusion	Fluid Loss	Vacuum Inch HG	Flow ΔP = 22 PSI
1/8"	-	-	ISO7241 B	-	8	0.6cc	0.3cc	27.4	3.1 GPM
1/4"	-	-	ISO7241 B	-	8	1.1cc	0.9cc	27.4	4.5 GPM
3/8"	-	-	ISO7241 B	-	9	2.6cc	1.8cc	27.4	12 GPM
1/2"	-	-	ISO7241 B	-	9	3.8cc	2.9cc	27.4	18 GPM
3/4"	-	-	ISO7241 B	-	12	10.8cc	9.7cc	27.4	29 GPM
1"	-	-	ISO7241 B	-	12	15.9cc	15.3cc	27.4	50 GPM
1-1/4"	-	-	ISO7241 B	-	12	30.0cc	45.0cc	N/R	90 GPM
1-1/2"	-	-	ISO7241 B	-	12	60.0cc	75.0cc	N/R	120 GPM
2-1/2"	-	-	ISO7241 B	-	15	N/A	N/A	N/R	195 GPM

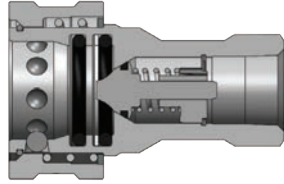

Body Size	H-Series ISO-B Interchange Coupler (Female Threads)							
	Part Detail			Length		Maximum O.D.		Hex Inch
	Part #	Threads	Material	Inch	mm	Inch	mm	
1/8"	1HF1	1/8" - 27 NPTF	steel	1.90	48.3	0.93	23.6	9/16"
	1HF1-B	1/8" - 27 NPTF	brass	1.90	48.3	0.93	23.6	9/16"
	1HF1-S	1/8" - 27 NPTF	303 stainless	1.90	48.3	0.93	23.6	9/16"
	1HF1-SS	1/8" - 27 NPTF	316 stainless	1.90	48.3	0.93	23.6	9/16"
	1HOF2	7/16" - 20 ORB	steel	1.90	48.3	0.93	23.6	9/16"
1/4"	2HF2	1/4" - 18 NPTF	steel	2.26	57.4	1.12	28.4	7/8"
	2HF2-B	1/4" - 18 NPTF	brass	2.26	57.4	1.12	28.4	7/8"
	2HF2-S	1/4" - 18 NPTF	303 stainless	2.26	57.4	1.12	28.4	7/8"
	2HF2-SS	1/4" - 18 NPTF	316 stainless	2.26	57.4	1.12	28.4	3/4"
	2HBF2	1/4" - 19 BSPP	steel	2.26	57.4	1.12	28.4	7/8"
	2HBF2-B	1/4" - 19 BSPP	brass	2.26	57.4	1.12	28.4	7/8"
	2HBF2-S	1/4" - 19 BSPP	303 stainless	2.26	57.4	1.12	28.4	7/8"
	2HBF2-SS	1/4" - 19 BSPP	316 stainless	2.26	57.4	1.12	28.4	3/4"
	2HOF3	9/16" - 18 ORB	steel	2.29	58.2	1.12	28.4	13/16"
3/8"	3HF3	3/8" - 18 NPTF	steel	2.51	63.8	1.42	36.1	1-1/16"
	3HF3-B	3/8" - 18 NPTF	brass	2.51	63.8	1.42	36.1	1-1/16"
	3HF3-S	3/8" - 18 NPTF	303 stainless	2.51	63.8	1.42	36.1	1-1/16"
	3HF3-SS	3/8" - 18 NPTF	316 stainless	2.51	63.8	1.42	36.1	7/8"
	3HBF3	3/8" - 19 BSPP	steel	2.51	63.8	1.42	36.1	1-1/16"
	3HBF3-B	3/8" - 19 BSPP	brass	2.51	63.8	1.42	36.1	1-1/16"
	3HBF3-S	3/8" - 19 BSPP	303 stainless	2.51	63.8	1.42	36.1	1-1/16"
	3HBF3-SS	3/8" - 19 BSPP	316 stainless	2.51	63.8	1.42	36.1	7/8"
	3HOF4	3/4" - 16 ORB	steel	2.62	66.5	1.42	36.1	1"
1/2"	4HF4	1/2" - 14 NPTF	steel	2.86	72.6	1.86	47.2	1-5/16"
	4HF4-B	1/2" - 14 NPTF	brass	2.86	72.6	1.86	47.2	1-5/16"
	4HF4-S	1/2" - 14 NPTF	303 stainless	2.86	72.6	1.86	47.2	1-5/16"
	4HF4-SS	1/2" - 14 NPTF	316 stainless	2.86	72.6	1.86	47.2	1-1/16"
	4HBF4	1/2" - 14 BSPP	steel	2.86	72.6	1.86	47.2	1-5/16"
	4HBF4-B	1/2" - 14 BSPP	brass	2.86	72.6	1.86	47.2	1-5/16"
	4HBF4-S	1/2" - 14 BSPP	303 stainless	2.86	72.6	1.86	47.2	1-5/16"
	4HBF4-SS	1/2" - 14 BSPP	316 stainless	2.86	72.6	1.86	47.2	1-1/16"
	4HOF5	7/8" - 14 ORB	steel	2.90	73.7	1.86	47.2	1-1/8"
3/4"	6HF6	3/4" - 14 NPTF	steel	3.55	90.2	2.22	56.4	1-5/16"
	6HF6-B	3/4" - 14 NPTF	brass	3.55	90.2	2.22	56.4	1-5/16"
	6HF6-S	3/4" - 14 NPTF	303 stainless	3.55	90.2	2.22	56.4	1-5/16"
	6HF6-SS	3/4" - 14 NPTF	316 stainless	3.55	90.2	2.22	56.4	1-5/16"
	6HBF6	3/4" - 14 BSPP	steel	3.55	90.2	2.22	56.4	1-5/16"
	6HBF6-B	3/4" - 14 BSPP	brass	3.55	90.2	2.22	56.4	1-5/16"
	6HBF6-S	3/4" - 14 BSPP	303 stainless	3.55	90.2	2.22	56.4	1-5/16"
	6HBF6-SS	3/4" - 14 BSPP	316 stainless	3.55	90.2	2.22	56.4	1-5/16"
	6HOF6	1-1/16" - 12 ORB	steel	3.69	93.7	2.22	56.4	1-5/16"
1"	8HF8	1" - 11-1/2 NPTF	steel	4.13	104.9	2.49	63.2	1-5/8"
	8HF8-B	1" - 11-1/2 NPTF	brass	4.13	104.9	2.49	63.2	1-5/8"
	8HF8-S	1" - 11-1/2 NPTF	303 stainless	4.13	104.9	2.49	63.2	1-5/8"
	8HF8-SS	1" - 11-1/2 NPTF	316 stainless	4.13	104.9	2.49	63.2	1-5/8"
	8HBF8	1" - 11 BSPP	steel	4.13	104.9	2.49	63.2	1-5/8"
	8HBF8-B	1" - 11 BSPP	brass	4.13	104.9	2.49	63.2	1-5/8"
	8HBF8-S	1" - 11 BSPP	303 stainless	4.13	104.9	2.49	63.2	1-5/8"
	8HBF8-SS	1" - 11 BSPP	316 stainless	4.13	104.9	2.49	63.2	1-5/8"
	8HOF8	1-5/16" - 12 ORB	steel	4.19	106.3	2.49	63.2	1-5/8"

Hydraulic Couplings: H-Series

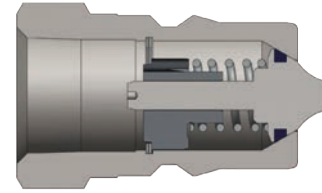

H-Series ISO-B Interchange Plug (Female Threads)

Body Size	H-Series ISO-B Interchange Plug (Female Threads)							
	Part Detail			Length		Maximum O.D.		Hex Inch
	Part #	Threads	Material	Inch	mm	Inch	mm	
1/8"	H1F1	1/8" - 27 NPTF	steel	1.28	32.5	0.65	16.5	9/16"
	H1F1-B	1/8" - 27 NPTF	brass	1.28	32.5	0.65	16.5	9/16"
	H1F1-S	1/8" - 27 NPTF	303 stainless	1.28	32.5	0.65	16.5	9/16"
	H1F1-SS	1/8" - 27 NPTF	316 stainless	1.28	32.5	0.65	16.5	9/16"
	H1OF2	7/16" - 20 ORB	steel	1.28	32.5	0.65	16.5	9/16"
1/4"	H2F2	1/4" - 18 NPTF	steel	1.55	39.4	0.83	21.1	3/4"
	H2F2-B	1/4" - 18 NPTF	brass	1.55	39.4	0.83	21.1	3/4"
	H2F2-S	1/4" - 18 NPTF	303 stainless	1.55	39.4	0.83	21.1	3/4"
	H2F2-SS	1/4" - 18 NPTF	316 stainless	1.55	39.4	0.83	21.1	3/4"
	H2BF2	1/4" - 19 BSPP	steel	1.55	39.4	0.83	21.1	3/4"
	H2BF2-B	1/4" - 19 BSPP	brass	1.55	39.4	0.83	21.1	3/4"
	H2BF2-S	1/4" - 19 BSPP	303 stainless	1.55	39.4	0.83	21.1	3/4"
	H2BF2-SS	1/4" - 19 BSPP	316 stainless	1.55	39.4	0.83	21.1	3/4"
	H2OF3	9/16" - 18 ORB	steel	1.61	40.9	0.90	22.9	13/16"
3/8"	H3F3	3/8" - 18 NPTF	steel	1.70	43.2	0.97	24.6	7/8"
	H3F3-B	3/8" - 18 NPTF	brass	1.70	43.2	0.97	24.6	7/8"
	H3F3-S	3/8" - 18 NPTF	303 stainless	1.70	43.2	0.97	24.6	7/8"
	H3F3-SS	3/8" - 18 NPTF	316 stainless	1.70	43.2	0.97	24.6	7/8"
	H3BF3	3/8" - 19 BSPP	steel	1.70	43.2	0.97	24.6	7/8"
	H3BF3-B	3/8" - 19 BSPP	brass	1.70	43.2	0.97	24.6	7/8"
	H3BF3-S	3/8" - 19 BSPP	303 stainless	1.70	43.2	0.97	24.6	7/8"
	H3BF3-SS	3/8" - 19 BSPP	316 stainless	1.70	43.2	0.97	24.6	7/8"
1/2"	H4F4	1/2" - 14 NPTF	steel	1.94	49.3	1.17	29.7	1-1/16"
	H4F4-B	1/2" - 14 NPTF	brass	1.94	49.3	1.17	29.7	1-1/16"
	H4F4-S	1/2" - 14 NPTF	303 stainless	1.94	49.3	1.17	29.7	1-1/16"
	H4F4-SS	1/2" - 14 NPTF	316 stainless	1.94	49.3	1.17	29.7	1-1/16"
	H4BF4	1/2" - 14 BSPP	steel	1.94	49.3	1.17	29.7	1-1/16"
	H4BF4-B	1/2" - 14 BSPP	brass	1.94	49.3	1.17	29.7	1-1/16"
	H4BF4-S	1/2" - 14 BSPP	303 stainless	1.94	49.3	1.17	29.7	1-1/16"
	H4BF4-SS	1/2" - 14 BSPP	316 stainless	1.94	49.3	1.17	29.7	1-1/16"
	H4OF5	7/8" - 14 ORB	steel	1.94	49.3	1.24	31.5	1-1/8"
3/4"	H6F6	3/4" - 14 NPTF	steel	2.44	61.2	1.50	36.6	1-3/8"
	H6F6-B	3/4" - 14 NPTF	brass	2.44	61.2	1.50	36.6	1-3/8"
	H6F6-S	3/4" - 14 NPTF	303 stainless	2.44	61.2	1.50	36.6	1-3/8"
	H6F6-SS	3/4" - 14 NPTF	316 stainless	2.44	61.2	1.50	36.6	1-3/8"
	H6BF6	3/4" - 14 BSPP	steel	2.44	61.2	1.50	36.6	1-3/8"
	H6BF6-B	3/4" - 14 BSPP	brass	2.44	61.2	1.50	36.6	1-3/8"
	H6BF6-S	3/4" - 14 BSPP	303 stainless	2.44	61.2	1.50	36.6	1-3/8"
	H6BF6-SS	3/4" - 14 BSPP	316 stainless	2.44	61.2	1.50	36.6	1-3/8"
	H6OF6	1-1/16" - 12 ORB	steel	2.58	61.2	1.50	36.6	1-3/8"
1"	H8F8	1" - 11-1/2 NPTF	steel	2.87	72.9	1.79	45.5	1-5/8"
	H8F8-B	1" - 11-1/2 NPTF	brass	2.87	72.9	1.79	45.5	1-5/8"
	H8F8-S	1" - 11-1/2 NPTF	303 stainless	2.87	72.9	1.79	45.5	1-5/8"
	H8F8-SS	1" - 11-1/2 NPTF	316 stainless	2.87	72.9	1.79	45.5	1-5/8"
	H8BF8	1" - 11 BSPP	steel	2.87	72.9	1.79	45.5	1-5/8"
	H8BF8-B	1" - 11 BSPP	brass	2.87	72.9	1.79	45.5	1-5/8"
	H8BF8-S	1" - 11 BSPP	303 stainless	2.87	72.9	1.79	45.5	1-5/8"
	H8BF8-SS	1" - 11 BSPP	316 stainless	2.87	72.9	1.79	45.5	1-5/8"
	H8OF8	1-5/16" - 12 ORB	steel	2.87	72.9	1.79	45.5	1-5/8"

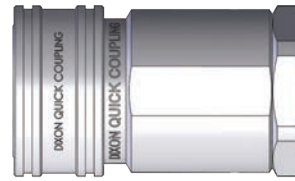
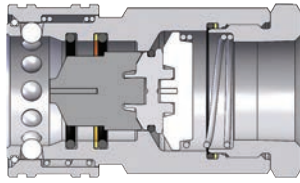

Body Size	H-Series ISO-B High Volume Interchange Coupler (Female Threads)							
	Part Detail			Length		Maximum O.D.		Hex Inch
	Part #	Threads	Material	Inch	mm	Inch	mm	
1-1/4"	10HF10	1-1/4" - 11-1/2 NPTF	steel	4.43	112.5	2.60	66.0	2-3/8"
	10HF10-B	1-1/4" - 11-1/2 NPTF	brass	4.43	112.5	2.60	66.0	2-3/8"
	10HF10-S	1-1/4" - 11-1/2 NPTF	303 stainless	4.43	112.5	2.60	66.0	2-3/8"
	10HF10-SS	1-1/4" - 11-1/2 NPTF	316 stainless	4.43	112.5	2.60	66.0	2-3/8"
	10HBF10	1-1/4" - 11 BSPP	steel	4.43	112.5	2.60	66.0	2-3/8"
	10HBF10-B	1-1/4" - 11 BSPP	brass	4.43	112.5	2.60	66.0	2-3/8"
	10HBF10-S	1-1/4" - 11 BSPP	303 stainless	4.43	112.5	2.60	66.0	2-3/8"
	10HBF10-SS	1-1/4" - 11 BSPP	316 stainless	4.43	112.5	2.60	66.0	2-3/8"
1-1/2"	12HF10	1-1/4" - 11-1/2 NPTF	steel	4.81	122.2	3.00	76.2	2-5/8"
	12HF10-B	1-1/4" - 11-1/2 NPTF	brass	4.81	122.2	3.00	76.2	2-5/8"
	12HF10-S	1-1/4" - 11-1/2 NPTF	303 stainless	4.81	122.2	3.00	76.2	2-5/8"
	12HF10-SS	1-1/4" - 11-1/2 NPTF	316 stainless	4.81	122.2	3.00	76.2	2-5/8"
	12HOF10	1-5/8" - 12 ORB	steel	4.81	122.2	3.00	76.2	2-5/8"
	12HF12	1-1/2" - 11-1/2 NPTF	steel	4.81	122.2	3.00	76.2	2-5/8"
	12HF12-B	1-1/2" - 11-1/2 NPTF	brass	4.81	122.2	3.00	76.2	2-5/8"
	12HF12-S	1-1/2" - 11-1/2 NPTF	303 stainless	4.81	122.2	3.00	76.2	2-5/8"
	12HF12-SS	1-1/2" - 11-1/2 NPTF	316 stainless	4.81	122.2	3.00	76.2	2-5/8"
	12HBF12	1-1/2" - 11 BSPP	steel	4.81	122.2	3.00	76.2	2-5/8"
	12HBF12-B	1-1/2" - 11 BSPP	brass	4.81	122.2	3.00	76.2	2-5/8"
	12HBF12-S	1-1/2" - 11 BSPP	303 stainless	4.81	122.2	3.00	76.2	2-5/8"
	12HBF12-SS	1-1/2" - 11 BSPP	316 stainless	4.81	122.2	3.00	76.2	2-5/8"
	12HOF12	1-7/8" - 12 ORB	steel	4.81	122.2	3.00	76.2	2-5/8"
2-1/2"	20HF16	2" - 11-1/2 NPTF	steel	5.57	141.5	4.10	104.1	3-3/4"
	20HF16-B	2" - 11-1/2 NPTF	brass	5.57	141.5	4.10	104.1	3-3/4"
	20HF20	2-1/2" - 8 NPTF	steel	6.04	153.4	4.10	104.1	3-3/4"
	20HF24	3" - 8 NPTF	steel	6.96	176.8	4.35	110.5	4"

Hydraulic Couplings: H-Series

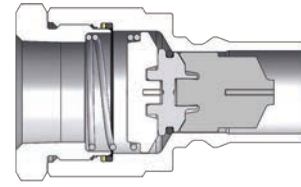
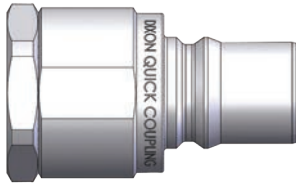

Body Size	H-Series ISO-B High Volume Interchange Plug (Female Threads)							
	Part Detail			Length		Maximum O.D.		Hex Inch
	Part #	Threads	Material	Inch	mm	Inch	mm	
1-1/4"	H10F10	1-1/4" - 11-1/2 NPTF	steel	4.25	108.0	2.60	66.0	2-3/8"
	H10F10-B	1-1/4" - 11-1/2 NPTF	brass	4.25	108.0	2.60	66.0	2-3/8"
	H10F10-S	1-1/4" - 11-1/2 NPTF	303 stainless	4.25	108.0	2.60	66.0	2-3/8"
	H10F10-SS	1-1/4" - 11-1/2 NPTF	316 stainless	4.25	108.0	2.60	66.0	2-3/8"
	H10BF10	1-1/4" - 11-BSPP	steel	4.25	108.0	2.60	66.0	2-3/8"
	H10BF10-B	1-1/4" - 11-BSPP	brass	4.25	108.0	2.60	66.0	2-3/8"
	H10BF10-S	1-1/4" - 11-BSPP	303 stainless	4.25	108.0	2.60	66.0	2-3/8"
	H10BF10-SS	1-1/4" - 11-BSPP	316 stainless	4.25	108.0	2.60	66.0	2-3/8"
1-1/2"	H12F10	1-1/4" - 11-1/2 NPTF	steel	4.76	120.9	2.88	73.2	2-5/8"
	H12F10-B	1-1/4" - 11-1/2 NPTF	brass	4.76	120.9	2.88	73.2	2-5/8"
	H12F10-S	1-1/4" - 11-1/2 NPTF	303 stainless	4.76	120.9	2.88	73.2	2-5/8"
	H12F10-SS	1-1/4" - 11-1/2 NPTF	316 stainless	4.76	120.9	2.88	73.2	2-5/8"
	H120F10	1-5/8" - 12 ORB	steel	4.76	120.9	2.88	73.2	2-5/8"
	H12F12	1-1/2" - 11-1/2 NPTF	steel	4.76	120.9	2.88	73.2	2-5/8"
	H12F12-B	1-1/2" - 11-1/2 NPTF	brass	4.76	120.9	2.88	73.2	2-5/8"
	H12F12-S	1-1/2" - 11-1/2 NPTF	303 stainless	4.76	120.9	2.88	73.2	2-5/8"
	H12F12-SS	1-1/2" - 11-1/2 NPTF	316 stainless	4.76	120.9	2.88	73.2	2-5/8"
	H12BF12	1-1/2" - 11 BSPP	steel	4.76	120.9	2.88	73.2	2-5/8"
	H12BF12-B	1-1/2" - 11 BSPP	brass	4.76	120.9	2.88	73.2	2-5/8"
	H12BF12-S	1-1/2" - 11 BSPP	303 stainless	4.76	120.9	2.88	73.2	2-5/8"
	H12BF12-SS	1-1/2" - 11 BSPP	316 stainless	4.76	120.9	2.88	73.2	2-5/8"
	H120F12	1-7/8" - 12 ORB	steel	4.76	120.9	2.88	73.2	2-5/8"
2-1/2"	H20F16	2" - 11-1/2 NPTF	steel	5.48	139.2	4.10	104.1	3-3/4"
	H20F16-B	2" - 11-1/2 NPTF	brass	5.48	139.2	4.10	104.1	3-3/4"
	H20F20	2-1/2" - 8 NPTF	steel	5.95	151.1	4.10	104.1	3-3/4"
	H20F24	3" - 8 NPTF	steel	6.87	174.5	4.35	110.5	4"

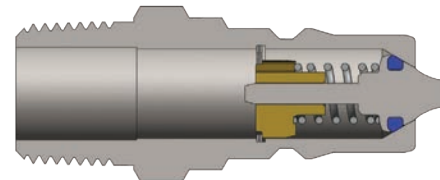

Body Size	H-Series ISO-B Interchange Plug (Male Threads)							
	Part Detail			Length		Maximum O.D.		Hex Inch
	Part #	Threads	Material	Inch	mm	Inch	mm	
1/4"	H2M2	1/4" - 18 NPTF	steel	2.04	51.82	0.97	24.64	7/8"
1/4"	H2M3	3/8" - 18 NPTF	steel	2.03	51.6	0.83	21.1	3/4"
1/2"	H4M6-S	3/4" - 14 NPTF	303 stainless	2.13	58.7	1.17	29.7	1-1/16"

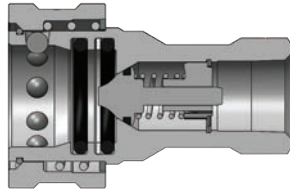

Body Size	H-Series ISO-B Steel Mill 'Slide Gate' Coupler (Female Threads)							
	Part Detail			Length		Maximum O.D.		Hex Inch
	Part #	Threads	Material	Inch	mm	Inch	mm	
1/2"	4HF4-HV	1/2" - 14 NPTF	steel	2.86	72.6	1.86	47.2	1-1/16"
	F-4HF4-HV	1/2" - 14 NPTF	steel	2.86	72.60	1.86	47.20	1-1/16"

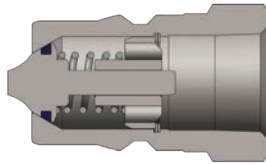

Body Size	H-Series ISO-B Steel Mill 'Slide Gate' Plug (Female Threads)							
	Part Detail			Length		Maximum O.D.		Hex Inch
	Part #	Threads	Material	Inch	mm	Inch	mm	
1/2"	H4F4-HV	1/2" - 14 NPTF	steel	1.94	49.3	1.17	29.7	1-1/16"
	F-H4F4-HV	1/2" - 14 NPTF	steel	1.94	49.30	1.17	29.70	1-1/16"

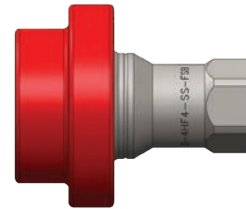
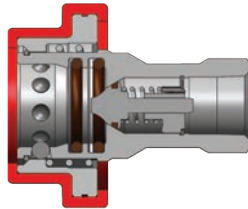

Body Size	H-Series ISO-B Fry Oil Silicone Flanged Coupler (Female Threads)							
	Part Detail			Length		Maximum O.D.		Hex Inch
	Part #	Threads	Material	Inch	mm	Inch	mm	
1/2"	D-4HF4-S-FSB	1/2" - 14 NPTF	303 stainless	2.86	72.6	2.52	64.0	1-1/16"
	D-4HF4-SS-FSB	1/2" - 14 NPTF	316 stainless	2.86	72.6	2.52	64.0	1-1/16"

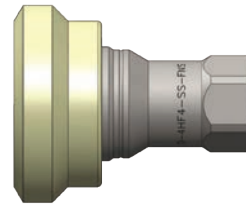
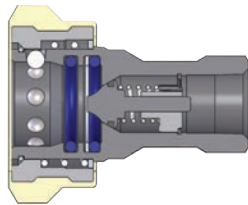

Body Size	H-Series ISO-B Fry Oil Nylon Flanged Coupler (Female Threads)							
	Part Detail			Length		Maximum O.D.		Hex Inch
	Part #	Threads	Material	Inch	mm	Inch	mm	
1/2"	D-4HF4-S-FNS	1/2" - 14 NPTF	303 stainless	2.86	72.6	2.38	60.5	1-1/16"
	D-4HF4-SS-FNS	1/2" - 14 NPTF	316 stainless	2.86	72.6	2.38	60.5	1-1/16"

Hydraulic Couplings: H-Series

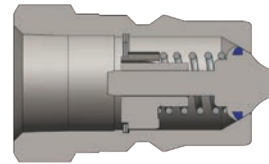

Body Size	H-Series ISO-B Fry Oil Plug (Female Threads)							
	Part Detail			Length		Maximum O.D.		Hex Inch
	Part #	Threads	Material	Inch	mm	Inch	mm	
1/2"	D-H4F4-SV-8	1/2" - 14 NPTF	steel	1.94	49.3	1.17	29.7	1-1/16"
	D-H4F4-S	1/2" - 14 NPTF	303 stainless	1.94	49.3	1.17	29.7	1-1/16"
	D-H4F4-SS	1/2" - 14 NPTF	316 stainless	1.94	49.3	1.17	29.7	1-1/16"

Available Options

Body Size	Standard Seal Options								Kalrez® Seal Options		
	FKM	EPDM	Steam-EP	FDA FKM	Mil-Nitrile	Fuel Nitrile	PTFE	Silicone	4079	6375	7075
1/8"	F-	P-	N/A	N/A	N/A	N/A	N/A	N/A	K4-	K6-	K7-
1/4"	F-	P-	PS-	D-	M-	JF-	TS-	S-	K4-	K6-	K7-
3/8"	F-	P-	PS-	D-	M-	JF-	TS-	S-	K4-	K6-	K7-
1/2"	F-	P-	PS-	D-	M-	JF-	TS-	S-	K4-	K6-	K7-
3/4"	F-	P-	PS-	D-	M-	JF-	TS-	S-	K4-	K6-	K7-
1"	F-	P-	PS-	D-	M-	JF-	TS-	S-	K4-	K6-	K7-
1-1/4"	F-	P-	PS-	D-	M-	JF-	N/A	S-	K4-	K6-	K7-
1-1/2"	F-	P-	PS-	D-	M-	JF-	N/A	S-	K4-	K6-	K7-
2-1/2"	N/A	N/A	N/A	N/A	N/A	N/A	N/A	N/A	N/A	N/A	N/A

Body Size	Valve Options						Sleeve Options			Treatments
	Unvalved	Actuator ¹	Steel	Brass	303 SS	316 SS	Sleeve-Lock	Flanged	Sil-Flange	Oxy-Clean
1/8"	-E	N/A	-ZV	-BV	N/A	N/A	-LS	N/A	N/A	-C1
1/4"	-E	-VA	-ZV	-BV	-SV	SSV	-LS	-FS	N/A	-C1
3/8"	-E	-VA	-ZV	-BV	-SV	SSV	-LS	-FS	N/A	-C1
1/2"	-E	-VA	-ZV	-BV	-SV	SSV	-LS	-FS	FSB	-C1
3/4"	-E	-VA	-ZV	-BV	-SV	SSV	-LS	-FS	N/A	-C1
1"	-E	-VA	-ZV	-BV	-SV	SSV	-LS	-FS	N/A	-C1
1-1/4"	-E	N/A	-ZV	-BV	-SV	SSV	-LS	N/A	N/A	-C1
1-1/2"	-E	N/A	-ZV	-BV	-SV	SSV	-LS	N/A	N/A	-C1
2-1/2"	N/A	N/A	N/A	N/A	N/A	N/A	N/A	N/A	N/A	N/A

¹ brass valve actuator

H Series Profiles

Body Size	A	B
1/8"	0.43	0.32
1/4"	0.56	0.39
3/8"	0.48	0.50
1/2"	0.92	0.49
3/4"	1.24	0.75
1"	1.49	0.82
1-1/4"	1.49	1.13
1-1/2"	1.75	1.29
2-1/2"	2.50	1.50

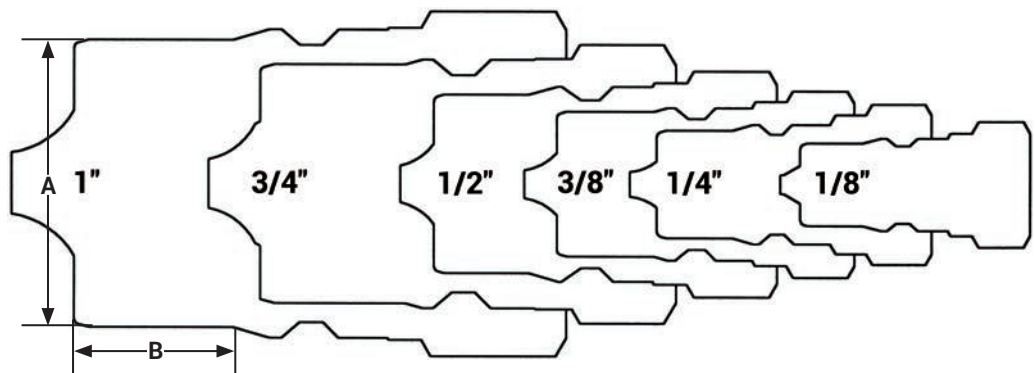



Body Size	H-Series ISO-B Interchange Dust Caps and Plugs		
	Part Detail		
	Coupler Dust Plug	Plug Dust Cap	Material
1/8"	1HDP	H1DC	Nitrile
1/4"	2HDP-H2DC combo plug/cap		Nitrile
3/8"	3HDP-H3DC combo plug/cap		Nitrile
1/2"	4HDP-H4DC combo plug/cap		Nitrile
3/4"	6HDP-H6DC combo plug/cap		Nitrile
1"	8HDP-H8DC combo plug/cap ¹		Nitrile

¹8HDP-H8DC fits both 1" and 1-1/4" body sizes



Body Size	H-Series ISO-B Interchange Coupler Rigid Dust Plug		
	Part Detail		
	Part #	Lanyard	Body
1/4"	2HDP-A	steel cable	aluminum
3/8"	3HDP-A	steel cable	aluminum
1/2"	4HDP-A	steel cable	aluminum
3/4"	6HDP-A	steel cable	aluminum
1"	8HDP-A	steel cable	aluminum
1-1/2"	12HDP-A	steel cable	aluminum
2-1/2"	20HDP-A	steel cable	aluminum

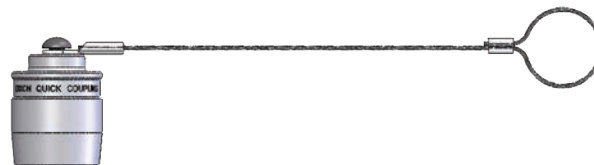

Body Size	H-Series ISO-B Interchange Plug Rigid Dust Cap				
	Part Detail			Package Qty	
	Part #	Lanyard	Body	Bag	Box
1/4"	H2DC-A	steel cable	aluminum	10	50
3/8"	H3DC-A	steel cable	aluminum	10	50
1/2"	H4DC-A	steel cable	aluminum	10	50
3/4"	H6DC-A	steel cable	aluminum	5	25
1"	H8DC-A	steel cable	aluminum	5	25
1-1/2"	H12DC-A	steel cable	aluminum	-	10
2-1/2"	H20DC-A	steel cable	aluminum	-	5

Body Size	H-Series ISO-B Coupler Seal Kits			
	Part Detail			Seal Kit Contents
	Part #	Coupler Style	Seal Material	
1/8"	1H-SKIT	steel, 303 SS, 316 SS, brass	Nitrile	two O-rings and one PTFE anti-extrusion ring
	F-1H-SKIT	steel, 303 SS, 316 SS, brass	FKM	two O-rings and one PTFE anti-extrusion ring
	P-1H-SKIT	steel, 303 SS, 316 SS, brass	EPDM	two O-rings and one PTFE anti-extrusion ring
1/4"	2H-SKIT	steel, 303 SS, 316 SS, brass	Nitrile	two O-rings and one PTFE anti-extrusion ring
	F-2H-SKIT	steel, 303 SS, 316 SS, brass	FKM	two O-rings and one PTFE anti-extrusion ring
	P-2H-SKIT	steel, 303 SS, 316 SS, brass	EPDM	two O-rings and one PTFE anti-extrusion ring
3/8"	3H-SKIT	steel, 303 SS, 316 SS, brass	Nitrile	two O-rings and one PTFE anti-extrusion ring
	F-3H-SKIT	steel, 303 SS, 316 SS, brass	FKM	two O-rings and one PTFE anti-extrusion ring
	P-3H-SKIT	steel, 303 SS, 316 SS, brass	EPDM	two O-rings and one PTFE anti-extrusion ring
1/2"	4H-SKIT	steel, 303 SS, 316 SS, brass	Nitrile	two O-rings and one PTFE anti-extrusion ring
	F-4H-SKIT	steel, 303 SS, 316 SS, brass	FKM	two O-rings and one PTFE anti-extrusion ring
	P-4H-SKIT	steel, 303 SS, 316 SS, brass	EPDM	two O-rings and one PTFE anti-extrusion ring
3/4"	6H-SKIT	steel, 303 SS, 316 SS, brass	Nitrile	two O-rings and one PTFE anti-extrusion ring
	F-6H-SKIT	steel, 303 SS, 316 SS, brass	FKM	two O-rings and one PTFE anti-extrusion ring
	P-6H-SKIT	steel, 303 SS, 316 SS, brass	EPDM	two O-rings and one PTFE anti-extrusion ring
1"	8H-SKIT	steel, 303 SS, 316 SS, brass	Nitrile	two O-rings and one PTFE anti-extrusion ring
	F-8H-SKIT	steel, 303 SS, 316 SS, brass	FKM	two O-rings and one PTFE anti-extrusion ring
	P-8H-SKIT	steel, 303 SS, 316 SS, brass	EPDM	two O-rings and one PTFE anti-extrusion ring
1-1/4"	10H-SKIT	steel, 303 SS, 316 SS, brass	Nitrile	adapter/valve O-ring and two body O-rings
	F-10-SKIT	steel, 303 SS, 316 SS, brass	FKM	adapter/valve O-ring and two body O-rings
	P-10-SKIT	steel, 303 SS, 316 SS, brass	EPDM	adapter/valve O-ring and two body O-rings
1-1/2"	12H-SKIT	steel, 303 SS, 316 SS, brass	Nitrile	adapter/valve O-ring and two body O-rings
	F-12H-SKIT	steel, 303 SS, 316 SS, brass	FKM	adapter/valve O-ring and two body O-rings
	P-12H-SKIT	steel, 303 SS, 316 SS, brass	EPDM	adapter/valve O-ring and two body O-rings

Body Size	H-Series ISO-B Repair Kits			
	Part Detail			Repair Kit Contents (for one coupler or plug)
	Part #	Coupler Style	Seal Material	
1/4"	2H-RKIT	steel	Nitrile	steel valve assembly and retaining ring
	2H-BRKIT	brass	Nitrile	brass valve assembly and retaining ring
	2H-SRKIT	303 stainless	Nitrile	303 SS valve assembly and retaining ring
	2H-SSRKIT	316 stainless	Nitrile	316 SS valve assembly and retaining ring
3/8"	3H-RKIT	steel	Nitrile	steel valve assembly and retaining ring
	3H-BRKIT	brass	Nitrile	brass valve assembly and retaining ring
	3H-SRKIT	303 stainless	Nitrile	303 SS valve assembly and retaining ring
	3H-SSRKIT	316 stainless	Nitrile	316 SS valve assembly and retaining ring
1/2"	4H-RKIT	steel	Nitrile	steel valve assembly and retaining ring
	4H-BRKIT	brass	Nitrile	brass valve assembly and retaining ring
	4H-SRKIT	303 stainless	Nitrile	303 SS valve assembly and retaining ring
	4H-SSRKIT	316 stainless	Nitrile	316 SS valve assembly and retaining ring
3/4"	6H-RKIT	steel	Nitrile	steel valve assembly and retaining ring
	6H-BRKIT	brass	Nitrile	brass valve assembly and retaining ring
	6H-SRKIT	303 stainless	Nitrile	303 SS valve assembly and retaining ring
	6H-SSRKIT	316 stainless	Nitrile	316 SS valve assembly and retaining ring
1"	8H-RKIT	steel	Nitrile	steel valve assembly and retaining ring
	8H-BRKIT	brass	Nitrile	brass valve assembly and retaining ring
	8H-SRKIT	303 stainless	Nitrile	303 SS valve assembly and retaining ring
	8H-SSRKIT	316 stainless	Nitrile	316 SS valve assembly and retaining ring
1-1/4"	10H-RKIT	steel	Nitrile	steel valve assembly and adapter O-ring
	10H-BRKIT	brass	Nitrile	brass valve assembly and adapter O-ring
	10H-SRKIT	303 stainless	Nitrile	303 SS valve assembly and adapter O-ring
	10H-SSRKIT	316 stainless	Nitrile	316 SS valve assembly and adapter O-ring
1-1/2"	12H-RKIT	steel	Nitrile	steel valve assembly and adapter O-ring
	12H-BRKIT	brass	Nitrile	brass valve assembly and adapter O-ring
	12H-SRKIT	303 stainless	Nitrile	303 SS valve assembly and adapter O-ring
	12H-SSRKIT	316 stainless	Nitrile	316 SS valve assembly and adapter O-ring

Hydraulic Couplings: H-BOP-Series

Interchange Data

- Interchangeable to ISO7241 Series B
- Eaton/Hansen HKFR-Series, DNP HNV-BOP-Series

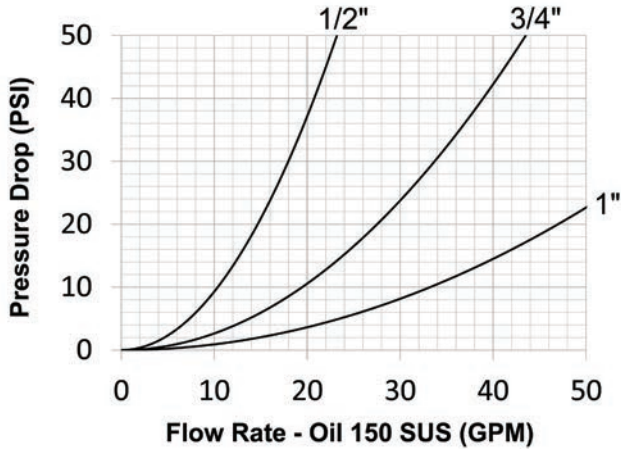

Seal Components

- Blow-out preventer (BOP) couplings contain severe service FKM seals
- PTFE anti-extrusion ring protects main coupling body seal from dynamic impulse pressure damage
- Coupler has redundant O-ring sealing system
- Valve seals are crimped in place to maintain integrity during excessive flow conditions and pressurized connection

Materials

- Machined components are manufactured using solid steel or 316 stainless steel bar stock
- Stainless steel balls, retaining rings, and springs maximize corrosion resistance and extend service life
- Steel componentry is plated using ROHS-compliant zinc-nickel
- Steel coupler sleeves are hardened to resist deformation and maximize service life
- Steel plugs are hardened to provide heavy-duty performance and resist brinelling
- Red powder coated coupler sleeve and plug hex for easy BOP service identification
- Locking sleeve is standard

- BOP couplings have been fire tested and Lloyd's certified to 1300°F (700°C) in accordance with API 16D. Certificate available upon request.
- Use H-Series dust caps and dust plugs found on page 77

Rated Pressure Chart

Body Size	H-BOP-Series Blowout Preventer Safety Interchange									
	Steel Coupler/Plug				316 SS Coupler/Plug				Lloyd's Test Pressure	Flow ΔP = 22 PSI
	Maximum Working		Burst		Maximum Working		Burst			
	PSI	Bar	PSI	Bar	PSI	Bar	PSI	Bar		
3/8"	5,000	345	16,500	1,150	5,000	345	21,500	1,450	5,000	12 GPM
1/2"	5,000	345	16,000	1,100	5,000	345	22,000	1,500	5,000	15 GPM
3/4"	5,000	345	16,500	1,150	5,000	345	21,500	1,450	5,000	29 GPM
1"	5,000	345	16,000	1,100	5,000	345	15,000	1,000	5,000	50 GPM

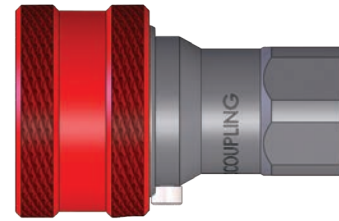
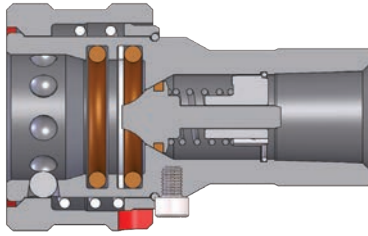

Body Size	H-BOP-Series Blowout Preventer Safety Coupler (Female Threads)							
	Part Detail			Length		Maximum O.D.		Hex mm
	Part #	Threads	Material	Inch	mm	Inch	mm	
3/8"	3HF3-BOP	3/8" - 18 NPTF	steel	2.50	63.5	1.41	35.8	7/8"
	3HF3-SS-BOP	3/8" - 18 NPTF	316 stainless	2.50	63.5	1.41	35.8	7/8"
1/2"	4HF4-BOP	1/2" - 14 NPTF	steel	2.86	72.6	1.86	47.2	1-5/16"
	4HF4-SS-BOP	1/2" - 14 NPTF	316 stainless	2.86	72.6	1.86	47.2	1-5/16"
3/4"	6HF6-BOP	3/4" - 14 NPTF	steel	3.55	90.2	2.22	56.4	1-5/16"
	6HF6-SS-BOP	3/4" - 14 NPTF	316 stainless	3.55	90.2	2.22	56.4	1-5/16"
1"	8HF8-BOP	1" - 11-1/2 NPTF	steel	4.13	104.9	2.49	63.2	1-5/8"
	8HF8-SS-BOP	1" - 11-1/2 NPTF	316 stainless	4.13	104.9	2.49	63.2	1-5/8"

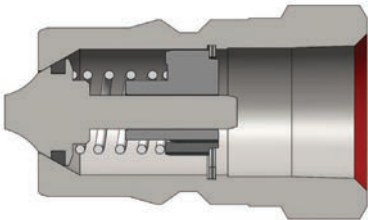

Body Size	H-BOP-Series Blowout Preventer Safety Plug (Female Threads)							
	Part Detail			Length		Maximum O.D.		Hex mm
	Part #	Threads	Material	Inch	mm	Inch	mm	
3/8"	H3F3-BOP	3/8" - 18 NPTF	steel	1.53	38.9	0.96	24.4	7/8"
	H3F3-SS-BOP	3/8" - 18 NPTF	316 stainless	1.53	38.9	0.96	24.4	7/8"
1/2"	H4F4-BOP	1/2" - 14 NPTF	steel	1.94	49.3	1.17	29.7	1-1/16"
	H4F4-SS-BOP	1/2" - 14 NPTF	316 stainless	1.94	49.3	1.17	29.7	1-1/16"
3/4"	H6F6-BOP	3/4" - 14 NPTF	steel	2.41	61.2	1.44	36.6	1-5/16"
	H6F6-SS-BOP	3/4" - 14 NPTF	316 stainless	2.41	61.2	1.44	36.6	1-5/16"
1"	H8F8-BOP	1" - 11-1/2 NPTF	steel	2.87	72.9	1.79	45.5	1-5/8"
	H8F8-SS-BOP	1" - 11-1/2 NPTF	316 stainless	2.87	72.9	1.79	45.5	1-5/8"

Hydraulic Couplings: HS-Series

Interchange Data

- Interchangeable to ISO7241 Series B
- Parker 60-Series steam couplings

Materials

- Machined components are manufactured using solid steel, brass, or 303 stainless steel bar stock
- Stainless steel balls, retaining rings, and springs maximize corrosion resistance and extend service life
- Steel componentry is plated using ROHS-compliant trivalent chrome
- Steel plugs are hardened to provide heavy-duty performance and resist brinelling
- All couplers have a steel steam-sleeve as standard

Seal Components

- EPDM steam-grade seals are standard, providing a temperature range of **-70°F to 400°F (-57°C to 204°C)**
- Couplers have a redundant O-ring sealing system (dual O-rings with PTFE back-up)
- Valve seals are crimped in place to maintain integrity during excessive flow conditions

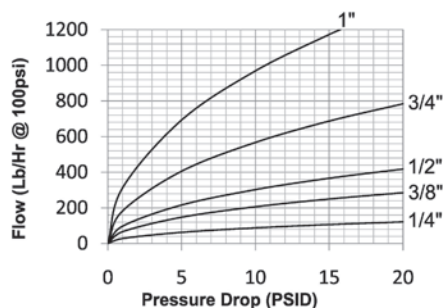

Rated Pressure Chart

Body Size	HS-Series ISO-B Steam Interchange (Connected)															
	Brass Coupler/Plug				Brass Coupler/Steel Plug				Brass Coupler/303 SS Plug				303 SS Coupler/Plug			
	Max. Working		Burst		Max. Working		Burst		Max. Working		Burst		Max. Working		Burst	
	PSI	Bar	PSI	Bar	PSI	Bar	PSI	Bar	PSI	Bar	PSI	Bar	PSI	Bar	PSI	Bar
1/4"	200	14	14,500	1,000	200	14	14,500	1,000	200	14	14,500	1,000	200	14	31,500	2,150
3/8"	200	14	12,000	800	200	14	14,500	1,000	200	14	14,500	1,000	200	14	26,500	1,800
1/2"	200	14	11,500	750	200	14	14,500	1,000	200	14	14,500	1,000	200	14	27,500	1,900
3/4"	200	14	9,280	640	200	14	9,280	640	200	14	9,280	640	200	14	16,000	1,100
1"	200	14	5,800	400	200	14	5,800	400	200	14	5,800	400	200	14	15,000	1,000

Technical Specifications

Body Size	Interchange Standards				Functional Parameters				
	U.S. Military	U.S. Government	International Standards	ANSI/NFPA Standards	Locking Ball Quantity	Air Inclusion	Fluid Loss	Vacuum Inch HG	Flow ΔP = 10 PSI
1/4"	-	-	ISO7241 B	B93.113M-B	8	1.1cc	0.9cc	27.4	88Lbs/Hr
3/8"	-	-	ISO7241 B	B93.113M-B	9	2.6cc	1.8cc	27.4	206Lbs/Hr
1/2"	-	-	ISO7241 B	B93.113M-B	9	3.8cc	2.9cc	27.4	302Lbs/Hr
3/4"	-	-	ISO7241 B	B93.113M-B	12	10.8cc	9.7cc	27.4	567Lbs/Hr
1"	-	-	ISO7241 B	B93.113M-B	12	15.9cc	15.3cc	27.4	968Lbs/Hr

! Maximum working pressure has been calculated using saturated steam at **382°F (194°C)** for general purpose continuous steam service. For advanced operating pressure or super-heated steam applications, contact Dixon Quick Coupling for further information.

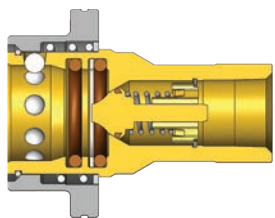

Body Size	H-Series ISO-B Steam Interchange Coupler (Female Threads)							
	Part Detail			Length		Maximum O.D.		Hex Inch
	Part #	Threads	Material	Inch	mm	Inch	mm	
1/4"	2HSF2-B	1/4" - 18 NPTF	brass	2.26	57.4	1.42	36.1	3/4"
	2HSF2-S	1/4" - 18 NPTF	303 stainless	2.26	57.4	1.42	36.1	3/4"
	2HSBF2-B	1/4" - 19 BSPP	brass	2.26	57.4	1.42	36.1	3/4"
	2HSBF2-S	1/4" - 19 BSPP	303 stainless	2.26	57.4	1.42	36.1	3/4"
3/8"	3HSF3-B	3/8" - 18 NPTF	brass	2.51	63.8	1.73	43.9	7/8"
	3HSF3-S	3/8" - 18 NPTF	303 stainless	2.51	63.8	1.73	43.9	7/8"
	3HSBF3-B	3/8" - 19 BSPP	brass	2.51	63.8	1.73	43.9	7/8"
	3HSBF3-S	3/8" - 19 BSPP	303 stainless	2.51	63.8	1.73	43.9	7/8"
1/2"	4HSF4-B	1/2" - 14 NPTF	brass	2.86	72.6	2.29	58.2	1-1/16"
	4HSF4-S	1/2" - 14 NPTF	303 stainless	2.86	72.6	2.29	58.2	1-1/16"
	4HSBF4-B	1/2" - 14 BSPP	brass	2.86	72.6	2.29	58.2	1-1/16"
	4HSBF4-S	1/2" - 14 BSPP	303 stainless	2.86	72.6	2.29	58.2	1-1/16"
3/4"	6HSF6-B	3/4" - 14 NPTF	brass	3.55	90.2	2.61	66.3	1-5/16"
	6HSF6-S	3/4" - 14 NPTF	303 stainless	3.55	90.2	2.61	66.3	1-5/16"
	6HSBF6-B	3/4" - 14 BSPP	brass	3.55	90.2	2.61	66.3	1-5/16"
	6HSBF6-S	3/4" - 14 BSPP	303 stainless	3.55	90.2	2.61	66.3	1-5/16"
1"	8HSF8-B	1" - 11-1/2 NPTF	brass	4.13	104.9	2.98	75.7	1-5/8"
	8HSF8-S	1" - 11-1/2 NPTF	303 stainless	4.13	104.9	2.98	75.7	1-5/8"
	8HSBF8-B	1" - 11 BSPP	brass	4.13	104.9	2.98	75.7	1-5/8"
	8HSBF8-S	1" - 11 BSPP	303 stainless	4.13	104.9	2.98	75.7	1-5/8"

! Do not disconnect steam couplings while under pressure. Maximum operating temperature for steam service couplings is **382°F (194°C)**, with an intermittent maximum temperature of **400°F (204°C)**. Be sure to use safety chains, or equivalent means, to prevent the line from thrashing around in a case where the coupling becomes disconnected.

Hydraulic Couplings: HS-Series

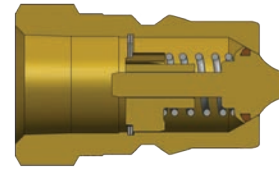

Body Size	H-Series ISO-B Steam Interchange Plug (Female Threads)							
	Part Detail			Length		Maximum O.D.		Hex Inch
	Part #	Threads	Material	Inch	mm	Inch	mm	
1/4"	HS2F2	1/4" - 18 NPTF	steel	1.55	39.4	0.83	21.1	3/4"
	HS2F2-B	1/4" - 18 NPTF	brass	1.55	39.4	0.83	21.1	3/4"
	HS2F2-S	1/4" - 18 NPTF	303 stainless	1.55	39.4	0.83	21.1	3/4"
	HS2BF2	1/4" - 19 BSPP	steel	1.55	39.4	0.83	21.1	3/4"
	HS2BF2-B	1/4" - 19 BSPP	brass	1.55	39.4	0.83	21.1	3/4"
	HS2BF2-S	1/4" - 19 BSPP	303 stainless	1.55	39.4	0.83	21.1	3/4"
3/8"	HS3F3	3/8" - 18 NPTF	steel	1.70	43.2	0.97	24.6	7/8"
	HS3F3-B	3/8" - 18 NPTF	brass	1.70	43.2	0.97	24.6	7/8"
	HS3F3-S	3/8" - 18 NPTF	303 stainless	1.70	43.2	0.97	24.6	7/8"
	HS3BF3	3/8" - 19 BSPP	steel	1.70	43.2	0.97	24.6	7/8"
	HS3BF3-B	3/8" - 19 BSPP	brass	1.70	43.2	0.97	24.6	7/8"
	HS3BF3-S	3/8" - 19 BSPP	303 stainless	1.70	43.2	0.97	24.6	7/8"
1/2"	HS4F4	1/2" - 14 NPTF	steel	1.94	49.3	1.17	29.7	1-1/16"
	HS4F4-B	1/2" - 14 NPTF	brass	1.94	49.3	1.17	29.7	1-1/16"
	HS4F4-S	1/2" - 14 NPTF	303 stainless	1.94	49.3	1.17	29.7	1-1/16"
	HS4BF4	1/2" - 14 BSPP	steel	1.94	49.3	1.17	29.7	1-1/16"
	HS4BF4-B	1/2" - 14 BSPP	brass	1.94	49.3	1.17	29.7	1-1/16"
	HS4BF4-S	1/2" - 14 BSPP	303 stainless	1.94	49.3	1.17	29.7	1-1/16"
3/4"	HS6F6	3/4" - 14 NPTF	steel	2.41	61.2	1.44	36.6	1-5/16"
	HS6F6-B	3/4" - 14 NPTF	brass	2.41	61.2	1.44	36.6	1-5/16"
	HS6F6-S	3/4" - 14 NPTF	303 stainless	2.41	61.2	1.44	36.6	1-5/16"
	HS6BF6	3/4" - 14 BSPP	steel	2.41	61.2	1.44	36.6	1-5/16"
	HS6BF6-B	3/4" - 14 BSPP	brass	2.41	61.2	1.44	36.6	1-5/16"
	HS6BF6-S	3/4" - 14 BSPP	303 stainless	2.41	61.2	1.44	36.6	1-5/16"
1"	HS8F8	1" - 11-1/2 NPTF	steel	2.87	72.9	1.79	45.5	1-5/8"
	HS8F8-B	1" - 11-1/2 NPTF	brass	2.87	72.9	1.79	45.5	1-5/8"
	HS8F8-S	1" - 11-1/2 NPTF	303 stainless	2.87	72.9	1.79	45.5	1-5/8"
	HS8BF8	1" - 11 BSPP	steel	2.87	72.9	1.79	45.5	1-5/8"
	HS8BF8-B	1" - 11 BSPP	brass	2.87	72.9	1.79	45.5	1-5/8"
	HS8BF8-S	1" - 11 BSPP	303 stainless	2.87	72.9	1.79	45.5	1-5/8"

Interchange Data

- Interchangeable with Oasis 300 Series

Materials

- Machined components are manufactured using 303 stainless steel bar stock
- Stainless steel springs and retaining rings maximize corrosion resistance and extend service life
- Latches are manufactured from high strength 17-7 stainless steel

Seal Components

- Nitrile seals are standard, providing a temperature range of **-65°F to 180°F (-65°C to 82°C)**
- Coupler has redundant O-ring sealing system with PTFE backup ring
- Valve has captured O-ring to maintain integrity during excessive flow conditions and pressurized connections

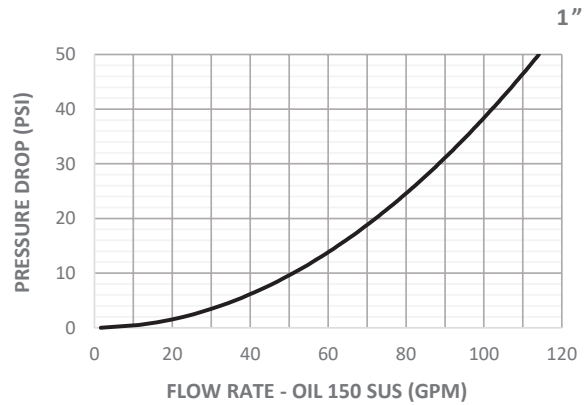

Rated Pressure Chart

Body Size	CNG-Series Oasis Interchange			
	303 Stainless Steel Coupler/Plug			
	Maximum Working		Burst	
	PSI	Bar	PSI	Bar
1"	5,000	345	18,500	1,275

Technical Specifications

Body Size	Interchange Standards				Functional Parameters			
	U.S. Military	U.S. Government	International Standards	ANSI/NFPA Standards	Air Inclusion	Fluid Loss	Vacuum Rating	Flow ΔP = 15 PSI
1"	-	-	-	-	N/A	N/A	N/R	76 GPM ¹

¹Flow calculated with CV value with water testing

Hydraulic Couplings: CNG-Series

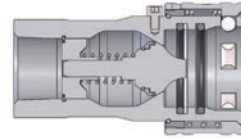
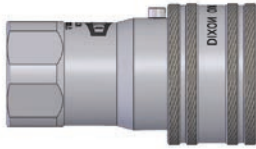

Body Size	CNG-Series Compressed Natural Gas Coupler (Female Threads)							
	Part Detail			Length		Maximum O.D.		Hex Inch
	Part #	Threads	Material	Inch	mm	Inch	mm	
1"	8CNGF8-S	1" – 11-1/2 NPTF	303 SS	4.30	109.22	2.53	64.26	1-7/8"

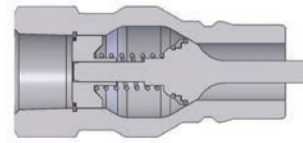

Body Size	CNG-Series Compressed Natural Gas Plug (Female Threads)							
	Part Detail			Length		Maximum O.D.		Hex Inch
	Part #	Threads	Material	Inch	mm	Inch	mm	
1"	CNG8F8-S	1" – 11-1/2 NPTF	303 SS	4.72	119.88	2.06	52.32	1-7/8"

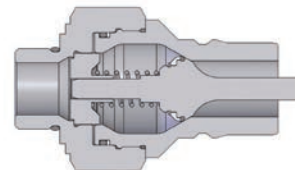
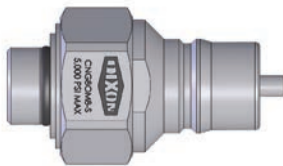

Body Size	CNG-Series Compressed Natural Gas Plug (Male Threads)							
	Part Detail			Length		Maximum O.D.		Hex Inch
	Part #	Threads	Material	Inch	mm	Inch	mm	
1"	CNG80M8-S	1-5/16" – 12 ORB	303 SS	4.70	119.38	2.66	67.57	2-3/8"

Interchange Data

- Interchangeable to ISO7241 Series A
- Parker 6600-Series and Eaton/Aeroquip FD56 (5600)
- Faster ANV and Safeway S56-Series

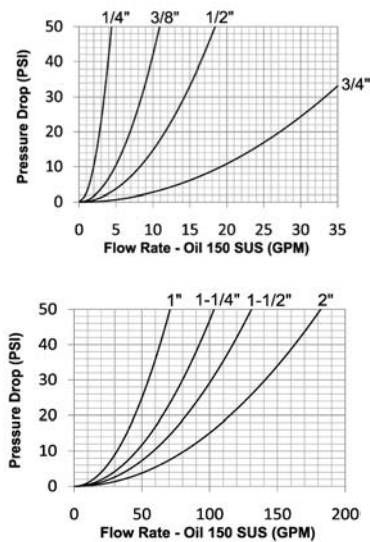

Materials

- Machined components are manufactured using solid steel bar stock or 316 stainless steel bar stock
- Stainless steel balls, retaining rings, and springs maximize corrosion resistance and extend service life
- Steel componentry is plated using ROHS-compliant trivalent chrome
- Steel coupler sleeves are hardened to resist deformation and maximize service life
- Steel plugs are hardened to provide heavy-duty performance and resist brinelling

Seal Components

- Nitrile seals are standard, providing a temperature range of **-40°F to 250°F (-40°C to 121°C)**
- Couplers have a PTFE anti-extrusion ring
- Valve seals are crimped in place to maintain integrity during excessive flow conditions and pressurized connection

Rated Pressure Chart

Body Size	K-Series ISO-A Interchange (Connected)							
	Steel Coupler/Plug							
	Maximum Working				Burst			
	Steel PSI	Steel Bar	316 Stainless Steel PSI	316 Stainless Steel Bar	Steel PSI	Steel Bar	316 Stainless Steel PSI	316 Stainless Steel Bar
1/4"	5,000	345	4,500	300	18,270	1,200	30,500	2,100
3/8"	4,000	275	3,750	250	16,000	1,100	16,000	1,100
1/2"	4,000	275	3,750	250	16,500	1,100	18,000	1,200
3/4"	4,000	275	3,000	200	14,800	1,000	12,000	800
1"	4,000	275	3,000	200	12,400	850	12,000	800
1-1/4"	3,000	200	-	-	12,600	850	-	-
1-1/2"	3,000	200	-	-	12,600	850	-	-
2"	1,450	100	-	-	5,800	400	-	-

Technical Specifications

Body Size	Interchange Standards				Functional Parameters				
	U.S. Military	U.S. Government	International Standards	ANSI/NFPA Standards	Locking Ball Quantity	Air Inclusion	Fluid Loss	Vacuum Inch HG	Flow ΔP = 22 PSI
1/4"	-	-	ISO7241 A	-	6	0.6cc	0.3cc	26.5	2.9 GPM
3/8"	-	-	ISO7241 A	-	9	2.6cc	1.8cc	26.5	7 GPM
1/2"	-	-	ISO7241 A	-	9	3.8cc	2.9cc	26.5	12 GPM
3/4"	-	-	ISO7241 A	-	12	10.8cc	9.7cc	26.5	28 GPM
1"	-	-	ISO7241 A	-	15	15.9cc	15.3cc	26.5	50 GPM
1-1/4"	-	-	ISO7241 A	-	16	31.7cc	29.1cc	26.5	70 GPM
1-1/2"	-	-	ISO7241 A	-	16	56.4cc	52.2cc	26.5	90 GPM
2"	-	-	ISO7241 A	-	15	N/A	N/A	26.5	120 GPM

Available Options

Body Size	Standard Seal Options						Kalrez® Seal Options		
	FKM	EPDM	FDA FKM	Mil-Nitrile	Fuel Nitrile	Silicone	4079	6375	7075
1/4"	F-	P-	D-	M-	JF-	S-	K4-	K6-	K7-
3/8"	F-	P-	D-	M-	JF-	S-	K4-	K6-	K7-
1/2"	F-	P-	D-	M-	JF-	S-	K4-	K6-	K7-
3/4"	F-	P-	D-	M-	JF-	S-	K4-	K6-	K7-
1"	F-	P-	D-	M-	JF-	S-	K4-	K6-	K7-
1-1/4"	N/A	N/A	N/A	N/A	N/A	N/A	N/A	N/A	N/A
1-1/2"	N/A	N/A	N/A	N/A	N/A	N/A	N/A	N/A	N/A
2"	N/A	N/A	N/A	N/A	N/A	N/A	N/A	N/A	N/A

Body Size	Valve Options						Sleeve	Treatments
	Unvalved	Actuator ¹	Steel	Brass	303 SS	316 SS	Locking	Oxy-Clean
1/4"	-E	N/A	-ZV	-BV	N/A	N/A	-LS	-C1
3/8"	-E	-VA	-ZV	-BV	-SV	SSV	-LS	-C1
1/2"	-E	-VA	-ZV	-BV	-SV	SSV	-LS	-C1
3/4"	-E	-VA	-ZV	-BV	-SV	SSV	-LS	-C1
1"	-E	-VA	-ZV	-BV	-SV	SSV	-LS	-C1
1-1/4"	N/A	N/A	-ZV	N/A	N/A	N/A	N/A	N/A
1-1/2"	N/A	N/A	-ZV	N/A	N/A	N/A	N/A	N/A
2"	N/A	N/A	-ZV	N/A	N/A	N/A	N/A	N/A

¹Brass valve actuator

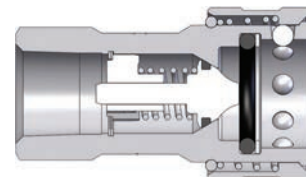
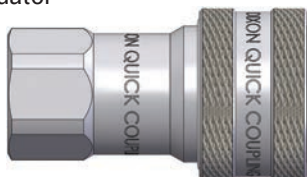

Body Size	K-Series ISO-A Interchange Coupler (Female Threads)							
	Part Detail			Length		Maximum O.D.		Hex Inch
	Part #	Threads	Material	Inch	mm	Inch	mm	
1/4"	2KF1	1/8" - 27 NPTF	steel	1.89	47.9	1.00	25.4	3/4"
	2KF2	1/4" - 18 NPTF	steel	1.89	47.9	1.00	25.4	3/4"
	2KF2-SS	1/4" - 18 NPTF	316 stainless	1.89	47.9	1.00	25.4	3/4"
	2KBF2	1/4" - 19 BSPP	steel	1.89	47.9	1.00	25.4	3/4"
	2KBF2-SS	1/4" - 19 BSPP	316 stainless	1.89	47.9	1.00	25.4	3/4"
	2KOF2	7/16" - 20 ORB	steel	1.89	47.9	1.00	25.4	3/4"
3/8"	3KF3	3/8" - 18 NPTF	steel	2.23	56.5	1.19	30.2	7/8"
	3KF3-SS	3/8" - 18 NPTF	316 stainless	2.23	56.5	1.19	30.2	7/8"
	3KBF3	3/8" - 19 BSPP	steel	2.23	56.6	1.19	30.2	7/8"
	3KBF3-SS	3/8" - 19 BSPP	316 stainless	2.23	56.6	1.19	30.2	7/8"
	3KOF3	9/16" - 18 ORB	steel	2.23	56.6	1.19	30.2	7/8"
1/2"	4KF4	1/2" - 14 NPTF	steel	2.62	66.5	1.49	37.8	1-1/16"
	4KF4-SS	1/2" - 14 NPTF	316 stainless	2.62	66.5	1.49	37.8	1-1/16"
	4KBF4	1/2" - 14 BSPP	steel	2.62	66.5	1.49	37.8	1-1/16"
	4KBF4-SS	1/2" - 14 BSPP	316 stainless	2.62	66.5	1.49	37.8	1-1/16"
	4KOF4	3/4" - 16 ORB	steel	2.62	66.5	1.49	37.8	1-1/16"
	4KOF5	7/8" - 14 ORB	steel	2.66	67.6	1.49	37.8	1-3/32"
	4KF6	3/4" - 14 NPTF	steel	2.64	66.9	1.49	37.8	1-5/16"

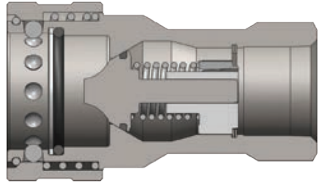

Body Size	K-Series ISO-A Interchange Coupler (Female Threads)							
	Part Detail			Length		Maximum O.D.		Hex Inch
	Part #	Threads	Material	Inch	mm	Inch	mm	
3/4"	6KF6	3/4" - 14 NPTF	steel	3.23	82.0	1.86	47.2	1-5/16"
	6KF6-SS	3/4" - 14 NPTF	316 stainless	3.23	82.0	1.86	47.2	1-5/16"
	6KBF6	3/4" - 14 BSPP	steel	3.23	82.0	1.86	47.2	1-5/16"
	6KBF6-SS	3/4" - 14 BSPP	316 stainless	3.23	82.0	1.86	47.2	1-5/16"
	6KOF6	1-1/16" - 12 ORB	steel	3.23	82.0	1.86	47.2	1-5/16"
1"	8KF8	1" - 11-1/2 NPTF	steel	3.88	98.6	2.10	53.3	1-5/8"
	8KF8-SS	1" - 11-1/2 NPTF	316 stainless	3.88	98.6	2.10	53.3	1-5/8"
	8KBF8	1" - 11 BSPP	steel	3.88	98.6	2.10	53.3	1-5/8"
	8KBF8-SS	1" - 11 BSPP	316 stainless	3.88	98.6	2.10	53.3	1-5/8"
	8KOF8	1-5/16" - 12 ORB	steel	3.88	98.6	2.10	53.3	1-5/8"

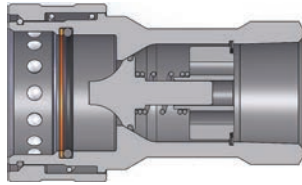

Body Size	K-Series ISO-A Interchange Coupler (Female Threads)							
	Part Detail			Length		Maximum O.D.		Hex Inch
	Part #	Threads	Material	Inch	mm	Inch	mm	
1-1/4"	10KF10	1-1/4" - 11-1/2 NPT	steel	4.61	117.0	2.76	70.0	2"
	10KBF10	1-1/4" - 11 BSPP	steel	4.61	117.0	2.76	70.0	2"
1-1/2"	12KF12	1-1/2" - 11-1/2 NPT	steel	5.24	133.0	3.33	84.5	2-3/8"
	12KBF12	1-1/2" - 11 BSPP	steel	5.24	133.0	3.33	84.5	2-3/8"
2"	16KF16	2" - 11-1/2 NPT	steel	6.50	165.0	3.94	100.0	3"
	16KBF16	2" - 11 BSPP	steel	6.50	165.0	3.94	100.0	3"

Body Size	A	B
1/4"	0.46	0.17
3/8"	0.68	0.29
1/2"	0.81	0.37
3/4"	1.14	0.55
1"	1.35	0.66
1-1/4"	1.77	0.98
1-1/2"	2.16	1.21
2"	2.56	1.38

K Profiles

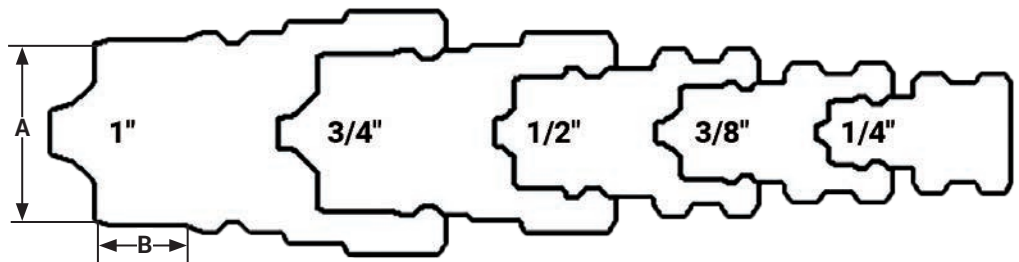

Hydraulic Couplings: K-Series

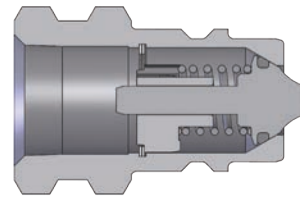
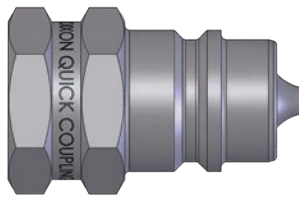

Body Size	K-Series ISO-A Interchange Plug (Female Threads)							
	Part Detail			Length		Maximum O.D.		Hex Inch
	Part #	Threads	Material	Inch	mm	Inch	mm	
1/4"	K2F1	1/8" - 27 NPTF	steel	1.22	31.0	0.87	22.1	3/4"
	K2F2	1/4" - 18 NPTF	steel	1.22	31.0	0.87	22.1	3/4"
	K2F2-SS	1/4" - 18 NPTF	316 stainless	1.22	31.0	0.87	22.1	3/4"
	K2BF2	1/4" - 19 BSPP	steel	1.22	31.0	0.87	22.1	3/4"
	K2BF2-SS	1/4" - 19 BSPP	316 stainless	1.22	31.0	0.87	22.1	3/4"
	K2OF2	7/16" - 20 ORB	steel	1.22	31.0	0.87	22.1	3/4"
3/8"	K3F3	3/8" - 18 NPTF	steel	1.70	43.2	0.97	24.6	7/8"
	K3F3-SS	3/8" - 18 NPTF	316 stainless	1.70	43.2	0.97	24.6	7/8"
	K3BF3	3/8" - 19 BSPP	steel	1.70	43.2	0.97	24.6	7/8"
	K3BF3-SS	3/8" - 19 BSPP	316 stainless	1.70	43.2	0.97	24.6	7/8"
	K3OF3	9/16" - 18 ORB	steel	1.70	43.2	0.97	24.6	7/8"
1/2"	K4F4	1/2" - 14 NPTF	steel	1.77	45.0	1.23	31.2	1-1/16"
	K4F4-SS	1/2" - 14 NPTF	316 stainless	1.77	45.0	1.23	31.2	1-1/16"
	K4BF4	1/2" - 14 BSPP	steel	1.77	45.0	1.23	31.2	1-1/16"
	K4BF4-SS	1/2" - 14 BSPP	316 stainless	1.77	45.0	1.23	31.2	1-1/16"
	K4OF4	3/4" - 16 ORB	steel	1.77	45.0	1.23	31.2	1-1/16"
	K4OF5	7/8" - 14 ORB	steel	1.77	45.0	1.23	31.2	1-1/16"
	K4F6	3/4" - 14 NPTF	steel	1.77	45.0	1.37	34.8	1-3/16"

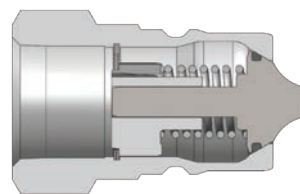
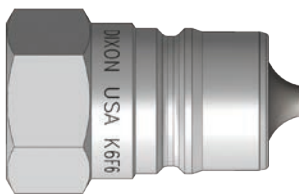

Body Size	K-Series ISO-A Interchange Plug (Female Threads)							
	Part Detail			Length		Maximum O.D.		Hex Inch
	Part #	Threads	Material	Inch	mm	Inch	mm	
3/4"	K6F6	3/4" - 14 NPTF	steel	2.43	61.7	1.44	36.6	1-5/16"
	K6F6-SS	3/4" - 14 NPTF	316 stainless	2.43	61.7	1.44	36.6	1-5/16"
	K6BF6	3/4" - 14 BSPP	steel	2.43	61.7	1.44	36.6	1-5/16"
	K6BF6-SS	3/4" - 14 BSPP	316 stainless	2.43	61.7	1.44	36.6	1-5/16"
	K6OF6	1-1/16" - 12 ORB	steel	2.43	61.7	1.44	36.6	1-5/16"
1"	K8F8	1" - 11-1/2 NPTF	steel	2.87	72.9	1.79	45.5	1-5/8"
	K8F8-SS	1" - 11-1/2 NPTF	316 stainless	2.87	72.9	1.79	45.5	1-5/8"
	K8BF8	1" - 11 BSPP	steel	2.87	72.9	1.79	45.5	1-5/8"
	K8BF8-SS	1" - 11 BSPP	316 stainless	2.87	72.9	1.79	45.5	1-5/8"
	K8OF8	1-5/16" - 12 ORB	steel	2.87	72.9	1.79	45.5	1-5/8"
1-1/4"	K10F10	1-1/4" - 11-1/2 NPT	steel	2.95	75.0	2.31	58.7	2"
	K10BF10	1-1/4" - 11 BSPP	steel	2.95	75.0	2.31	58.7	2"
1-1/2"	K12F12	1-1/2" - 11-1/2 NPT	steel	3.29	83.5	2.74	69.6	2-3/8"
	K12BF12	1-1/2" - 11 BSPP	steel	3.29	83.5	2.74	69.6	2-3/8"
2"	K16F16	2" - 11-1/2 NPT	steel	4.13	105.0	3.46	87.9	3"
	K16BF16	2" - 11 BSPP	steel	4.13	105.0	3.46	87.9	3"



Body Size	K-Series ISO-A Interchange Combination Dust Cap and Plug		
	Part Detail		
	Combination dust plug and cap		Material
1/4"	2KDP-K2DC		Nitrile
3/8"	3KDP-K3DC		Nitrile
1/2"	see below		
3/4"	6KDP-K6DC		Nitrile
1"	8KDP-K8DC		Nitrile



Body Size	K-Series ISO-A Interchange Color-Coded Dust Plug		
	Part Detail		
	Part #	Color	Material
1/2"	4KDP	black	Nitrile
	4K-R-DP	red	Nitrile
	4K-O-DP	orange	Nitrile
	4K-Y-DP	yellow	Nitrile
	4K-G-DP	green	Nitrile
	4K-B-DP	blue	Nitrile



Body Size	K-Series ISO-A Interchange Color-Coded Dust Cap		
	Part Detail		
	Part #	Color	Material
1/2"	K4DC	black	Nitrile
	K4-R-DC	red	Nitrile
	K4-O-DC	orange	Nitrile
	K4-Y-DC	yellow	Nitrile
	K4-G-DC	green	Nitrile
	K4-B-DC	blue	Nitrile

Hydraulic Couplings: K-Series

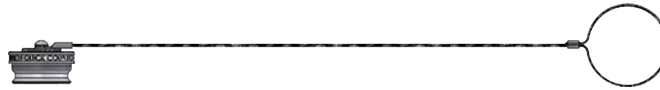

Body Size	K-Series ISO-A-Series Dust Plug		
	Part Detail		
	Part #	Lanyard	Body
1-1/4"	10KDP-A	steel cable	aluminum
1-1/2"	12KDP-A	steel cable	aluminum
2"	16KDP-A	steel cable	aluminum

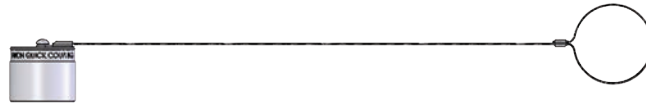

Body Size	K-Series ISO-A-Series Dust Cap		
	Part Detail		
	Part #	Lanyard	Body
1-1/4"	K10DC-A	steel cable	aluminum
1-1/2"	K12DC-A	steel cable	aluminum
2"	K16DC-A	steel cable	aluminum

Body Size	K-Series ISO-A Coupler Seal Kits			
	Part Detail			Seal Kit Contents
	Part #	Coupler Style	Seal Material	
1/4"	2K-SKIT	all	Nitrile	O-ring and PTFE anti-extrusion ring
3/8"	3K-SKIT	all	Nitrile	O-ring and PTFE anti-extrusion ring
1/2"	4K-SKIT	all	Nitrile	O-ring and PTFE anti-extrusion ring
3/4"	6K-SKIT	all	Nitrile	O-ring and PTFE anti-extrusion ring
1"	8K-SKIT	all	Nitrile	O-ring and PTFE anti-extrusion ring
1-1/4"	10K-SKIT	all	Nitrile	O-ring and PTFE anti-extrusion ring
1-1/2"	12K-SKIT	all	Nitrile	O-ring and PTFE anti-extrusion ring
2"	16K-SKIT	all	Nitrile	O-ring and PTFE anti-extrusion ring

Interchange Data

- Agricultural Interchange
- Parker/Pioneer 4000 Series and Faster NS/NV-Series
- Safeway Series-S20 and Stucchi IR-Series

Materials

- Machined components are manufactured using solid steel bar stock
- Stainless steel balls, retaining rings, and springs maximize corrosion resistance and extend service life
- Steel componentry is plated using ROHS-compliant trivalent chrome
- Steel coupler sleeves are hardened to resist deformation and maximize service life
- Steel plugs are hardened to provide heavy-duty performance and resist brinelling

Seal Components

- Nitrile seals are standard, providing a temperature range of **-40°F to 250°F (-40°C to 121°C)**
- Couplers have a PTFE anti-extrusion ring
- Poppet valve seals are crimped in place to maintain integrity during excessive flow conditions and pressurized connection

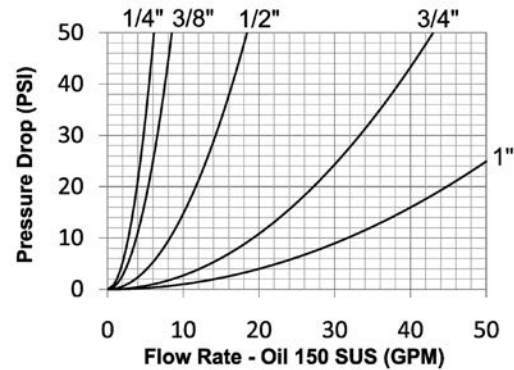

Rated Pressure Chart

Body Size	AG-Series Agricultural Interchange (Connected)							
	Ball Steel Coupler/Plug				Poppet Steel Coupler/Plug			
	Maximum Working		Burst		Maximum Working		Burst	
	PSI	Bar	PSI	Bar	PSI	Bar	PSI	Bar
1/4"	4,000	275	24,400	1,700	4,000	275	21,000	1,500
3/8"	4,000	275	25,000	1,700	4,000	275	16,100	1,100
1/2"	4,000	275	16,500	1,100	4,000	275	16,500	1,100
3/4"	3,000	200	15,800	1,050	3,000	200	10,300	700
1"	3,000	200	13,500	900	3,000	200	13,000	900

Technical Specifications

Body Size	Interchange Standards				Functional Parameters				
	U.S. Military	U.S. Government	International Standards	ANSI/NFPA Standards	Locking Ball Quantity	Air Inclusion	Fluid Loss	Vacuum Inch HG	Flow $\Delta P = 22$ PSI
1/4"	-	-	-	-	8	1.1cc	0.9cc	26.5	4 GPM
3/8"	-	-	-	-	9	2.6cc	1.8cc	26.5	6 GPM
1/2"	-	-	ISO7241 A	-	9	3.8cc	2.9cc	26.5	12 GPM
3/4"	-	-	ISO5675	-	12	10.8cc	9.7cc	26.5	28 GPM
1"	-	-	-	-	12	15.9cc	15.3cc	26.5	48 GPM

AG Series Profiles

Body Size	A	B
1/4"	0.56	0.31
3/8"	0.74	0.35
1/2"	0.81	0.37
3/4"	1.06	0.50
1"	1.23	0.62

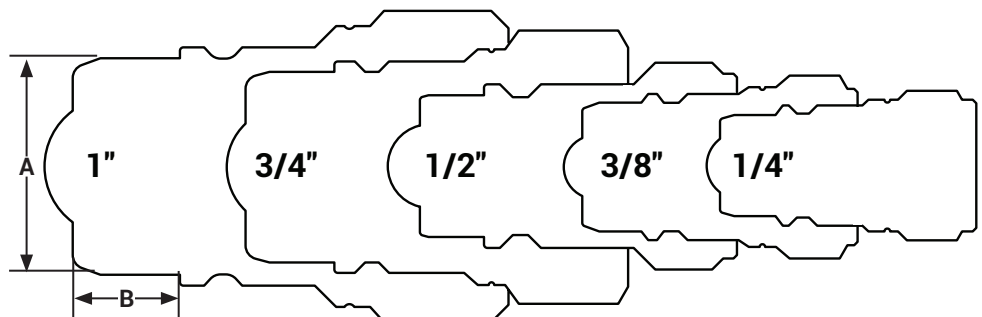

Hydraulic Couplings: AG-Series

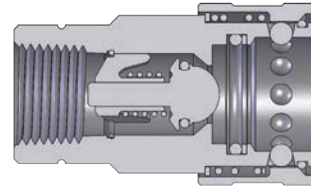
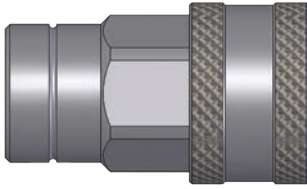

Body Size	AG-Series Agricultural Interchange Ball Valve Coupler (Female Threads)							
	Part Detail			Length		Maximum O.D.		Hex Inch
	Part #	Threads	Material	Inch	mm	Inch	mm	
1/4"	2AGF2	1/4" - 18 NPTF	steel	2.06	52.3	1.12	28.4	7/8"
3/8"	3AGF3	3/8" - 18 NPTF	steel	2.31	58.6	1.42	36.0	7/8"
1/2"	4AGF4	1/2" - 14 NPTF	steel	2.62	66.5	1.50	38.1	1-1/16"
	4AGBF4	1/2" - 14 BSPP	steel	2.62	66.5	1.50	38.1	1-1/16"
	4AGOF4	3/4" - 16 ORB	steel	2.62	66.5	1.50	38.1	1-1/16"
	4AGOF5	7/8" - 14 ORB	steel	2.66	67.5	1.50	38.1	1-3/32"
	4AGF6	3/4" - 14 NPTF	steel	2.64	67.0	1.50	38.1	1-5/16"
3/4"	6AGF6	3/4" - 14 NPTF	steel	3.23	82.0	1.88	47.7	1-5/16"
1"	8AGF8	1" - 11-1/2 NPTF	steel	3.79	96.2	2.12	53.8	1-5/8"

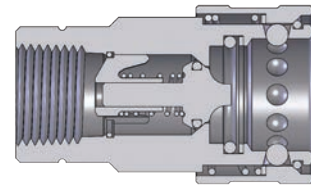
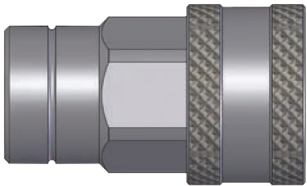

Body Size	AG-Series Agricultural Interchange Poppet Valve Coupler (Female Threads)							
	Part Detail			Length		Maximum O.D.		Hex Inch
	Part #	Threads	Material	Inch	mm	Inch	mm	
1/4"	2AGF2-PV	1/4" - 18 NPTF	steel	2.06	52.3	1.12	27.0	7/8"
3/8"	3AGF3-PV	3/8" - 18 NPTF	steel	2.31	58.6	1.42	34.0	7/8"
1/2"	4AGF4-PV	1/2" - 14 NPTF	steel	2.62	66.5	1.50	37.8	1-1/16"
	4AGBF4-PV	1/2" - 14 BSPP	steel	2.62	66.5	1.50	37.8	1-1/16"
	4AGOF4-PV	3/4" - 16 ORB	steel	2.62	66.5	1.50	37.8	1-1/16"
	4AGOF5-PV	7/8" - 14 ORB	steel	2.66	67.5	1.50	37.8	1-3/32"
	4AGF6-PV	3/4" - 14 NPTF	steel	2.64	67.0	1.50	37.8	1-5/16"
3/4"	6AGF6-PV	3/4" - 14 NPTF	steel	3.23	82.0	1.88	48.0	1-5/16"
1"	8AGF8-PV	1" - 11-1/2 NPTF	steel	3.79	96.2	2.12	55.0	1-5/8"

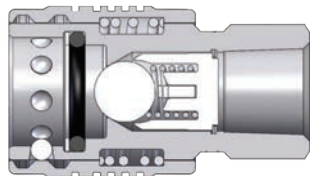

Body Size	AG-Series Agricultural Interchange Push-Pull Ball Valve Coupler (Female Threads)							
	Part Detail			Length		Maximum O.D.		Hex Inch
	Part #	Threads	Material	Inch	mm	Inch	mm	
3/8"	3AGF3-PS	3/8" - 18 NPTF	steel	2.31	58.6	1.42	36.07	7/8"
1/2"	4AGF4-PS	1/2" - 14 NPTF	steel	2.62	66.5	1.49	37.8	1-1/16"
	4AGOF4-PS	3/4" - 16 ORB	steel	2.62	66.5	1.48	37.8	1-1/16"
	4AGOF5-PS	7/8" - 14 ORB	steel	2.66	67.5	1.48	37.8	1-1/16"
3/4"	4AGF6-PS	3/4" - 14 NPTF	steel	2.74	69.6	1.48	37.8	1-3/16"
	6AGF6-PS	3/4" - 14 NPTF	steel	3.23	82.0	1.86	47.2	1-3/16"

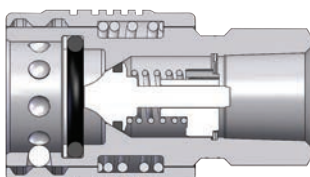

Body Size	AG-Series Agricultural Interchange Push-Pull Poppet Valve Coupler (Female Threads)							
	Part Detail			Length		Maximum O.D.		Hex Inch
	Part #	Threads	Material	Inch	mm	Inch	mm	
3/8"	3AGF3-PV-PS	3/8" - 18 NPTF	steel	2.31	58.6	1.42	36.0	7/8"
1/2"	4AGF4-PV-PS	1/2" - 14 NPTF	steel	2.62	66.5	1.49	37.8	1-1/16"
	4AGOF4-PV-PS	3/4" - 16 ORB	steel	2.62	66.5	1.49	37.8	1-1/16"
	4AGOF5-PV-PS	7/8" - 14 ORB	steel	2.66	66.5	1.49	37.8	1-1/16"
	4AGF6-PV-PS	3/4" - 14 NPTF	steel	2.74	69.6	1.49	37.8	1-3/16"
3/4"	6AGF6-PV-PS	3/4" - 14 NPTF	steel	3.23	82.0	1.86	47.2	1-3/16"

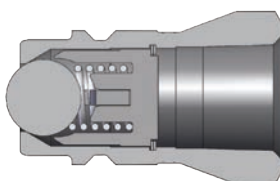

Body Size	AG-Series Agricultural Interchange Ball Valve Plug (Female Threads)							
	Part Detail			Length		Maximum O.D.		Hex Inch
	Part #	Threads	Material	Inch	mm	Inch	mm	
1/4"	AG2F2	1/4" - 18 NPTF	steel	1.42	36.0	0.84	21.3	3/4"
3/8"	AG3F3	3/8" - 18 NPTF	steel	1.61	40.8	1.05	26.6	15/16"
1/2"	AG4F4	1/2" - 14 NPTF	steel	1.95	49.5	1.21	30.7	1-1/16"
	AG4BF4	1/2" - 14 BSPP	steel	1.95	49.5	1.21	30.7	1-1/16"
	AG4OF4	3/4" - 16 ORB	steel	2.10	53.3	1.26	30.7	1-1/16"
	AG4OF5	7/8" - 14 ORB	steel	2.10	53.3	1.26	32.0	1-1/4"
	AG4F6	3/4" - 14 NPTF	steel	2.30	58.4	1.32	33.5	1-3/16"
3/4"	AG6F6	3/4" - 14 NPTF	steel	2.30	58.4	1.51	38.3	1-3/8"
1"	AG8F8	1" - 11-1/2 NPTF	steel	2.57	65.2	1.74	44.7	1-5/8"

Hydraulic Couplings: AG-Series

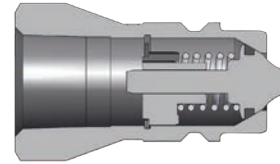

Body Size	AG-Series Agricultural Interchange Poppet Valve Plug (Female Threads)							
	Part Detail			Length		Maximum O.D.		Hex Inch
	Part #	Threads	Material	Inch	mm	Inch	mm	
1/4"	AG2F2-PV	1/4" - 18 NPTF	steel	1.42	36.0	0.84	21.3	3/4"
3/8"	AG3F3-PV	3/8" - 18 NPTF	steel	1.61	40.8	1.05	26.6	15/16"
1/2"	AG4F4-PV	1/2" - 14 NPTF	steel	2.08	52.8	1.21	30.7	1-1/16"
	AG4BF4-PV	1/2" - 14 BSPP	steel	2.08	52.8	1.21	30.7	1-1/16"
	AG4OF4-PV	3/4" - 16 ORB	steel	2.08	52.8	1.21	30.7	1-1/16"
	AG4OF5-PV	7/8" - 14 ORB	steel	2.13	54.1	1.26	32.0	1-1/16"
3/4"	AG4F6-PV	3/4" - 14 NPTF	steel	2.30	58.4	1.32	33.5	1-3/16"
1"	AG6F6-PV	3/4" - 14 NPTF	steel	2.30	58.4	1.51	38.3	1-3/8"
	AG8F8-PV	1" - 11-1/2 NPTF	steel	2.71	68.8	1.76	44.7	1-5/8"

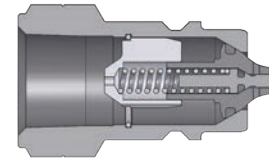
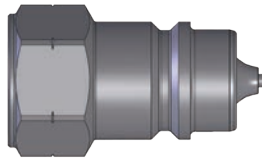

Body Size	AG-Series Agricultural Interchange Connect Under Residual Pressure Plug (Female Threads)							
	Part Detail			Length		Maximum O.D.		Hex Inch
	Part #	Threads	Material	Inch	mm	Inch	mm	
1/2"	AGE4F4-PV	1/2" - 14 NPTF	steel	2.03	51.56	1.20	30.48	1-1/16"
1/2"	AGE4OF4-PV	3/4" - 16 ORB	steel	2.03	51.56	1.20	30.48	1-1/16"



Body Size	AG-Series Agricultural Interchange Coupler Dust Plug		
	Part Detail		
	Part #	Lanyard	Body
1/4"	2AGDP	elastomer	elastomer
3/8"	3AGDP	elastomer	elastomer
1/2"	For 1/2" please refer to the color-coded K-Series dust caps on pg. 91		
3/4"	6AGDP	elastomer	elastomer
1"	8AGDP	elastomer	elastomer



Body Size	AG-Series Agricultural Interchange Plug Dust Cap		
	Part Detail		
	Part #	Lanyard	Body
1/4"	AG2DC	elastomer	elastomer
3/8"	AG3DC	elastomer	elastomer
1/2"	For 1/2" please refer to the color-coded K-Series dust caps on pg. 91		
3/4"	AG6DC	elastomer	elastomer
1"	AG8DC	elastomer	elastomer

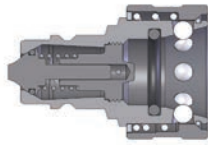

Body Size	John Deere Coupler x AG-Series Agricultural Interchange Poppet Valve Plug Adapter							
	Part Detail			Length		Maximum O.D.		Hex Inch
	Part #	Threads	Material	Inch	mm	Inch	mm	
1/2"	4JDAG4	N/A	steel	2.43	61.72	1.70	43.18	N/A

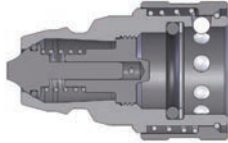

Body Size	AG-Series Agricultural Interchange Poppet Coupler X John Deere Plug Adapter							
	Part Detail			Length		Maximum O.D.		Hex Inch
	Part #	Threads	Material	Inch	mm	Inch	mm	
1/2"	4AGJD4	N/A	steel	2.38	60.45	1.49	37.85	N/A

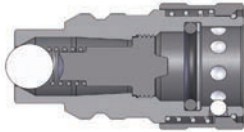

Body Size	AG-Series Agricultural Interchange Ball Valve Coupler X International Harvester Plug Adapter							
	Part Detail			Length		Maximum O.D.		Hex Inch
	Part #	Threads	Material	Inch	mm	Inch	mm	
1/2"	4AGIH4	N/A	steel	2.65	67.31	1.49	37.85	N/A

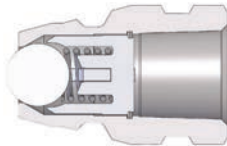

Body Size	John Deere Interchange Plug X Female Threads							
	Part Detail			Length		Maximum O.D.		Hex Inch
	Part #	Threads	Material	Inch	mm	Inch	mm	
1/2"	JD4F4	1/2" - 14 NPTF	steel	1.87	47.50	1.18	29.97	1-1/16"
1/2"	JD40F4	3/4" - 16 ORB	steel	1.87	47.50	1.18	29.97	1-1/16"



Body Size	International Harvester Interchange Plug X Female Threads							
	Part Detail			Length		Maximum O.D.		Hex Inch
	Part #	Threads	Material	Inch	mm	Inch	mm	
1/2"	IH4F4	1/2" - 14 NPTF	steel	2.75	69.85	1.25	31.75	1"

Hydraulic Couplings: V-Series

Interchange Data

- Interchangeable to MIL-C-51234
- Parker/Snap-Tite H/IH and Faster TNV/TNL

Materials

- Machined components are manufactured using solid steel, brass, or 316 stainless steel bar stock
- Stainless steel balls, retaining rings, and springs maximize corrosion resistance and extend service life
- Steel componentry is plated using ROHS-compliant trivalent chrome
- Steel coupler sleeves are hardened to resist deformation and maximize service life
- Steel plugs are machined from high-strength steel and induction hardened
- Tubular TV valves are constructed from steel bar stock and are designed for optimum performance in pneumatic applications

Seal Components

- Nitrile seals are standard, providing a temperature range of **-40°F to 250°F (-40°C to 121°C)**
- All couplers incorporate a PTFE anti-extrusion ring to protect the seal components from dynamic impulse damage
- 1/4" to 1" valve seals are crimped in place to maintain integrity during excessive flow conditions and pressurized connection
- 1-1/4" to 2" valve O-rings are retained by a unique seal-groove profile and are field replaceable

NOTE: Air flow data is presented using a coupler with a TV valve and unvalved plug. This configuration provides the optimal performance for pneumatic applications.

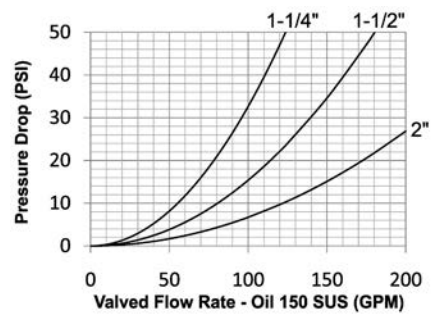
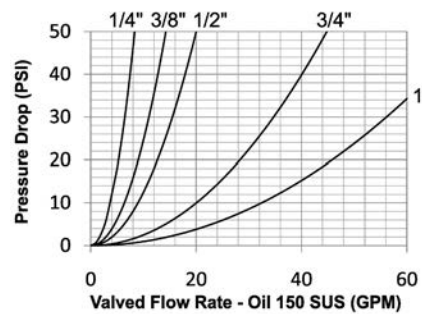
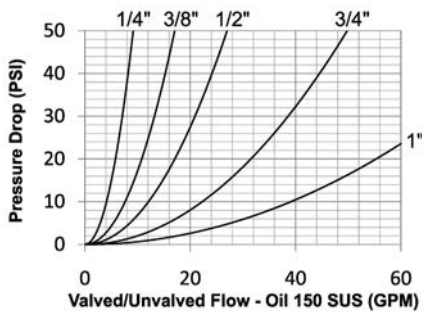
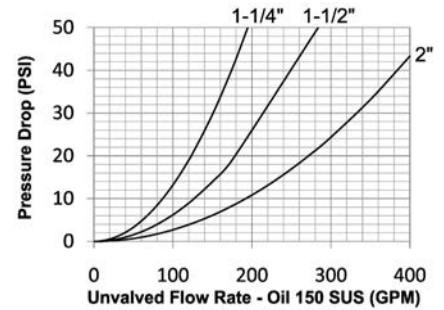
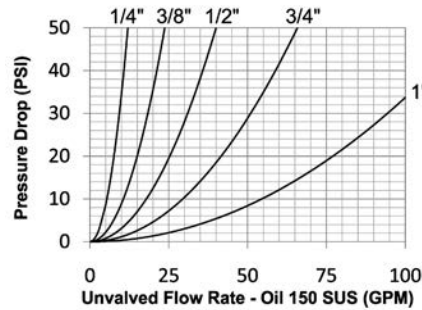
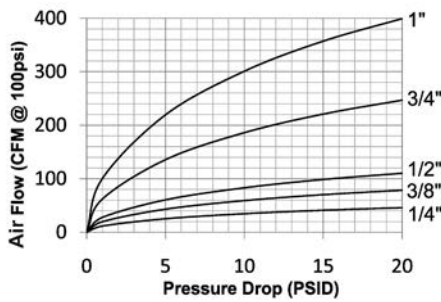

V-Series Profiles

Body Size	A	B
1/4"	0.43	0.23
3/8"	0.51	0.29
1/2"	0.63	0.29
3/4"	0.92	0.43
1"	1.17	0.41

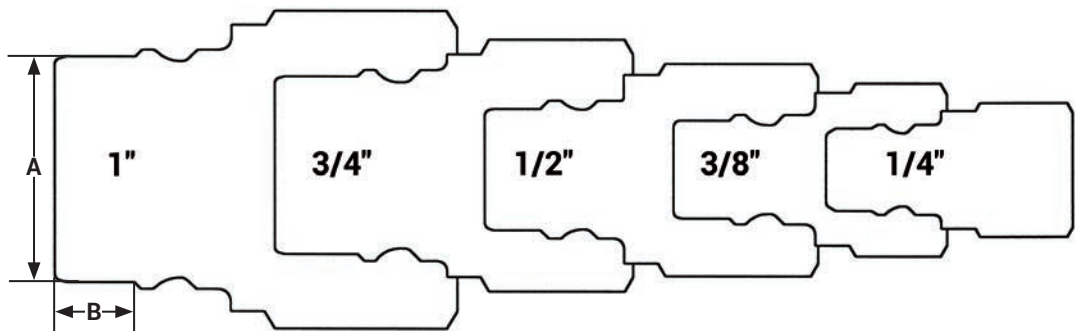

Rated Pressure Chart

Body Size	V-Series MIL-C-51234 (Valved Connected)											
	Steel Coupler/Plug				Brass Coupler/Plug				316 Stainless Coupler/Plug			
	Maximum Working		Burst		Maximum Working		Burst		Maximum Working		Burst	
	PSI	Bar	PSI	Bar	PSI	Bar	PSI	Bar	PSI	Bar	PSI	Bar
1/4"	6,500	450	12,700	876	2,250	150	5,000	345	5,000	345	10,000	700
3/8"	4,500	310	10,500	700	2,250	150	5,300	350	4,000	275	8,000	550
1/2"	4,000	275	9,600	650	2,000	130	5,700	390	3,750	260	7,500	500
3/4"	3,500	240	9,100	600	2,000	130	5,300	350	2,000	130	7,500	500
1"	2,000	130	9,500	650	1,750	120	5,000	345	2,000	130	5,000	345
1-1/4"	1,750	120	5,000	345	350	24	1,000	70	1,500	100	3,000	200
1-1/2"	1,500	100	5,000	345	350	24	1,200	80	1,500	100	3,000	200
2"	1,500	100	4,000	275	400	28	1,000	70	500	34	1,000	70

Body Size	V-Series MIL-C-51234 (Unvalved Connected)											
	Steel Coupler/Plug				Brass Coupler/Plug				316 SS Coupler/Plug			
	Maximum Working		Burst		Maximum Working		Burst		Maximum Working		Burst	
	PSI	Bar	PSI	Bar	PSI	Bar	PSI	Bar	PSI	Bar	PSI	Bar
1/4"	11,000	760	29,500	2,000	4,000	275	14,200	980	10,000	670	29,200	2,000
3/8"	11,000	760	29,900	2,000	4,000	275	14,500	1,000	8,000	550	27,900	1,900
1/2"	11,000	760	29,300	2,000	4,000	275	14,500	1,000	8,000	550	24,600	1,700
3/4"	9,000	620	19,300	1,300	3,500	250	11,100	750	7,000	480	22,600	1,500
1"	6,000	400	15,900	1,100	3,000	200	8,200	560	4,000	275	15,500	1,000
1-1/4"	5,000	345	10,000	700	1,000	70	4,000	275	3,000	200	10,000	700
1-1/2"	5,000	345	10,000	700	1,000	70	4,000	275	3,000	200	10,000	700
2"	4,000	275	8,000	550	750	50	2,800	190	1,000	70	6,000	400

Technical Specifications

Body Size	Interchange Standards			Functional Parameters				
	U.S. Military	International Standards	ANSI/NFPA Standards	Locking Ball Quantity	Air Inclusion	Fluid Loss	Vacuum inch HG	Flow ΔP = 22 PSI
1/4"	MIL-C-51234	-	-	6	2.0cc	0.2cc	26.7	5.5 GPM
3/8"	MIL-C-51234	-	-	6	3.5cc	3.2cc	26.7	9.5 GPM
1/2"	MIL-C-51234	-	-	9	4.0cc	4.0cc	26.7	13.0 GPM
3/4"	MIL-C-51234	-	-	9	14.0cc	14.0cc	26.7	30.0 GPM
1"	MIL-C-51234	-	-	12	21.0cc	20.0cc	26.7	48.0 GPM
1-1/4"	MIL-C-51234	-	-	12	45.0cc	45.0cc	N/R	82.0 GPM
1-1/2"	MIL-C-51234	-	-	12	80.0cc	80.0cc	N/R	120.0 GPM
2"	MIL-C-51234	-	-	12	150.0cc	150.0cc	N/R	185.0 GPM

Available Options

Body Size	Standard Seal Options							Kalrez® Seal Options		
	FKM	EPDM	Steam-EP	FDA FKM	Mil-Nitrile	Fuel Nitrile	Silicone	4079	6375	7075
1/4"	F-	P-	PS-	D-	M-	JF-	S-	K4-	K6-	K7-
3/8"	F-	P-	PS-	D-	M-	JF-	S-	K4-	K6-	K7-
1/2"	F-	P-	PS-	D-	M-	JF-	S-	K4-	K6-	K7-
3/4"	F-	P-	PS-	D-	M-	JF-	S-	K4-	K6-	K7-
1"	F-	P-	PS-	D-	M-	JF-	S-	K4-	K6-	K7-
1-1/4"	F-	P-	PS-	D-	M-	JF-	S-	K4-	K6-	K7-
1-1/2"	F-	P-	PS-	D-	M-	JF-	S-	K4-	K6-	K7-
2"	F-	P-	PS-	D-	M-	JF-	S-	K4-	K6-	K7-

Body Size	Valve Options					Sleeve Options			Treatments
	Unvalved	Tubular	Steel	Brass	316 SS	Sleeve-Lock	Flanged	Sil-Flange	Oxy-Clean
1/4"	-E	-TV	-ZV	-BV	SSV	-LS	N/A	N/A	-C1
3/8"	-E	-TV	-ZV	-BV	SSV	-LS	N/A	N/A	-C1
1/2"	-E	-TV	-ZV	-BV	SSV	-LS	N/A	N/A	-C1
3/4"	-E	-TV	-ZV	-BV	SSV	-LS	N/A	N/A	-C1
1"	-E	-TV	-ZV	-BV	SSV	-LS	N/A	N/A	-C1
1-1/4"	-E		-ZV	-BV	SSV	-LS	N/A	N/A	-C1
1-1/2"	-E		-ZV	-BV	SSV	-LS	N/A	N/A	-C1
2"	-E		-ZV	-BV	SSV	-LS	N/A	N/A	-C1

Large V-Series Profiles

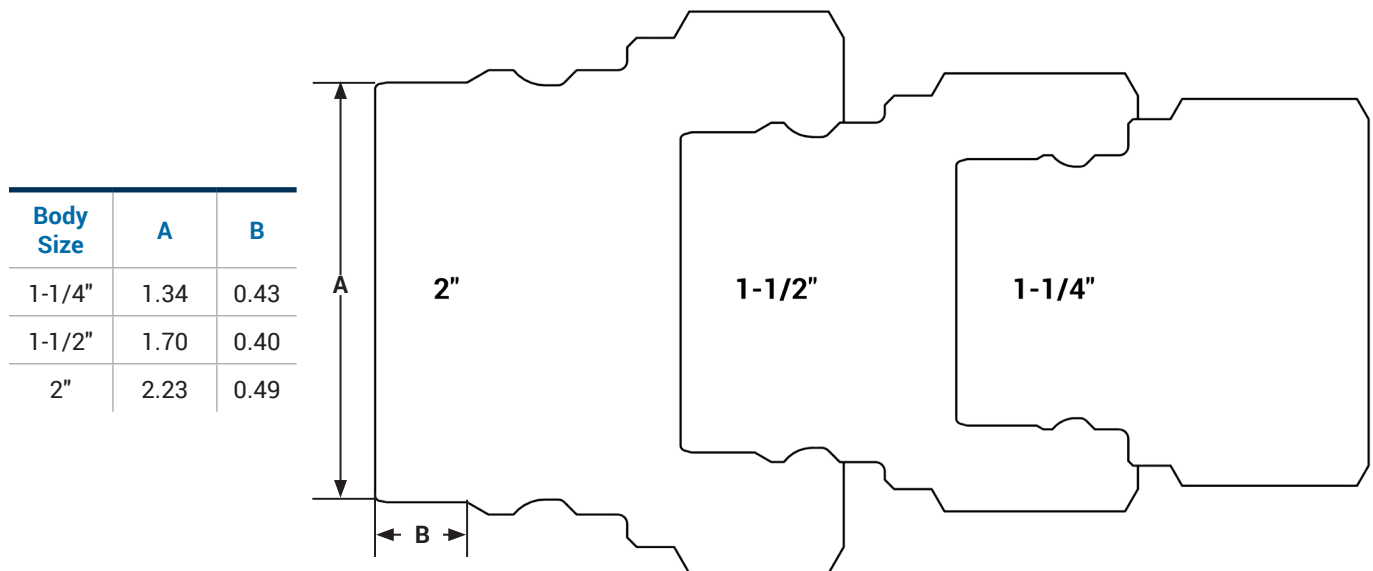

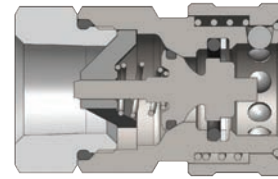
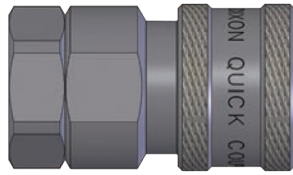

Body Size	V-Series MIL-C-51234 Valved Coupler (Female Threads)							
	Part Detail			Length		Maximum O.D.		Hex inch
	Part #	Threads	Material	inch	mm	inch	mm	
1/4"	2VF1	1/8" - 27 NPTF	steel	1.68	42.7	0.99	25.1	7/8"
	2VF2	1/4" - 18 NPTF	steel	1.68	42.7	0.99	25.1	7/8"
	2VF2-B	1/4" - 18 NPTF	brass	1.68	42.7	0.99	25.1	7/8"
	2VF2-SS	1/4" - 18 NPTF	316 stainless	1.68	42.7	0.99	25.1	7/8"
	2VBF2	1/4" - 19 BSPP	steel	1.81	46.0	0.99	25.1	7/8"
	2VBF2-B	1/4" - 19 BSPP	brass	1.81	46.0	0.99	25.1	7/8"
	2VBF2-SS	1/4" - 19 BSPP	316 stainless	1.81	46.0	0.99	25.1	7/8"
	2VOF2	7/16" - 20 ORB	steel	1.81	46.0	0.99	25.1	7/8"
3/8"	3VF3	3/8" - 18 NPTF	steel	1.94	49.3	1.18	30.0	1"
	3VF3-B	3/8" - 18 NPTF	brass	1.94	49.3	1.18	30.0	1"
	3VF3-SS	3/8" - 18 NPTF	316 stainless	1.94	49.3	1.18	30.0	1"
	3VBF3	3/8" - 19 BSPP	steel	2.01	51.1	1.18	30.0	1"
	3VBF3-B	3/8" - 19 BSPP	brass	2.01	51.1	1.18	30.0	1"
	3VBF3-SS	3/8" - 19 BSPP	316 stainless	2.01	51.1	1.18	30.0	1"
		3VOF3	9/16" - 18 ORB	steel	2.01	51.1	1.18	30.0
	3VF4	1/2" - 14 NPTF	steel	2.01	51.1	1.18	30.0	1"
1/2"	4VF4	1/2" - 14 NPTF	steel	2.13	54.1	1.36	34.5	1-3/16"
	4VF4-B	1/2" - 14 NPTF	brass	2.13	54.1	1.36	34.5	1-3/16"
	4VF4-SS	1/2" - 14 NPTF	316 stainless	2.13	54.1	1.36	34.5	1-3/16"
	4VBF4	1/2" - 14 BSPP	steel	2.13	54.1	1.36	34.5	1-3/16"
	4VBF4-B	1/2" - 14 BSPP	brass	2.13	54.1	1.36	34.5	1-3/16"
	4VBF4-SS	1/2" - 14 BSPP	316 stainless	2.13	54.1	1.36	34.5	1-3/16"
		4VOF4	3/4" - 16 ORB	steel	2.13	54.1	1.36	34.5
	4VF6	3/4" - 14 NPTF	steel	2.13	54.1	1.36	34.5	1-3/16"
3/4"	6VF6	3/4" - 14 NPTF	steel	2.47	62.7	1.67	42.4	1-1/2"
	6VF6-B	3/4" - 14 NPTF	brass	2.47	62.7	1.67	42.4	1-1/2"
	6VF6-SS	3/4" - 14 NPTF	316 stainless	2.47	62.7	1.67	42.4	1-1/2"
	6VBF6	3/4" - 14 BSPP	steel	2.96	75.2	1.67	42.4	1-1/2"
	6VBF6-B	3/4" - 14 BSPP	brass	2.96	75.2	1.67	42.4	1-1/2"
	6VBF6-SS	3/4" - 14 BSPP	316 stainless	2.96	75.2	1.67	42.4	1-1/2"
		6VOF6	1-1/16" - 12 ORB	steel	2.96	75.2	1.67	42.4
1"	8VF8	1" - 11-1/2 NPTF	steel	2.70	68.6	2.06	52.3	1-7/8"
	8VF8-B	1" - 11-1/2 NPTF	brass	2.70	68.6	2.06	52.3	1-7/8"
	8VF8-SS	1" - 11-1/2 NPTF	316 stainless	2.70	68.6	2.06	52.3	1-7/8"
	8VBF8	1" - 11 BSPP	steel	2.97	75.4	2.06	52.3	1-7/8"
	8VBF8-B	1" - 11 BSPP	brass	2.97	75.4	2.06	52.3	1-7/8"
	8VBF8-SS	1" - 11 BSPP	316 stainless	2.97	75.4	2.06	52.3	1-7/8"
		8VOF8	1-5/16" - 12 ORB	steel	2.97	75.4	2.06	52.3

Hydraulic Couplings: V-Series

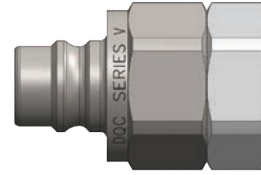
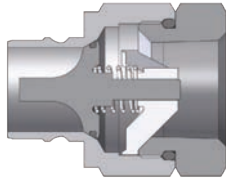

Body Size	V-Series MIL-C-51234 Valved Plug (Female Threads)							
	Part Detail			Length		Maximum O.D.		Hex inch
	Part #	Threads	Material	inch	mm	inch	mm	
1/4"	V2F1	1/8" - 27 NPTF	steel	1.62	41.1	0.97	24.6	7/8"
	V2F2	1/4" - 18 NPTF	steel	1.62	41.1	0.97	24.6	7/8"
	V2F2-B	1/4" - 18 NPTF	brass	1.62	41.1	0.97	24.6	7/8"
	V2F2-SS	1/4" - 18 NPTF	316 stainless	1.62	41.1	0.97	24.6	7/8"
	V2BF2	1/4" - 19 BSPP	steel	1.75	44.5	0.97	24.6	7/8"
	V2BF2-B	1/4" - 19 BSPP	brass	1.75	44.5	0.97	24.6	7/8"
	V2BF2-SS	1/4" - 19 BSPP	316 stainless	1.75	44.5	0.97	24.6	7/8"
	V2OF2	7/16" - 20 ORB	steel	1.75	44.5	0.97	24.6	7/8"
3/8"	V3F3	3/8" - 18 NPTF	steel	1.87	47.5	1.10	27.9	1"
	V3F3-B	3/8" - 18 NPTF	brass	1.87	47.5	1.10	27.9	1"
	V3F3-SS	3/8" - 18 NPTF	316 stainless	1.87	47.5	1.10	27.9	1"
	V3BF3	3/8" - 19 BSPP	steel	1.94	49.3	1.10	27.9	1"
	V3BF3-B	3/8" - 19 BSPP	brass	1.94	49.3	1.10	27.9	1"
	V3BF3-SS	3/8" - 19 BSPP	316 stainless	1.94	49.3	1.10	27.9	1"
	V3OF3	9/16" - 18 ORB	steel	1.94	49.3	1.10	27.9	1"
	V3F4	1/2" - 14 NPTF	steel	1.94	49.3	1.10	27.9	1"
1/2"	V4F4	1/2" - 14 NPTF	steel	1.99	50.5	1.31	33.3	1-3/16"
	V4F4-B	1/2" - 14 NPTF	brass	1.99	50.5	1.31	33.3	1-3/16"
	V4F4-SS	1/2" - 14 NPTF	316 stainless	1.99	50.5	1.31	33.3	1-3/16"
	V4BF4	1/2" - 14 BSPP	steel	1.99	50.5	1.31	33.3	1-3/16"
	V4BF4-B	1/2" - 14 BSPP	brass	1.99	50.5	1.31	33.3	1-3/16"
	V4BF4-SS	1/2" - 14 BSPP	316 stainless	1.99	50.5	1.31	33.3	1-3/16"
	V4OF4	3/4" - 16 ORB	steel	1.99	50.5	1.31	33.3	1-3/16"
	V4F6	3/4" - 14 NPTF	steel	1.99	50.5	1.31	33.3	1-3/16"
3/4"	V6F6	3/4" - 14 NPTF	steel	2.31	58.7	1.65	41.9	1-1/2"
	V6F6-B	3/4" - 14 NPTF	brass	2.31	58.7	1.65	41.9	1-1/2"
	V6F6-SS	3/4" - 14 NPTF	316 stainless	2.31	58.7	1.65	41.9	1-1/2"
	V6BF6	3/4" - 14 BSPP	steel	2.80	71.1	1.65	41.9	1-1/2"
	V6BF6-B	3/4" - 14 BSPP	brass	2.80	71.1	1.65	41.9	1-1/2"
	V6BF6-SS	3/4" - 14 BSPP	316 stainless	2.80	71.1	1.65	41.9	1-1/2"
	V6OF6	1-1/16" - 12 ORB	steel	2.80	71.1	1.65	41.9	1-1/2"
	V8F8	1" - 11-1/2 NPTF	steel	2.60	66.0	2.06	52.3	1-7/8"
1"	V8F8-B	1" - 11-1/2 NPTF	brass	2.60	66.0	2.06	52.3	1-7/8"
	V8F8-SS	1" - 11-1/2 NPTF	316 stainless	2.60	66.0	2.06	52.3	1-7/8"
	V8BF8	1" - 11 BSPP	steel	2.87	72.9	2.06	52.3	1-7/8"
	V8BF8-B	1" - 11 BSPP	brass	2.87	72.9	2.06	52.3	1-7/8"
	V8BF8-SS	1" - 11 BSPP	316 stainless	2.87	72.9	2.06	52.3	1-7/8"
	V8OF8	1-5/16" - 12 ORB	steel	2.85	72.6	2.06	52.3	1-7/8"

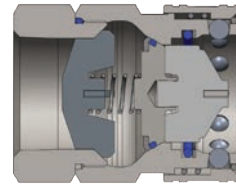
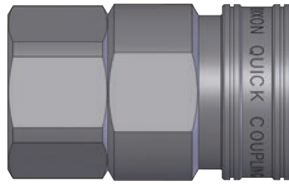

Body Size	V-Series MIL-C-51234 Valved Coupler (Female Threads)							
	Part Detail			Length		Maximum O.D.		Hex inch
	Part #	Threads	Material	inch	mm	inch	mm	
1-1/4"	10VF10	1-1/4" - 11-1/2 NPTF	steel	3.54	89.9	2.19	55.6	2"
	10VF10-B	1-1/4" - 11-1/2 NPTF	brass	3.54	89.9	2.19	55.6	2"
	10VF10-SS	1-1/4" - 11-1/2 NPTF	316 stainless	3.54	89.9	2.19	55.6	2"
	10VBF10	1-1/4" - 11 BSPP	steel	3.54	89.9	2.19	55.6	2"
	10VBF10-B	1-1/4" - 11 BSPP	brass	3.54	89.9	2.19	55.6	2"
	10VBF10-SS	1-1/4" - 11 BSPP	316 stainless	3.54	89.9	2.19	55.6	2"
	10VOF10	1-5/8" - 12 ORB	steel	3.54	89.9	2.19	55.6	2"
1-1/2"	12VF12	1-1/2" - 11-1/2 NPTF	steel	3.27	83.1	2.74	69.6	2-1/2"
	12VF12-B	1-1/2" - 11-1/2 NPTF	brass	3.27	83.1	2.74	69.6	2-1/2"
	12VF12-SS	1-1/2" - 11-1/2 NPTF	316 stainless	3.27	83.1	2.74	69.6	2-1/2"
	12VBF12	1-1/2" - 11 BSPP	steel	3.27	83.1	2.74	69.6	2-1/2"
	12VBF12-B	1-1/2" - 11 BSPP	brass	3.27	83.1	2.74	69.6	2-1/2"
	12VBF12-SS	1-1/2" - 11 BSPP	316 stainless	3.27	83.1	2.74	69.6	2-1/2"
	12VOF12	1-7/8" - 12 ORB	steel	3.27	83.1	2.74	69.6	2-1/2"
2"	16VF16	2" - 11-1/2 NPTF	steel	3.92	99.6	3.83	97.3	3-1/2"
	16VF16-B	2" - 11-1/2 NPTF	brass	3.92	99.6	3.83	97.3	3-1/2"
	16VF16-SS	2" - 11-1/2 NPTF	316 stainless	3.92	99.6	3.83	97.3	3-1/2"
	16VBF16	2" - 11 BSPP	steel	3.92	99.6	3.83	97.3	3-1/2"
	16VBF16-B	2" - 11 BSPP	brass	3.92	99.6	3.83	97.3	3-1/2"
	16VBF16-SS	2" - 11 BSPP	316 stainless	3.92	99.6	3.83	97.3	3-1/2"

Hydraulic Couplings: V-Series

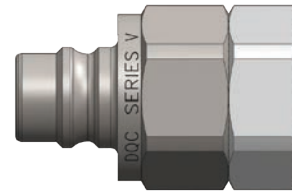
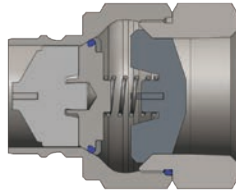

Body Size	V-Series MIL-C-51234 Valved Plug (Female Threads)							
	Part Detail			Length		Maximum O.D.		Hex inch
	Part #	Threads	Material	inch	mm	inch	mm	
1-1/4"	V10F10	1-1/4" - 11-1/2 NPTF	steel	3.41	86.6	2.19	55.6	2"
	V10F10-B	1-1/4" - 11-1/2 NPTF	brass	3.41	86.6	2.19	55.6	2"
	V10F10-SS	1-1/4" - 11-1/2 NPTF	316 stainless	3.41	86.6	2.19	55.6	2"
	V10BF10	1-1/4" - 11 BSPP	steel	3.41	86.6	2.19	55.6	2"
	V10BF10-B	1-1/4" - 11 BSPP	brass	3.41	86.6	2.19	55.6	2"
	V10BF10-SS	1-1/4" - 11 BSPP	316 stainless	3.41	86.6	2.19	55.6	2"
	V100F10	1-5/8" - 12 ORB	steel	3.41	86.6	2.19	55.6	2"
1-1/2"	V12F12	1-1/2" - 11-1/2 NPTF	steel	3.35	79.0	2.74	69.6	2-1/2"
	V12F12-B	1-1/2" - 11-1/2 NPTF	brass	3.35	79.0	2.74	69.6	2-1/2"
	V12F12-SS	1-1/2" - 11-1/2 NPTF	316 stainless	3.35	79.0	2.74	69.6	2-1/2"
	V12BF12	1-1/2" - 11 BSPP	steel	3.35	79.0	2.74	69.6	2-1/2"
	V12BF12-B	1-1/2" - 11 BSPP	brass	3.35	79.0	2.74	69.6	2-1/2"
	V12BF12-SS	1-1/2" - 11 BSPP	316 stainless	3.35	79.0	2.74	69.6	2-1/2"
	V120F12	1-7/8" - 12 ORB	steel	3.35	79.0	2.74	69.6	2-1/2"
2"	V16F16	2" - 11-1/2 NPTF	steel	3.72	94.5	3.83	97.3	3-1/2"
	V16F16-B	2" - 11-1/2 NPTF	brass	3.72	94.5	3.83	97.3	3-1/2"
	V16F16-SS	2" - 11-1/2 NPTF	316 stainless	3.72	94.5	3.83	97.3	3-1/2"
	V16BF16	2" - 11 BSPP	steel	3.72	94.5	3.83	97.3	3-1/2"
	V16BF16-B	2" - 11 BSPP	brass	3.72	94.5	3.83	97.3	3-1/2"
	V16BF16-SS	2" - 11 BSPP	316 stainless	3.72	94.5	3.83	97.3	3-1/2"

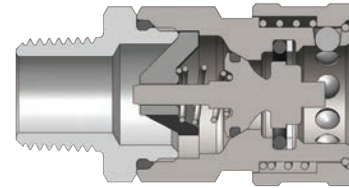
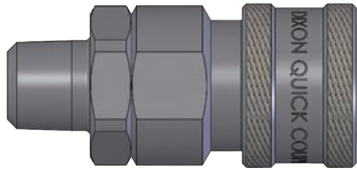

Body Size	V-Series MIL-C-51234 Valved Coupler (Male Threads)							
	Part Detail			Length		Maximum O.D.		Hex inch
	Part #	Threads	Material	inch	mm	inch	mm	
1/4"	2VM1	1/8" - 27 NPTF	steel	2.12	53.8	0.99	25.1	7/8"
	2VM2	1/4" - 18 NPTF	steel	2.12	53.8	0.99	25.1	7/8"
	2VM2-B	1/4" - 18 NPTF	brass	2.12	53.8	0.99	25.1	7/8"
	2VM2-SS	1/4" - 18 NPTF	316 stainless	2.12	53.8	0.99	25.1	7/8"
3/8"	3VM3	3/8" - 18 NPTF	steel	2.32	58.9	1.18	30.0	1"
	3VM3-B	3/8" - 18 NPTF	brass	2.32	58.9	1.18	30.0	1"
	3VM3-SS	3/8" - 18 NPTF	316 stainless	2.32	58.9	1.18	30.0	1"
1/2"	4VM4	1/2" - 14 NPTF	steel	2.54	64.5	1.36	34.5	1-3/16"
	4VM4-B	1/2" - 14 NPTF	brass	2.54	64.5	1.36	34.5	1-3/16"
	4VM4-SS	1/2" - 14 NPTF	316 stainless	2.54	64.5	1.36	34.5	1-3/16"
3/4"	6VM6	3/4" - 14 NPTF	steel	3.07	78.0	1.67	42.4	1-1/2"
	6VM6-B	3/4" - 14 NPTF	brass	3.07	78.0	1.67	42.4	1-1/2"
	6VM6-SS	3/4" - 14 NPTF	316 stainless	3.07	78.0	1.67	42.4	1-1/2"
1"	8VM8	1" - 11-1/2 NPTF	steel	3.32	84.3	2.06	52.3	1-7/8"
	8VM8-B	1" - 11-1/2 NPTF	brass	3.32	84.3	2.06	52.3	1-7/8"
	8VM8-SS	1" - 11-1/2 NPTF	316 stainless	3.32	84.3	2.06	52.3	1-7/8"
1-1/4"	10VM10	1-1/4" - 11-1/2 NPTF	steel	3.59	91.2	2.19	55.6	2"
	10VM10-B	1-1/4" - 11-1/2 NPTF	brass	3.59	91.2	2.19	55.6	2"
	10VM10-SS	1-1/4" - 11-1/2 NPTF	316 stainless	3.59	91.2	2.19	55.6	2"
1-1/2"	12VM12	1-1/2" - 11-1/2 NPTF	steel	4.01	101.9	2.74	69.6	2-1/2"
	12VM12-B	1-1/2" - 11-1/2 NPTF	brass	4.01	101.9	2.74	69.6	2-1/2"
	12VM12-SS	1-1/2" - 11-1/2 NPTF	316 stainless	4.01	101.9	2.74	69.6	2-1/2"
2"	16VM16	2" - 11-1/2 NPTF	steel	4.54	115.3	3.83	97.3	3-1/2"
	16VM16-B	2" - 11-1/2 NPTF	brass	4.54	115.3	3.83	97.3	3-1/2"
	16VM16-SS	2" - 11-1/2 NPTF	316 stainless	4.54	115.3	3.83	97.3	3-1/2"

Hydraulic Couplings: V-Series

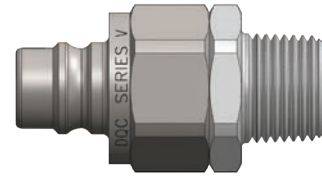
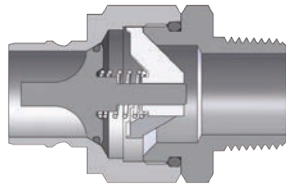

Body Size	V-Series MIL-C-51234 Valved Plug (Male Threads)							
	Part Detail			Length		Maximum O.D.		Hex inch
	Part #	Threads	Material	inch	mm	inch	mm	
1/4"	V2M1	1/8" - 27 NPTF	steel	2.06	52.3	0.97	24.6	7/8"
	V2M2	1/4" - 18 NPTF	steel	2.06	52.3	0.97	24.6	7/8"
	V2M2-B	1/4" - 18 NPTF	brass	2.06	52.3	0.97	24.6	7/8"
	V2M2-SS	1/4" - 18 NPTF	316 stainless	2.06	52.3	0.97	24.6	7/8"
3/8"	V3M3	3/8" - 18 NPTF	steel	2.25	57.2	1.10	27.9	1"
	V3M3-B	3/8" - 18 NPTF	brass	2.25	57.2	1.10	27.9	1"
	V3M3-SS	3/8" - 18 NPTF	316 stainless	2.25	57.2	1.10	27.9	1"
1/2"	V4M4	1/2" - 14 NPTF	steel	2.40	61.0	1.31	33.3	1-3/16"
	V4M4-B	1/2" - 14 NPTF	brass	2.40	61.0	1.31	33.3	1-3/16"
	V4M4-SS	1/2" - 14 NPTF	316 stainless	2.40	61.0	1.31	33.3	1-3/16"
3/4"	V6M6	3/4" - 14 NPTF	steel	2.91	73.9	1.65	41.9	1-1/2"
	V6M6-B	3/4" - 14 NPTF	brass	2.91	73.9	1.65	41.9	1-1/2"
	V6M6-SS	3/4" - 14 NPTF	316 stainless	2.91	73.9	1.65	41.9	1-1/2"
1"	V8M8	1" - 11-1/2 NPTF	steel	3.22	81.8	2.06	52.3	1-7/8"
	V8M8-B	1" - 11-1/2 NPTF	brass	3.22	81.8	2.06	52.3	1-7/8"
	V8M8-SS	1" - 11-1/2 NPTF	316 stainless	3.22	81.8	2.06	52.3	1-7/8"
1-1/4"	V10M10	1-1/4" - 11-1/2 NPTF	steel	3.46	87.9	2.19	55.6	2"
	V10M10-B	1-1/4" - 11-1/2 NPTF	brass	3.46	87.9	2.19	55.6	2"
	V10M10-SS	1-1/4" - 11-1/2 NPTF	316 stainless	3.46	87.9	2.19	55.6	2"
1-1/2"	V12M12	1-1/2" - 11-1/2 NPTF	steel	3.85	97.8	2.74	69.6	2-1/2"
	V12M12-B	1-1/2" - 11-1/2 NPTF	brass	3.85	97.8	2.74	69.6	2-1/2"
	V12M12-SS	1-1/2" - 11-1/2 NPTF	316 stainless	3.85	97.8	2.74	69.6	2-1/2"
2"	V16M16	2" - 11-1/2 NPTF	steel	4.34	110.2	3.83	97.3	3-1/2"
	V16M16-B	2" - 11-1/2 NPTF	brass	4.34	110.2	3.83	97.3	3-1/2"
	V16M16-SS	2" - 11-1/2 NPTF	316 stainless	4.34	110.2	3.83	97.3	3-1/2"

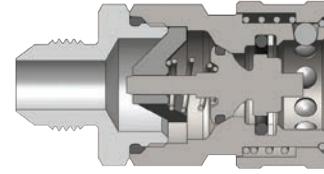
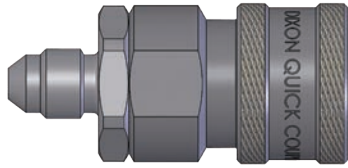

Body Size	V-Series MIL-C-51234 Valved Coupler (JIC Male Threads)							
	Part Detail			Length		Maximum O.D.		Hex inch
	Part #	Threads	Material	inch	mm	inch	mm	
1/4"	2VJM2	7/16" - 20 JIC	steel	2.12	53.8	0.99	25.1	7/8"
3/8"	3VJM3	9/16" - 18 JIC	steel	2.32	58.9	1.18	30.0	1"
1/2"	4VJM4	3/4" - 16 JIC	steel	2.54	64.5	1.36	34.5	1-3/16"
3/4"	6VJM6	1-1/16" - 12 JIC	steel	3.07	78.0	1.67	42.4	1-1/2"
1"	8VJM8	1-5/16" - 12 JIC	steel	3.32	84.3	2.06	52.3	1-7/8"
1-1/4"	10VJM10	1-5/8" - 12 JIC	steel	3.59	91.2	2.19	55.6	2"

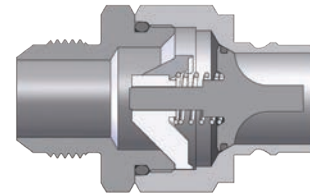
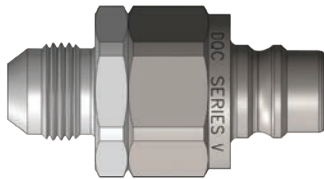

Body Size	V-Series MIL-C-51234 Valved Plug (JIC Male Threads)							
	Part Detail			Length		Maximum O.D.		Hex inch
	Part #	Threads	Material	inch	mm	inch	mm	
1/4"	V2JM2	7/16" - 20 JIC	steel	2.06	52.3	0.97	24.6	7/8"
3/8"	V3JM3	9/16" - 18 JIC	steel	2.25	57.2	1.1	27.9	1"
1/2"	V4JM4	3/4" - 16 JIC	steel	2.40	61.0	1.31	33.3	1-3/16"
3/4"	V6JM6	1-1/16" - 12 JIC	steel	2.91	73.9	1.65	41.9	1-1/2"
1"	V8JM8	1-5/16" - 12 JIC	steel	3.22	81.8	2.06	52.3	1-7/8"
1-1/4"	V10JM10	1-5/8" - 12 JIC	steel	3.46	87.9	2.19	55.6	2"

Hydraulic Couplings: V-Series

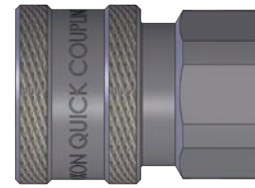
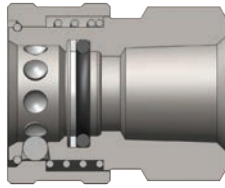

Body Size	V-Series MIL-C-51234 Unvalved Coupler (Female Threads)							
	Part Detail			Length		Maximum O.D.		Hex inch
	Part #	Threads	Material	inch	mm	inch	mm	
1/4"	2VF2-E	1/4" - 18 NPTF	steel	1.36	34.5	0.99	25.1	7/8"
	2VF2-B-E	1/4" - 18 NPTF	brass	1.36	34.5	0.99	25.1	7/8"
	2VF2-SS-E	1/4" - 18 NPTF	316 stainless	1.36	34.5	0.99	25.1	7/8"
	2VBF2-E	1/4" - 19 BSPP	steel	1.36	34.5	0.99	25.1	7/8"
	2VBF2-B-E	1/4" - 19 BSPP	brass	1.36	34.5	0.99	25.1	7/8"
	2VBF2-SS-E	1/4" - 19 BSPP	316 stainless	1.36	34.5	0.99	25.1	7/8"
3/8"	3VF3-E	3/8" - 18 NPTF	steel	1.50	38.1	1.18	30.0	7/8"
	3VF3-B-E	3/8" - 18 NPTF	brass	1.50	38.1	1.18	30.0	7/8"
	3VF3-SS-E	3/8" - 18 NPTF	316 stainless	1.50	38.1	1.18	30.0	7/8"
	3VBF3-E	3/8" - 19 BSPP	steel	1.50	38.1	1.18	30.0	7/8"
	3VBF3-B-E	3/8" - 19 BSPP	brass	1.50	38.1	1.18	30.0	7/8"
	3VBF3-SS-E	3/8" - 19 BSPP	316 stainless	1.50	38.1	1.18	30.0	7/8"
1/2"	4VF4-E	1/2" - 14 NPTF	steel	1.64	41.7	1.37	34.8	1-3/16"
	4VF4-B-E	1/2" - 14 NPTF	brass	1.64	41.7	1.37	34.8	1-3/16"
	4VF4-SS-E	1/2" - 14 NPTF	316 stainless	1.64	41.7	1.37	34.8	1-3/16"
	4VBF4-E	1/2" - 14 BSPP	steel	1.64	41.7	1.37	34.8	1-3/16"
	4VBF4-B-E	1/2" - 14 BSPP	brass	1.64	41.7	1.37	34.8	1-3/16"
	4VBF4-SS-E	1/2" - 14 BSPP	316 stainless	1.64	41.7	1.37	34.8	1-3/16"
3/4"	6VF6-E	3/4" - 14 NPTF	steel	1.96	49.8	1.67	42.4	1-1/2"
	6VF6-B-E	3/4" - 14 NPTF	brass	1.96	49.8	1.67	42.4	1-1/2"
	6VF6-SS-E	3/4" - 14 NPTF	316 stainless	1.96	49.8	1.67	42.4	1-1/2"
	6VBF6-E	3/4" - 14 BSPP	steel	1.96	49.8	1.67	42.4	1-1/2"
	6VBF6-B-E	3/4" - 14 BSPP	brass	1.96	49.8	1.67	42.4	1-1/2"
	6VBF6-SS-E	3/4" - 14 BSPP	316 stainless	1.96	49.8	1.67	42.4	1-1/2"
1"	8VF8-E	1" - 11-1/2 NPTF	steel	2.10	53.3	1.99	50.5	1-13/16"
	8VF8-B-E	1" - 11-1/2 NPTF	brass	2.10	53.3	1.99	50.5	1-13/16"
	8VF8-SS-E	1" - 11-1/2 NPTF	316 stainless	2.10	53.3	1.99	50.5	1-13/16"
	8VBF8-E	1" - 11 BSPP	steel	2.10	53.3	1.99	50.5	1-13/16"
	8VBF8-B-E	1" - 11 BSPP	brass	2.10	53.3	1.99	50.5	1-13/16"
	8VBF8-SS-E	1" - 11 BSPP	316 stainless	2.10	53.3	1.99	50.5	1-13/16"
1-1/4"	10VF10-E	1-1/4" - 11-1/2 NPTF	steel	2.28	57.9	2.19	55.6	2"
	10VF10-B-E	1-1/4" - 11-1/2 NPTF	brass	2.28	57.9	2.19	55.6	2"
	10VF10-SS-E	1-1/4" - 11-1/2 NPTF	316 stainless	2.28	57.9	2.19	55.6	2"
	10VBF10-E	1-1/4" - 11 BSPP	steel	2.28	57.9	2.19	55.6	2"
	10VBF10-B-E	1-1/4" - 11 BSPP	brass	2.28	57.9	2.19	55.6	2"
	10VBF10-SS-E	1-1/4" - 11 BSPP	316 stainless	2.28	57.9	2.19	55.6	2"
1-1/2"	12VF12-E	1-1/2" - 11-1/2 NPTF	steel	2.57	65.3	2.74	69.6	2-1/2"
	12VF12-B-E	1-1/2" - 11-1/2 NPTF	brass	2.57	65.3	2.74	69.6	2-1/2"
	12VF12-SS-E	1-1/2" - 11-1/2 NPTF	316 stainless	2.57	65.3	2.74	69.6	2-1/2"
2"	16VF16-E	2" - 11-1/2 NPTF	steel	2.48	63.0	3.56	90.4	3-1/4"
	16VF16-B-E	2" - 11-1/2 NPTF	brass	2.48	63.0	3.56	90.4	3-1/4"
	16VF16-SS-E	2" - 11-1/2 NPTF	316 stainless	2.48	63.0	3.56	90.4	3-1/4"

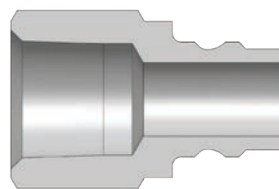

Body Size	V-Series MIL-C-51234 Unvalved Plug (Female Threads)							
	Part Detail			Length		Maximum O.D.		Hex inch
	Part #	Threads	Material	inch	mm	inch	mm	
1/4"	V2F2-E	1/4" - 18 NPTF	steel	1.27	32.3	0.69	17.5	5/8"
	V2F2-B-E	1/4" - 18 NPTF	brass	1.27	32.3	0.69	17.5	5/8"
	V2F2-SS-E	1/4" - 18 NPTF	316 stainless	1.27	32.3	0.69	17.5	5/8"
	V2BF2-E	1/4" - 19 BSPP	steel	1.27	32.3	0.69	17.5	5/8"
	V2BF2-B-E	1/4" - 19 BSPP	brass	1.27	32.3	0.69	17.5	5/8"
	V2BF2-SS-E	1/4" - 19 BSPP	316 stainless	1.27	32.3	0.69	17.5	5/8"
3/8"	V3F3-E	3/8" - 18 NPTF	steel	1.41	35.8	0.90	22.9	13/16"
	V3F3-B-E	3/8" - 18 NPTF	brass	1.41	35.8	0.90	22.9	13/16"
	V3F3-SS-E	3/8" - 18 NPTF	316 stainless	1.41	35.8	0.90	22.9	13/16"
	V3BF3-E	3/8" - 19 BSPP	steel	1.41	35.8	0.90	22.9	13/16"
	V3BF3-B-E	3/8" - 19 BSPP	brass	1.41	35.8	0.90	22.9	13/16"
	V3BF3-SS-E	3/8" - 19 BSPP	316 stainless	1.41	35.8	0.90	22.9	13/16"
1/2"	V4F4-E	1/2" - 14 NPTF	steel	1.72	43.7	1.10	27.9	1"
	V4F4-B-E	1/2" - 14 NPTF	brass	1.72	43.7	1.10	27.9	1"
	V4F4-SS-E	1/2" - 14 NPTF	316 stainless	1.72	43.7	1.10	27.9	1"
	V4BF4-E	1/2" - 14 BSPP	steel	1.72	43.7	1.10	27.9	1"
	V4BF4-B-E	1/2" - 14 BSPP	brass	1.72	43.7	1.10	27.9	1"
	V4BF4-SS-E	1/2" - 14 BSPP	316 stainless	1.72	43.7	1.10	27.9	1"
3/4"	V6F6-E	3/4" - 14 NPTF	steel	1.86	47.2	1.31	33.3	1-3/16"
	V6F6-B-E	3/4" - 14 NPTF	brass	1.86	47.2	1.31	33.3	1-3/16"
	V6F6-SS-E	3/4" - 14 NPTF	316 stainless	1.86	47.2	1.31	33.3	1-3/16"
	V6BF6-E	3/4" - 14 BSPP	steel	1.86	47.2	1.31	33.3	1-3/16"
	V6BF6-B-E	3/4" - 14 BSPP	brass	1.86	47.2	1.31	33.3	1-3/16"
	V6BF6-SS-E	3/4" - 14 BSPP	316 stainless	1.86	47.2	1.31	33.3	1-3/16"
1"	V8F8-E	1" - 11-1/2 NPTF	steel	2.08	52.8	1.65	41.9	1-1/2"
	V8F8-B-E	1" - 11-1/2 NPTF	brass	2.08	52.8	1.65	41.9	1-1/2"
	V8F8-SS-E	1" - 11-1/2 NPTF	316 stainless	2.08	52.8	1.65	41.9	1-1/2"
	V8BF8-E	1" - 11 BSPP	steel	2.08	52.8	1.65	41.9	1-1/2"
	V8BF8-B-E	1" - 11 BSPP	brass	2.08	52.8	1.65	41.9	1-1/2"
	V8BF8-SS-E	1" - 11 BSPP	316 stainless	2.08	52.8	1.65	41.9	1-1/2"
1-1/4"	V10F10-E	1-1/4" - 11-1/2 NPTF	steel	2.22	56.4	2.06	52.3	1-7/8"
	V10F10-B-E	1-1/4" - 11-1/2 NPTF	brass	2.22	56.4	2.06	52.3	1-7/8"
	V10F10-SS-E	1-1/4" - 11-1/2 NPTF	316 stainless	2.22	56.4	2.06	52.3	1-7/8"
	V10BF10-E	1-1/4" - 11 BSPP	steel	2.22	56.4	2.06	52.3	1-7/8"
	V10BF10-B-E	1-1/4" - 11 BSPP	brass	2.22	56.4	2.06	52.3	1-7/8"
	V10BF10-SS-E	1-1/4" - 11 BSPP	316 stainless	2.22	56.4	2.06	52.3	1-7/8"
1-1/2"	V12F12-E	1-1/2" - 11-1/2 NPTF	steel	2.44	62.0	2.33	59.2	2-1/8"
	V12F12-B-E	1-1/2" - 11-1/2 NPTF	brass	2.44	62.0	2.33	59.2	2-1/8"
	V12F12-SS-E	1-1/2" - 11-1/2 NPTF	316 stainless	2.44	62.0	2.33	59.2	2-1/8"
2"	V16F16-E	2" - 11-1/2 NPTF	steel	2.60	66.0	3.01	76.5	2-3/4"
	V16F16-B-E	2" - 11-1/2 NPTF	brass	2.60	66.0	3.01	76.5	2-3/4"
	V16F16-SS-E	2" - 11-1/2 NPTF	316 stainless	2.60	66.0	3.01	76.5	2-3/4"

Hydraulic Couplings: V-Series

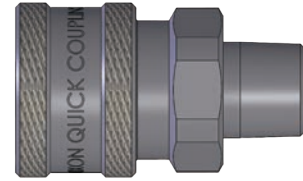
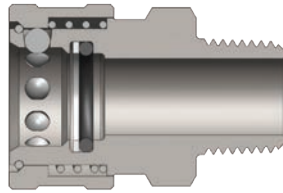

Body Size	V-Series MIL-C-51234 Unvalved Coupler (Male Threads)							
	Part Detail			Length		Maximum O.D.		Hex inch
	Part #	Threads	Material	inch	mm	inch	mm	
1/4"	2VM2-E	1/4" - 18 NPTF	steel	1.82	46.2	0.99	25.1	5/8"
	2VM2-B-E	1/4" - 18 NPTF	brass	1.82	46.2	0.99	25.1	5/8"
	2VM2-SS-E	1/4" - 18 NPTF	316 stainless	1.82	46.2	0.99	25.1	5/8"
3/8"	3VM3-E	3/8" - 18 NPTF	steel	1.76	44.7	1.18	30.0	13/16"
	3VM3-B-E	3/8" - 18 NPTF	brass	1.76	44.7	1.18	30.0	13/16"
	3VM3-SS-E	3/8" - 18 NPTF	316 stainless	1.76	44.7	1.18	30.0	13/16"
1/2"	4VM4-E	1/2" - 14 NPTF	steel	2.03	51.6	1.37	34.8	1"
	4VM4-B-E	1/2" - 14 NPTF	brass	2.03	51.6	1.37	34.8	1"
	4VM4-SS-E	1/2" - 14 NPTF	316 stainless	2.03	51.6	1.37	34.8	1"
3/4"	6VM6-E	3/4" - 14 NPTF	steel	2.29	58.2	1.67	42.4	1-3/16"
	6VM6-B-E	3/4" - 14 NPTF	brass	2.29	58.2	1.67	42.4	1-3/16"
	6VM6-SS-E	3/4" - 14 NPTF	316 stainless	2.29	58.2	1.67	42.4	1-3/16"
1"	8VM8-E	1" - 11-1/2 NPTF	steel	2.39	60.7	1.99	50.5	1-1/2"
	8VM8-B-E	1" - 11-1/2 NPTF	brass	2.39	60.7	1.99	50.5	1-1/2"
	8VM8-SS-E	1" - 11-1/2 NPTF	316 stainless	2.39	60.7	1.99	50.5	1-1/2"
1-1/4"	10VM10-E	1-1/4" - 11-1/2 NPTF	steel	2.78	70.6	2.19	55.6	1-7/8"
	10VM10-SS-E	1-1/4" - 11-1/2 NPTF	316 stainless	2.78	70.6	2.19	55.6	1-7/8"
1-1/2"	12VM12-E	1-1/2" - 11-1/2 NPTF	steel	3.08	78.2	2.74	69.6	2-1/8"
	12VM12-SS-E	1-1/2" - 11-1/2 NPTF	316 stainless	3.08	78.2	2.74	69.6	2-1/8"
2"	16VM16-E	2" - 11-1/2 NPTF	steel	3.10	78.7	3.56	90.4	2-1/2"
	16VM16-SS-E	2" - 11-1/2 NPTF	316 stainless	3.10	78.7	3.56	90.4	2-1/2"

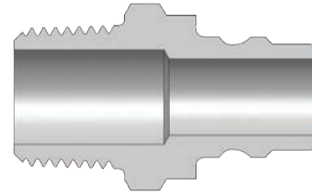
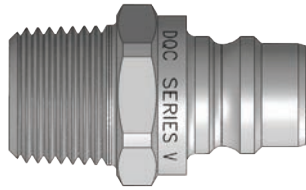

Body Size	V-Series MIL-C-51234 Unvalved Plug (Male Threads)							
	Part Detail			Length		Maximum O.D.		Hex inch
	Part #	Threads	Material	inch	mm	inch	mm	
1/4"	V2M2-E	1/4" - 18 NPTF	steel	1.52	38.6	0.69	17.5	5/8"
	V2M2-B-E	1/4" - 18 NPTF	brass	1.52	38.6	0.69	17.5	5/8"
	V2M2-SS-E	1/4" - 18 NPTF	316 stainless	1.52	38.6	0.69	17.5	5/8"
3/8"	V3M3-E	3/8" - 18 NPTF	steel	1.72	43.7	0.90	22.9	13-16"
	V3M3-B-E	3/8" - 18 NPTF	brass	1.72	43.7	0.90	22.9	13/16"
	V3M3-SS-E	3/8" - 18 NPTF	316 stainless	1.72	43.7	0.90	22.9	13/16"
1/2"	V4M4-E	1/2" - 14 NPTF	steel	1.80	45.7	1.10	27.9	1"
	V4M4-B-E	1/2" - 14 NPTF	brass	1.80	45.7	1.10	27.9	1"
	V4M4-SS-E	1/2" - 14 NPTF	316 stainless	1.80	45.7	1.10	27.9	1"
3/4"	V6M6-E	3/4" - 14 NPTF	steel	2.19	55.6	1.31	33.3	1-3/16"
	V6M6-B-E	3/4" - 14 NPTF	brass	2.19	55.6	1.31	33.3	1-3/16"
	V6M6-SS-E	3/4" - 14 NPTF	316 stainless	2.19	55.6	1.31	33.3	1-3/16"
1"	V8M8-E	1" - 11-1/2 NPTF	steel	2.31	58.7	1.65	41.9	1-1/2"
	V8M8-B-E	1" - 11-1/2 NPTF	brass	2.31	58.7	1.65	41.9	1-1/2"
	V8M8-SS-E	1" - 11-1/2 NPTF	316 stainless	2.31	58.7	1.65	41.9	1-1/2"
1-1/4"	V10M10-E	1-1/4" - 11-1/2 NPTF	steel	2.14	54.4	2.06	52.3	1-7/8"
	V10M10-SS-E	1-1/4" - 11-1/2 NPTF	316 stainless	2.14	54.4	2.06	52.3	1-7/8"
1-1/2"	V12M12-E	1-1/2" - 11-1/2 NPTF	steel	2.34	59.4	2.33	59.2	2-1/8"
	V12M12-SS-E	1-1/2" - 11-1/2 NPTF	316 stainless	2.34	59.4	2.33	59.2	2-1/8"
2"	V16M16-E	2" - 11-1/2 NPTF	steel	3.06	77.7	2.74	69.6	2-1/2"
	V16M16-SS-E	2" - 11-1/2 NPTF	316 stainless	3.06	77.7	2.74	69.6	2-1/2"



Body Size	V-Series Dust Caps and Dust Plugs		
	Part Detail		
	Coupler Dust Plug	Plug Dust Cap	Material
1/4"	1HDP	V2DC	Nitrile
3/8"	3VDP-V3DC combination dust cap/plug		Nitrile
1/2"	3KDP-K3DC combination dust cap/plug		Nitrile
3/4"	6VDP-V6DC combination dust cap/plug		Nitrile
1"	8VDP-V8DC combination dust cap/plug		Nitrile



Body Size	V-Series Coupler Rigid Dust Plug		
	Part Detail		
	Part #	Lanyard	Body
1/4"	2VDP-A	steel cable	aluminum
3/8"	3VDP-A	steel cable	aluminum
1/2"	4VDP-A	steel cable	aluminum
3/4"	6VDP-A	steel cable	aluminum
1"	8VDP-A	steel cable	aluminum
1-1/4"	10VDP-A	steel cable	aluminum
1-1/2"	12VDP-A	steel cable	aluminum
2"	16VDP-A	steel cable	aluminum



Body Size	V-Series Plug Rigid Dust Cap		
	Part Detail		
	Part #	Lanyard	Body
1/4"	V2DC-A	steel cable	aluminum
3/8"	V3DC-A	steel cable	aluminum
1/2"	V4DC-A	steel cable	aluminum
3/4"	V6DC-A	steel cable	aluminum
1"	V8DC-A	steel cable	aluminum
1-1/4"	V10DC-A	steel cable	aluminum
1-1/2"	V12DC-A	steel cable	aluminum
2"	V16DC-A	steel cable	aluminum

Body Size	V-Series MIL-C-51234 Coupler Seal Kits			
	Part Detail			Seal Kit Contents
	Part #	Coupler Style	Seal Material	
1/4"	2V-SKIT	all	Nitrile	Body/adapter O-rings and PTFE back-up
	F-2V-SKIT	all	FKM	Body/adapter O-rings and PTFE back-up
	P-2V-SKIT	all	EPDM	Body/adapter O-rings and PTFE back-up
3/8"	3V-SKIT	all	Nitrile	Body/adapter O-rings and PTFE back-up
	F-3V-SKIT	all	FKM	Body/adapter O-rings and PTFE back-up
	P-3V-SKIT	all	EPDM	Body/adapter O-rings and PTFE back-up
1/2"	4V-SKIT	all	Nitrile	Body/adapter O-rings and PTFE back-up
	F-4V-SKIT	all	FKM	Body/adapter O-rings and PTFE back-up
	P-4V-SKIT	all	EPDM	Body/adapter O-rings and PTFE back-up
3/4"	6V-SKIT	all	Nitrile	Body/adapter O-rings and PTFE back-up
	F-6V-SKIT	all	FKM	Body/adapter O-rings and PTFE back-up
	P-6V-SKIT	all	EPDM	Body/adapter O-rings and PTFE back-up
1"	8V-SKIT	all	Nitrile	Body/adapter O-rings and PTFE back-up
	F-8V-SKIT	all	FKM	Body/adapter O-rings and PTFE back-up
	P-8V-SKIT	all	EPDM	Body/adapter O-rings and PTFE back-up
1-1/4"	10V-SKIT	all	Nitrile	Body/adapter/valve O-rings and back-up
	F-10V-SKIT	all	FKM	Body/adapter/valve O-rings and back-up
	P-10V-SKIT	all	EPDM	Body/adapter/valve O-rings and back-up
1-1/2"	12V-SKIT	all	Nitrile	Body/adapter/valve O-rings and back-up
	F-12V-SKIT	all	FKM	Body/adapter/valve O-rings and back-up
	P-12V-SKIT	all	EPDM	Body/adapter/valve O-rings and back-up
2"	16V-SKIT	all	Nitrile	Body/adapter/valve O-rings and back-up
	F-16V-SKIT	all	FKM	Body/adapter/valve O-rings and back-up
	P-16V-SKIT	all	EPDM	Body/adapter/valve O-rings and back-up

Hydraulic Couplings: V-Series

Body Size	V-Series MIL-C-51234 Coupler Repair Kits			
	Part Detail			Repair Kit Contents (for one coupler)
	Part #	Coupler Material	Seal Material	
1/4"	2V-RKIT	steel	Nitrile	steel valve assembly and adapter O-ring
	2V-BRKIT	brass	Nitrile	brass valve assembly and adapter O-ring
	2V-SSRKIT	316 stainless	Nitrile	316 SS valve assembly and adapter O-ring
3/8"	3V-RKIT	steel	Nitrile	steel valve assembly and adapter O-ring
	3V-BRKIT	brass	Nitrile	brass valve assembly and adapter O-ring
	3V-SSRKIT	316 stainless	Nitrile	316 SS valve assembly and adapter O-ring
1/2"	4V-RKIT	steel	Nitrile	steel valve assembly and adapter O-ring
	4V-BRKIT	brass	Nitrile	brass valve assembly and adapter O-ring
	4V-SSRKIT	316 stainless	Nitrile	316 SS valve assembly and adapter O-ring
3/4"	6V-RKIT	steel	Nitrile	steel valve assembly and adapter O-ring
	6V-BRKIT	brass	Nitrile	brass valve assembly and adapter O-ring
	6V-SSRKIT	316 stainless	Nitrile	316 SS valve assembly and adapter O-ring
1"	8V-RKIT	steel	Nitrile	steel valve assembly and adapter O-ring
	8V-BRKIT	brass	Nitrile	brass valve assembly and adapter O-ring
	8V-SSRKIT	316 stainless	Nitrile	316 SS valve assembly and adapter O-ring
1-1/4"	140030-10	steel	Nitrile	steel valve assembly and adapter O-ring
	140032-10	316 stainless	Nitrile	316 SS valve assembly and adapter O-ring
1-1/2"	140030-12	steel	Nitrile	steel valve assembly and adapter O-ring
	140032-12	316 stainless	Nitrile	316 SS valve assembly and adapter O-ring
2"	140030-16	steel	Nitrile	steel valve assembly and adapter O-ring
	140032-16	316 stainless	Nitrile	316 SS valve assembly and adapter O-ring

Body Size	V-Series MIL-C-51234 Plug Repair Kits			
	Part Detail			Repair Kit Contents (for one plug)
	Part #	Coupler Material	Seal Material	
1/4"	V2-RKIT	steel	Nitrile	steel valve assembly and adapter O-ring
	V2-BRKIT	brass	Nitrile	brass valve assembly and adapter O-ring
	V2-SSRKIT	316 stainless	Nitrile	316 SS valve assembly and adapter O-ring
3/8"	V3-RKIT	steel	Nitrile	steel valve assembly and adapter O-ring
	V3-BRKIT	brass	Nitrile	brass valve assembly and adapter O-ring
	V3-SSRKIT	316 stainless	Nitrile	316 SS valve assembly and adapter O-ring
1/2"	V4-RKIT	steel	Nitrile	steel valve assembly and adapter O-ring
	V4-BRKIT	brass	Nitrile	brass valve assembly and adapter O-ring
	V4-SSRKIT	316 stainless	Nitrile	316 SS valve assembly and adapter O-ring
3/4"	V6-RKIT	steel	Nitrile	steel valve assembly and adapter O-ring
	V6-BRKIT	brass	Nitrile	brass valve assembly and adapter O-ring
	V6-SSRKIT	316 stainless	Nitrile	316 SS valve assembly and adapter O-ring
1"	V8-RKIT	steel	Nitrile	steel valve assembly and adapter O-ring
	V8-BRKIT	brass	Nitrile	brass valve assembly and adapter O-ring
	V8-SSRKIT	316 stainless	Nitrile	316 SS valve assembly and adapter O-ring
1-1/4"	140030-10	steel	Nitrile	steel valve assembly and adapter O-ring
	140032-10	316 stainless	Nitrile	316 SS valve assembly and adapter O-ring
1-1/2"	140030-12	steel	Nitrile	steel valve assembly and adapter O-ring
	140032-12	316 stainless	Nitrile	316 SS valve assembly and adapter O-ring
2"	140030-16	steel	Nitrile	steel valve assembly and adapter O-ring
	140032-16	316 stainless	Nitrile	316 SS valve assembly and adapter O-ring

Interchange Data

- European interchange
- TEMA 3800, 5000, 7500, 10000 Series
- CEJN Series 525

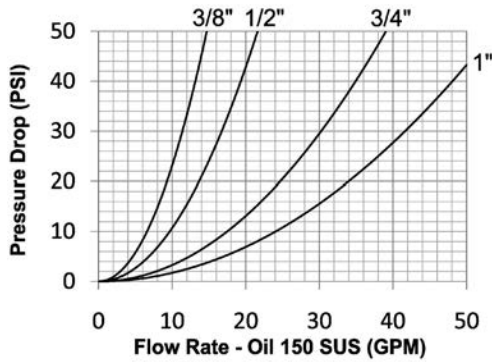

Materials

- Machined components are manufactured using solid steel bar stock
- Stainless steel balls, retaining rings, and springs maximize corrosion resistance and extend service life.
- Steel componentry is plated using ROHS-compliant trivalent chrome
- Steel coupler sleeves are hardened to resist deformation and maximize service life
- Steel plugs are hardened to provide heavy-duty performance

Seal Components

- Nitrile seals are standard, providing a temperature range of **-40°F to 250°F (-40°C to 121°C)**
- Couplers have a redundant O-ring sealing system (dual O-rings with inner PTFE back-up ring)
- Valve seals are crimped in place to maintain integrity during excessive flow conditions and pressurized connection

Rated Pressure Chart

Body Size	TR-Series European Interchange (Connected)			
	Steel Coupler/Plug			
	Maximum Working		Burst	
	PSI	Bar	PSI	Bar
3/8"	5,000	345	20,000	1,400
1/2"	4,000	275	16,500	1,100
3/4"	4,000	275	15,400	1,000
1"	3,200	220	12,800	900

Technical Specifications

Body Size	Interchange Standards				Functional Parameters				
	U.S. Military	U.S. Government	International Standards	ANSI/NFPA Standards	Locking Ball Quantity	Air Inclusion	Fluid Loss	Vacuum inch HG	Flow $\Delta P = 22$ PSI
3/8"	-	-	-	-	9	2.8cc	1.9cc	28	10 GPM
1/2"	-	-	-	-	9	3.9cc	3.1cc	28	15 GPM
3/4"	-	-	-	-	9	10.5cc	10.1cc	28	26 GPM
1"	-	-	-	-	9	14.7cc	14.2cc	28	36 GPM

TR Interchange Profiles

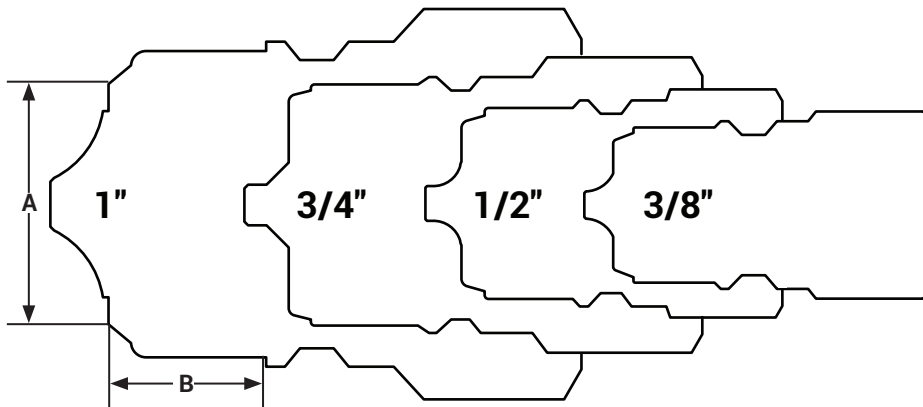

Body Size	A	B
3/8"	0.78	0.53
1/2"	0.97	0.60
3/4"	1.29	0.75
1"	1.61	0.85

Hydraulic Couplings: TR-Series

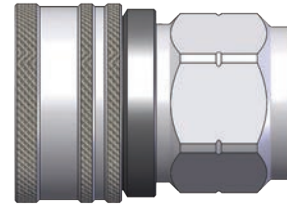
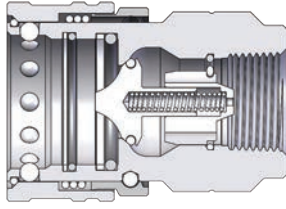

Body Size	TR-Series European Interchange Coupler (Female Threads)							
	Part Detail			Length		Maximum O.D.		Hex mm
	Part #	Threads	Material	inch	mm	inch	mm	
3/8"	3TRF3	3/8" - 18 NPTF	steel	2.52	64.0	1.38	35.0	30
	3TRBF3	3/8" - 19 BSPP	steel	2.52	64.0	1.38	35.0	30
1/2"	4TRF4	1/2" - 14 NPTF	steel	2.62	66.5	1.57	40.0	36
	4TRBF4	1/2" - 14 BSPP	steel	2.62	66.5	1.57	40.0	36
3/4"	6TRF6	3/4" - 14 NPTF	steel	3.35	85.0	2.05	52.0	41
	6TRBF6	3/4" - 14 BSPP	steel	3.35	85.0	2.05	52.0	41
1"	8TRF8	1" - 11-1/2 NPTF	steel	3.90	99.0	2.56	65.0	55
	8TRBF8	1" - 11 BSPP	steel	3.90	99.0	2.56	65.0	55

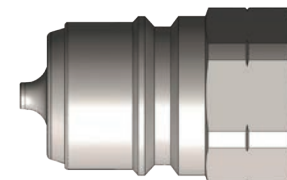
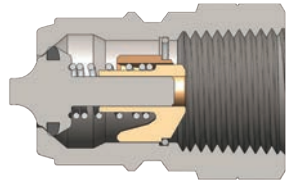

Body Size	TR-Series European Interchange Plug (Female Threads)							
	Part Detail			Length		Maximum O.D.		Hex mm
	Part #	Threads	Material	inch	mm	inch	mm	
3/8"	TR3F3	3/8" - 18 NPTF	steel	1.59	40.5	1.00	25.4	22
	TR3BF3	3/8" - 19 BSPP	steel	1.59	40.5	1.00	25.4	22
1/2"	TR4F4	1/2" - 14 NPTF	steel	1.63	41.5	1.23	31.1	27
	TR4BF4	1/2" - 14 BSPP	steel	1.63	41.5	1.23	31.1	27
3/4"	TR6F6	3/4" - 14 NPTF	steel	2.20	56.0	1.63	41.5	36
	TR6BF6	3/4" - 14 BSPP	steel	2.20	56.0	1.63	41.5	36
1"	TR8F8	1" - 11-1/2 NPTF	steel	2.48	63.0	2.09	53.0	46
	TR8BF8	1" - 11 BSPP	steel	2.48	63.0	2.09	53.0	46

Body Size	TR-Series European Coupler Seal Kits				
	Part Detail			Seal Kit Contents	
	Part #	Coupler Style	Seal Material		
3/8"	3TR-SKIT	all	Nitrile	two O-rings and two PTFE back-up ring	
1/2"	4TR-SKIT	all	Nitrile	two O-rings and two PTFE back-up ring	
3/4"	6TR-SKIT	all	Nitrile	two O-rings and two PTFE back-up ring	
1"	8TR-SKIT	all	Nitrile	two O-rings and one PTFE back-up ring	

Please contact Dixon for dust caps and dust plugs.

Interchange Data

- Interchangeable to ISO16028
- Parker FEM-Series, Holmbury HQ-Series, Hansen FF, Eaton/Aeroquip FD89, Stucchi FIRG/Series A, Faster FFH/FFN/FFI/2FFN/2FFI, Safeway FF49-Series

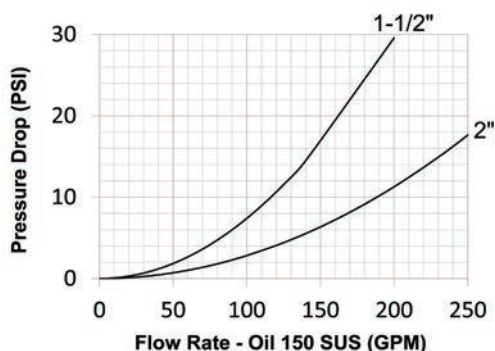
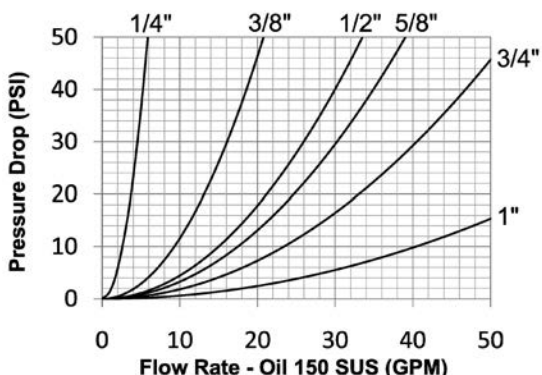

Materials

- Machined components are manufactured using solid steel or 316 stainless steel bar stock
- Stainless steel balls, retaining rings, and springs maximize corrosion resistance and extend service life
- Steel componentry is plated using ROHS compliant zinc nickel for corrosion resistance
- Steel coupler sleeves are hardened to resist deformation and maximize service life
- Steel plugs are hardened to provide resistance to brinelling during impulse service

Seal Components

- 1/4", 3/8", 1/2", 3/4", and 1" plugs have molded polyurethane valve seals, with a temperature range of -65°F to 212°F (-54°C to 100°C)
- 5/8", 1-1/2", and 2" plugs have Nitrile-energized PTFE valve seals, with a temperature range of -40°F to 250°F (-40°C to 121°C)
- Couplers have a polyurethane valve stem O-ring, with a temperature range of -65°F to 212°F (-54°C to 100°C)
- Ancillary coupler and plug seals are Nitrile (Nitrile-N), with a temperature range of -40°F to 250°F (-40°C to 121°C)
- PTFE or TPC-ET anti-extrusion ring protects main coupling valve seal from dynamic impulse pressure damage

HT-Series Correct Connect®

- Blue bands standard, color bands sold separately
- Contact Dixon for additional color band builds
- No special tools required
- Polyurethane color bands

Rated Pressure Chart

Body Size	HT-Series ISO16028 Flushface															
	Steel Coupler/Plug Coupled				316 SS Coupler/Plug Coupled				Steel Coupler Uncoupled				Steel Plug Uncoupled			
	Max. Working		Burst		Max. Working		Burst		Max. Working		Burst		Max. Working		Burst	
	PSI	Bar	PSI	Bar	PSI	Bar	PSI	Bar	PSI	Bar	PSI	Bar	PSI	Bar	PSI	Bar
1/4"	5,000	345	20,000	1,379	-	-	-	-	5,000	345	20,000	1,379	5,000	345	20,000	1,379
3/8"	5,000	345	20,000	1,379	3,500	241	17,500	1,207	5,000	345	20,000	1,379	5,000	345	20,000	1,379
1/2"	5,000	345	20,000	1,379	3,400	234	17,000	1,172	5,000	345	20,000	1,379	5,000	345	20,000	1,379
5/8"	5,000	345	20,000	1,379	2,920	201	14,600	1,007	5,000	345	20,000	1,379	5,000	345	20,000	1,379
3/4"	5,000	345	20,000	1,379	2,920	201	14,600	1,007	5,000	345	20,000	1,379	5,000	345	20,000	1,379
1"	5,000	345	20,000	1,379	2,920	201	14,600	1,007	5,000	345	20,000	1,379	5,000	345	20,000	1,379
1-1/2"	3,000	207	12,000	828	-	-	-	-	3,000	207	12,000	828	3,000	207	12,000	828
2"	3,000	207	12,000	828	-	-	-	-	3,000	207	12,000	828	3,000	207	12,000	828

Technical Specifications

Body Size	Interchange Standards				Functional Parameters					
	U.S. Military	U.S. Government	International Standards	ANSI/NFPA Standards	Locking Ball Quantity	Air Inclusion	Fluid Loss	Vacuum inch HG	Flow ΔP = 15 PSI	
1/4"	-	-	ISO16028	-	12	n/a	0.010cc	N/R	3.2 GPM	
3/8"	-	-	ISO16028	T3.20.15	12	n/a	0.010cc	N/R	11.0 GPM	
1/2"	-	-	ISO16028	-	12	n/a	0.010cc	N/R	18.0 GPM	
5/8"	-	-	ISO16028	-	12	n/a	0.020cc	N/R	21.0 GPM	
3/4"	-	-	ISO16028	-	12	n/a	0.030cc	N/R	28.0 GPM	
1"	-	-	ISO16028	-	12	n/a	0.030cc	N/R	50.0 GPM	
1-1/2"	-	-	-	-	18	n/a	0.050cc	N/R	140.0 GPM	
2"	-	-	-	-	20	n/a	0.070cc	N/R	225.0 GPM	



Color Bands Part # Guide

Body Size	Description	Blue Part #	Orange Part #	Green Part #	Yellow Part #	Red Part #
1/4"	coupler band	2HTBAND-B	2HTBAND-O	2HTBAND-G	2HTBAND-Y	2HTBAND-R
1/4"	plug band	HT2BAND-B	HT2BAND-O	HT2BAND-G	HT2BAND-Y	HT2BAND-R
3/8"	coupler band	3HTBAND-B	3HTBAND-O	3HTBAND-G	3HTBAND-Y	3HTBAND-R
3/8"	plug band	HT3BAND-B	HT3BAND-O	HT3BAND-G	HT3BAND-Y	HT3BAND-R
1/2"	coupler band	4HTBAND-B	4HTBAND-O	4HTBAND-G	4HTBAND-Y	4HTBAND-R
1/2"	plug band	HT4BAND-B	HT4BAND-O	HT4BAND-G	HT4BAND-Y	HT4BAND-R
5/8"	coupler band	5HTBAND-B	5HTBAND-O	5HTBAND-G	5HTBAND-Y	5HTBAND-R
5/8"	plug band	HT5BAND-B	HT5BAND-O	HT5BAND-G	HT5BAND-Y	HT5BAND-R
3/4"	coupler band	6HTBAND-B	6HTBAND-O	6HTBAND-G	6HTBAND-Y	6HTBAND-R
3/4"	plug band	HT6BAND-B	HT6BAND-O	HT6BAND-G	HT6BAND-Y	HT6BAND-R
1"	coupler band	8HTBAND-B	8HTBAND-O	8HTBAND-G	8HTBAND-Y	8HTBAND-R
1"	plug band	HT8BAND-B	HT8BAND-O	HT8BAND-G	HT8BAND-Y	HT8BAND-R

Available Options

Body Size	Standard Seal Options						Kalrez® Seal Options			Treatments
	FKM	EPDM	FDA FKM	Mil-Nitrile	Fuel Nitrile	Silicone	4079	6375	7075	Oxy-Clean
1/4"	F-	P-	D-	M-	JF-	S-	K4-	K6-	K7-	-C1
3/8"	F-	P-	D-	M-	JF-	S-	K4-	K6-	K7-	-C1
1/2"	F-	P-	D-	M-	JF-	S-	K4-	K6-	K7-	-C1
5/8"	F-	P-	D-	M-	JF-	S-	K4-	K6-	K7-	-C1
3/4"	F-	P-	D-	M-	JF-	S-	K4-	K6-	K7-	-C1
1"	F-	P-	D-	M-	JF-	S-	K4-	K6-	K7-	-C1
1-1/2"	F-	P-	D-	M-	JF-	S-	K4-	K6-	K7-	-C1
2"	F-	P-	D-	M-	JF-	S-	K4-	K6-	K7-	-C1

HT Series Profile

Body Size	A	B
1/4"	0.64	0.22
3/8"	0.78	0.19
1/2"	0.97	0.39
5/8"	1.06	0.39
3/4"	1.18	0.45
1"	1.42	0.43

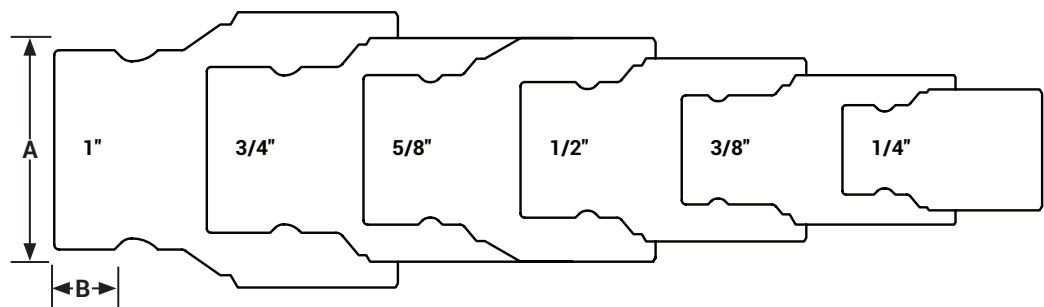

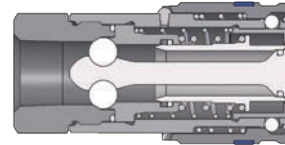

Body Size	HT-Series ISO16028 Flushface Interchange Coupler (Female Threads)								
	Part Detail			Length		Maximum O.D.		Hex inch	
	Part #	Threads	Material	inch	mm	inch	mm		
1/4"	2HTF2	1/4" - 18 NPTF	steel	1.98	50.3	1.11	28.3	7/8"	
	2HTBF2	1/4" - 19 BSPP	steel	1.98	50.3	1.11	28.3	7/8"	
	2HTOF3	9/16" - 18 ORB	steel	1.98	50.3	1.11	28.3	7/8"	
3/8"	3HTF3	3/8" - 18 NPTF	steel	2.50	63.5	1.24	31.5	1"	
	3HTF3-SS	3/8" - 18 NPTF	316 stainless	2.50	63.5	1.24	31.5	1"	
	3HTBF3	3/8" - 19 BSPP	steel	2.50	63.5	1.24	31.5	1"	
	3HTBF3-SS	3/8" - 19 BSPP	316 stainless	2.50	63.5	1.24	31.5	1"	
	3HTOF3	9/16" - 18 ORB	steel	2.50	63.5	1.24	31.5	1"	
	3HTF4	1/2" - 14 NPTF	steel	2.72	69.1	1.24	31.5	1-1/8"	
	3HTF4-SS	1/2" - 14 NPTF	316 stainless	2.72	69.1	1.24	31.5	1-1/8"	
	3HTBF4	1/2" - 14 BSPP	steel	2.72	69.1	1.24	31.5	1-1/8"	
	3HTBF4-SS	1/2" - 14 BSPP	316 stainless	2.72	69.1	1.24	31.5	1-1/8"	
1/2"	3HTOF4	3/4" - 16 ORB	steel	2.72	69.1	1.24	31.5	1-1/8"	
	4HTF4	1/2" - 14 NPTF	steel	3.02	76.7	1.54	39.1	1-3/16"	
	4HTF4-SS	1/2" - 14 NPTF	316 stainless	3.02	76.7	1.54	39.1	1-3/16"	
	4HTBF4	1/2" - 14 BSPP	steel	3.02	76.7	1.54	39.1	1-3/16"	
	4HTBF4-SS	1/2" - 14 BSPP	316 stainless	3.02	76.7	1.54	39.1	1-3/16"	
	4HTOF4	3/4" - 16 ORB	steel	3.02	76.7	1.54	39.1	1-3/16"	
	4HTOF5	7/8" - 14 ORB	steel	3.12	79.2	1.54	39.1	1-5/16"	
	4HTF6	3/4" - 14 NPTF	steel	3.22	81.8	1.54	39.1	1-5/16"	
	4HTF6-SS	3/4" - 14 NPTF	316 stainless	3.22	81.8	1.54	39.1	1-5/16"	
	4HTBF6	3/4" - 14 BSPP	steel	3.22	81.8	1.54	39.1	1-5/16"	
5/8"	4HTBF6-SS	3/4" - 14 BSPP	316 stainless	3.22	81.8	1.54	39.1	1-5/16"	
	4HTOF6	1-1/16" - 12 ORB	steel	3.42	86.9	1.54	39.1	1-5/16"	
	5HTOF5	7/8" - 14 ORB	steel	3.32	84.3	1.67	42.4	1-1/2"	
	5HTF6	3/4" - 14 NPTF	steel	3.32	84.3	1.67	42.4	1-1/2"	
	5HTF6-SS	3/4" - 14 NPTF	316 stainless	3.32	84.3	1.67	42.4	1-1/2"	
	5HTBF6	3/4" - 14 BSPP	steel	3.32	84.3	1.67	42.4	1-1/2"	
	5HTBF6-SS	3/4" - 14 BSPP	316 stainless	3.32	84.3	1.67	42.4	1-1/2"	
	5HTOF6	1-1/16" - 12 ORB	steel	3.32	84.3	1.67	42.4	1-1/2"	
	3/4"	6HTOF5	7/8" - 14 ORB	steel	3.70	94.0	1.85	47.0	1-1/2"
		6HTF6	3/4" - 14 NPTF	steel	3.70	94.0	1.85	47.0	1-1/2"
6HTF6-SS		3/4" - 14 NPTF	316 stainless	3.70	94.0	1.85	47.0	1-1/2"	
6HTBF6		3/4" - 14 BSPP	steel	3.70	94.0	1.85	47.0	1-1/2"	
6HTBF6-SS		3/4" - 14 BSPP	316 stainless	3.70	94.0	1.85	47.0	1-1/2"	
6HTOF6		1-1/16" - 12 ORB	steel	3.70	94.0	1.85	47.0	1-1/2"	
6HTF8		1" - 11-1/2 NPTF	steel	3.82	97.0	1.92	48.8	1-3/4"	
6HTF8-SS		1" - 11-1/2 NPTF	316 stainless	3.82	97.0	1.92	48.8	1-3/4"	
6HTBF8		1" - 11 BSPP	steel	3.82	97.0	1.92	48.8	1-3/4"	
6HTBF8-SS		1" - 11 BSPP	316 stainless	3.82	97.0	1.92	48.8	1-3/4"	
1"	6HTOF8	1-5/16" - 12 ORB	steel	3.82	97.0	1.92	48.8	1-3/4"	
	8HTF8	1" - 11-1/2 NPTF	steel	4.24	107.7	2.29	58.2	1-3/4"	
	8HTF8-SS	1" - 11-1/2 NPTF	316 stainless	4.24	107.7	2.29	58.2	1-3/4"	
	8HTBF8	1" - 11 BSPP	steel	4.24	107.7	2.29	58.2	1-3/4"	
	8HTBF8-SS	1" - 11 BSPP	316 stainless	4.24	107.7	2.29	58.2	1-3/4"	
	8HTOF8	1-5/16" - 12 ORB	steel	4.24	107.7	2.29	58.2	1-3/4"	
	8HTF10	1-1/4" - 11-1/2 NPTF	steel	4.34	110.2	2.29	58.2	2"	
	8HTF10-SS	1-1/4" - 11-1/2 NPTF	316 stainless	4.34	110.2	2.29	58.2	2"	
	8HTBF10	1-1/4" - 11 BSPP	steel	4.29	109.0	2.29	58.2	2"	
	8HTBF10-SS	1-1/4" - 11 BSPP	316 stainless	4.29	109.0	2.29	58.2	2"	
	8HTOF10	1-5/8" - 12 ORB	steel	4.24	107.7	2.29	58.2	2"	

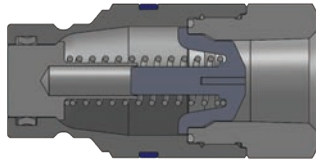

Body Size	HT-Series ISO16028 Flushface Interchange Plug (Female Threads)								
	Part Detail			Length		Maximum O.D.		Hex inch	
	Part #	Threads	Material	inch	mm	inch	mm		
1/4"	HT2F2	1/4" - 18 NPTF	steel	1.89	48.0	0.97	24.6	7/8"	
	HT2BF2	1/4" - 19 BSPP	steel	1.89	48.0	0.97	24.6	7/8"	
	HT2OF3	9/16" - 18 ORB	steel	1.89	48.0	0.97	24.6	7/8"	
3/8"	HT3F3	3/8" - 18 NPTF	steel	2.48	63.0	1.10	27.9	1"	
	HT3F3-SS	3/8" - 18 NPTF	316 stainless	2.48	63.0	1.10	27.9	1"	
	HT3BF3	3/8" - 19 BSPP	steel	2.48	63.0	1.10	27.9	1"	
	HT3BF3-SS	3/8" - 19 BSPP	316 stainless	2.48	63.0	1.10	27.9	1"	
	HT3OF3	9/16" - 18 ORB	steel	2.48	63.0	1.10	27.9	1"	
	HT3F4	1/2" - 14 NPTF	steel	2.70	68.6	1.24	31.5	1-1/8"	
	HT3F4-SS	1/2" - 14 NPTF	316 stainless	2.70	68.6	1.24	31.5	1-1/8"	
	HT3BF4	1/2" - 14 BSPP	steel	2.70	68.6	1.24	31.5	1-1/8"	
	HT3BF4-SS	1/2" - 14 BSPP	316 stainless	2.70	68.6	1.24	31.5	1-1/8"	
	HT3OF4	3/4" - 16 ORB	steel	2.70	68.6	1.24	31.5	1-1/8"	
1/2"	HT4F4	1/2" - 14 NPTF	steel	2.63	66.8	1.31	33.3	1-3/16"	
	HT4F4-SS	1/2" - 14 NPTF	316 stainless	2.63	66.8	1.31	33.3	1-3/16"	
	HT4BF4	1/2" - 14 BSPP	steel	2.63	66.8	1.31	33.3	1-3/16"	
	HT4BF4-SS	1/2" - 14 BSPP	316 stainless	2.63	66.8	1.31	33.3	1-3/16"	
	HT4OF4	3/4" - 16 ORB	steel	2.63	66.8	1.31	33.3	1-3/16"	
	HT4OF5	7/8" - 14 ORB	steel	2.63	69.3	1.31	33.3	1-5/16"	
	HT4F6	3/4" - 14 NPTF	steel	2.73	71.9	1.44	36.6	1-5/16"	
	HT4F6-SS	3/4" - 14 NPTF	316 stainless	2.83	71.9	1.44	36.6	1-5/16"	
	HT4BF6	3/4" - 14 BSPP	steel	2.83	71.9	1.44	36.6	1-5/16"	
	HT4BF6-SS	3/4" - 14 BSPP	316 stainless	2.83	71.9	1.44	36.6	1-5/16"	
	HT4OF6	1-1/16" - 12 ORB	steel	3.03	77.0	1.44	36.6	1-5/16"	
	5/8"	HT5OF5	7/8" - 14 ORB	steel	2.88	73.2	1.65	41.9	1-1/2"
		HT5F6	3/4" - 14 NPTF	steel	2.88	73.2	1.65	41.9	1-1/2"
		HT5F6-SS	3/4" - 14 NPTF	316 stainless	2.88	73.2	1.65	41.9	1-1/2"
HT5BF6		3/4" - 14 BSPP	steel	2.88	73.2	1.65	41.9	1-1/2"	
HT5BF6-SS		3/4" - 14 BSPP	316 stainless	2.88	73.2	1.65	41.9	1-1/2"	
HT5OF6		1-1/16" - 12 ORB	steel	2.88	73.2	1.65	41.9	1-1/2"	
3/4"		HT6OF5	7/8" - 14 ORB	steel	3.42	86.9	1.65	41.9	1-1/2"
	HT6F6	3/4" - 14 NPTF	steel	3.42	86.9	1.65	41.9	1-1/2"	
	HT6F6-SS	3/4" - 14 NPTF	316 stainless	3.42	86.9	1.65	41.9	1-1/2"	
	HT6BF6	3/4" - 14 BSPP	steel	3.42	86.9	1.65	41.9	1-1/2"	
	HT6BF6-SS	3/4" - 14 BSPP	316 stainless	3.42	86.9	1.65	41.9	1-1/2"	
	HT6OF6	1-1/16" - 12 ORB	steel	3.42	86.9	1.65	41.9	1-1/2"	
	HT6F8	1" - 11-1/2 NPTF	steel	3.54	89.9	1.92	48.8	1-3/4"	
	HT6F8-SS	1" - 11-1/2 NPTF	316 stainless	3.54	89.9	1.92	48.8	1-3/4"	
	HT6BF8	1" - 11 BSPP	steel	3.54	89.9	1.92	48.8	1-3/4"	
	HT6BF8-SS	1" - 11 BSPP	316 stainless	3.54	89.9	1.92	48.8	1-3/4"	
1"	HT6OF8	1-5/16" - 12 ORB	steel	3.54	89.9	1.92	48.8	1-3/4"	
	HT8F8	1" - 11-1/2 NPTF	steel	3.50	88.9	1.96	49.8	1-3/4"	
	HT8F8-SS	1" - 11-1/2 NPTF	316 stainless	3.50	88.9	1.96	49.8	1-3/4"	
	HT8BF8	1" - 11 BSPP	steel	3.50	88.9	1.96	49.8	1-3/4"	
	HT8BF8-SS	1" - 11 BSPP	316 stainless	3.50	88.9	1.96	49.8	1-3/4"	
	HT8OF8	1-5/16" - 12 ORB	steel	3.50	88.9	1.96	49.8	1-3/4"	
	HT8F10	1-1/4" - 11-1/2 NPTF	steel	3.61	91.7	2.19	55.6	2"	
	HT8F10-SS	1-1/4" - 11-1/2 NPTF	316 stainless	3.61	91.7	2.19	55.6	2"	
	HT8BF10	1-1/4" - 11 BSPP	steel	3.55	90.2	2.19	55.6	2"	
	HT8BF10-SS	1-1/4" - 11 BSPP	316 stainless	3.55	90.2	2.19	55.6	2"	
HT8OF10	1-5/8" - 12 ORB	steel	3.51	89.2	2.19	55.6	2"		

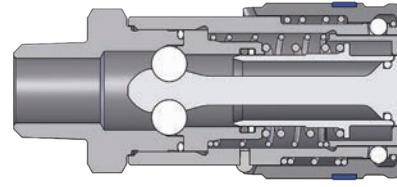

HT-Series ISO16028 Flushface Interchange Coupler (Male Threads)

Body Size	Part Detail							
	Part Detail			Length		Maximum O.D.		Hex inch
	Part #	Threads	Material	inch	mm	inch	mm	
3/8"	3HTM3	3/8" - 18 NPTF	steel	2.88	73.2	1.24	31.5	1-1/8"
	3HTM4	1/2" - 14 NPTF	steel	2.97	75.4	1.24	31.5	1-1/8"
1/2"	4HTM4	1/2" - 14 NPTF	steel	3.42	86.9	1.54	39.1	1-5/16"

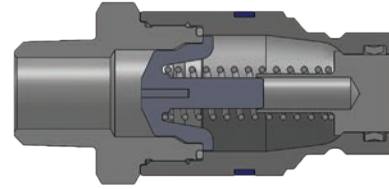

HT-Series ISO16028 Flushface Interchange Plug (Male Threads)

Body Size	Part Detail							
	Part Detail			Length		Maximum O.D.		Hex inch
	Part #	Threads	Material	inch	mm	inch	mm	
3/8"	HT3M3	3/8" - 18 NPTF	steel	2.87	72.9	1.24	31.5	1-1/8"
	HT3M4	1/2" - 14 NPTF	steel	2.96	75.2	1.24	31.5	1-1/8"
1/2"	HT4M4	1/2" - 14 NPTF	steel	3.03	77.0	1.44	36.6	1-5/16"

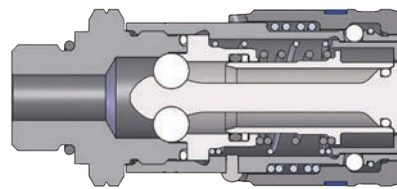

HT-Series ISO16028 Flushface Interchange Coupler (Male ORB Threads)

Body Size	Part Detail							
	Part Detail			Length		Maximum O.D.		Hex inch
	Part #	Threads	Material	inch	mm	inch	mm	
3/8"	3HTOM3	9/16" - 18 ORB	steel	2.75	69.9	1.24	31.5	1-1/8"
	3HTOM4	3/4" - 16 ORB	steel	2.75	69.9	1.24	31.5	1-1/8"

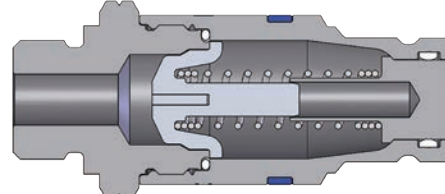

HT-Series ISO16028 Flushface Interchange Plug (Male ORB Threads)

Body Size	Part Detail							
	Part Detail			Length		Maximum O.D.		Hex inch
	Part #	Threads	Material	inch	mm	inch	mm	
3/8"	HT3OM3	9/16" - 18 ORB	steel	2.73	69.3	1.17	29.7	1-1/8"
	HT3OM4	3/4" - 16 ORB	steel	2.73	69.3	1.17	29.7	1-1/8"

Hydraulic Couplings: HT-Series Correct Connect®

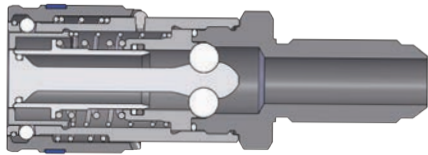

Body Size	HT-Series ISO16028 Flushface Interchange Coupler (Male Bulkhead Threads)							
	Part Detail			Length		Maximum O.D.		Hex inch
	Part #	Threads	Material	inch	mm	inch	mm	
1/2"	4HTRB4	13/16"-16 ORFS BH	steel	4.19	106.4	1.54	39.1	1-5/16"
	4HTJB5	7/8" - 14 JIC BH	steel	4.38	111.3	1.54	39.1	1-5/16"
	4HTRB5	1" - 14 ORFS BH	steel	4.37	111.0	1.54	39.1	1-5/16"
	4HTRB6	1-3/16"-12 ORFS BH	steel	4.40	111.7	1.54	39.1	1-5/16"
	4HTJB6	1-1/16" - 12 JIC BH	steel	4.55	115.6	1.54	39.1	1-5/16"

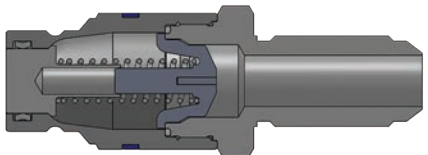

Body Size	HT-Series ISO16028 Flushface Interchange Plug (Male Bulkhead Threads)							
	Part Detail			Length		Maximum O.D.		Hex inch
	Part #	Threads	Material	inch	mm	inch	mm	
1/2"	HT4RB4	13/16"-16 ORFS BH	steel	3.83	97.2	1.44	36.5	1-5/16"
	HT4JB5	7/8" - 14 JIC BH	steel	3.99	101.3	1.44	36.6	1-5/16"
	HT4RB5	1" - 14 ORFS BH	steel	3.98	101.1	1.44	36.6	1-5/16"
	HT4RB6	1-3/16"-12 ORFS BH	steel	4.00	101.6	1.44	36.5	1-5/16"
	HT4JB6	1-1/16" - 12 JIC BH	steel	4.16	115.6	1.44	36.6	1-5/16"

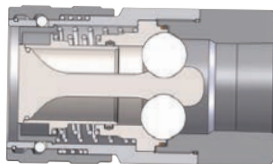

Body Size	HT-Series ISO16028 Flushface Interchange Coupler (Female Threads)							
	Part Detail			Length		Maximum O.D.		Hex inch
	Part #	Threads	Material	inch	mm	inch	mm	
1-1/2"	12HTF12	1-1/2" - 11-1/2 NPT	steel	5.23	132.7	3.37	85.5	2-1/2"
	12HTBF12	1-1/2 - 11 BSPP	steel	5.23	132.7	3.37	85.5	2-1/2"
	12HTOF12	1-7/8" - 12 ORB	steel	5.23	132.7	3.37	85.5	2-1/2"
2"	16HTF16	2" - 11-1/2 NPTF	steel	6.75	171.3	3.95	100.3	3-1/2"
	16HTBF16	2" - 11 BSPP	steel	6.75	171.3	3.95	100.3	3-1/2"
	16HTOF16	2-1/2" - 12 ORB	steel	6.75	171.3	3.95	100.3	3-1/2"

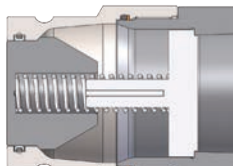

Body Size	HT-Series ISO16028 Flushface Interchange Plug (Female Threads)							
	Part Detail			Length		Maximum O.D.		Hex inch
	Part #	Threads	Material	inch	mm	inch	mm	
1-1/2"	HT12F12	1-1/2" - 11-1/2 NPT	steel	4.25	107.9	2.75	69.8	2-1/2"
	HT12BF12	1-1/2 - 11 BSPP	steel	4.25	107.9	2.75	69.8	2-1/2"
	HT12OF12	1-7/8" - 12 ORB	steel	4.25	107.9	2.75	69.8	2-1/2"
2"	HT16F16	2" - 11-1/2 NPTF	steel	4.62	117.3	3.29	83.5	3"
	HT16BF16	2" - 11 BSPP	steel	4.62	117.3	3.29	83.5	3"
	HT16OF16	2-1/2" - 12 ORB	steel	4.62	117.3	3.29	83.5	3"

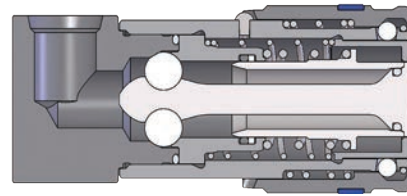

Body Size	HT-Series Flushface 90° Female Threaded Coupler							
	Part Detail			Length		Maximum O.D.		Hex inch
	Part #	Threads	Material	inch	mm	inch	mm	
1/2"	4HT9OF3	9/16"-18 ORB	steel	3.30	83.82	1.53	38.86	1-3/8"
	4HT9OF4	3/4"-16 ORB	steel	3.42	86.87	1.68	42.55	1-1/2"

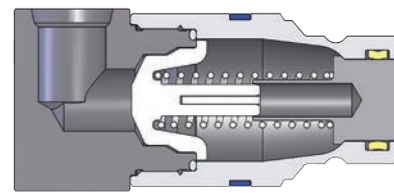

Body Size	HT-Series Flushface 90° Female Threaded Plug							
	Part Detail			Length		Maximum O.D.		Hex inch
	Part #	Threads	Material	inch	mm	inch	mm	
1/2"	HT49OF3	9/16"-18 ORB	steel	2.90	73.66	1.53	38.86	1-3/8"
	HT49OF4	3/4"-16 ORB	steel	3.03	76.96	1.68	42.67	1-1/2"

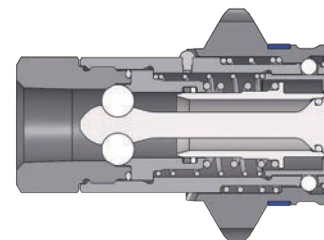
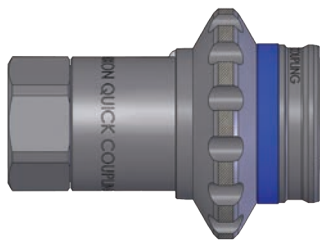

Body Size	HT-Series ISO16028 Flushface Interchange Coupler with Flange Sleeve							
	Part Detail			Length		Maximum O.D.		Hex inch
	Part #	Threads	Material	inch	mm	inch	mm	
1/4"	2HTF2-FS	1/4" - 18 NPTF	steel	1.98	50.3	1.50	38.1	7/8"
3/8"	3HTF3-FS	3/8" - 18 NPTF	steel	2.50	63.5	1.75	44.45	1"
1/2"	4HTF4-FS	1/2" - 14 NPTF	steel	3.02	76.7	2.25	57.15	1-3/16"
3/4"	6HTF6-FS	3/4" - 14 NPTF	steel	3.70	94	2.50	63.5	1-1/2"
1"	8HTF8-FS	1" - 11-1/2 NPTF	steel	4.24	107.7	2.50	63.5	1-3/4"



Body Size	HT-Series ISO16028 Flushface Plug Dust Cap		
	Part Detail		
	Part #		Body
1/4"	2HTDP		Nitrile
3/8"	3HTDP		Nitrile
1/2"	4HTDP		Nitrile
5/8"	5HTDP		Nitrile
3/4"	6HTDP		Nitrile
1"	8HTDP		Nitrile



Body Size	HT-Series ISO16028 Flushface Plug Dust Cap		
	Part Detail		
	Part #		Body
1/4"	HT2DC		Nitrile
3/8"	HT3DC		Nitrile
1/2"	HT4DC		Nitrile
5/8"	HT5DC		Nitrile
3/4"	HT6DC		Nitrile
1"	HT8DC		Nitrile

Body Size	HT-Series ISO16028 Flushface Interchange Coupler Seal Kits			
	Part Detail			Seal Kit Contents
	Part #	Coupler Style	Seal Material	
1/4"	2HT-SKIT	all	Nitrile	stem/adaptor/gland O-ring, gland B.U.
3/8"	3HT-SKIT	all	Nitrile	stem/adaptor/gland O-ring, gland B.U.
1/2"	4HT-SKIT	all	Nitrile	stem/adaptor/gland O-ring, gland B.U.
5/8"	5HT-SKIT	all	Nitrile	stem/adaptor/gland O-ring, gland B.U.
3/4"	6HT-SKIT	all	Nitrile	stem/adaptor/gland O-ring, gland B.U.
1"	8HT-SKIT	all	Nitrile	stem/adaptor/gland O-ring, gland B.U.

Body Size	HT-Series ISO16028 Flushface Interchange Plug Seal Kits			
	Part Detail			Seal Kit Contents
	Part #	Plug Style	Seal Material	
1/4"	HT2-SKIT-V2	all	Nitrile	main valve seal and adapter O-ring
3/8"	HT3-SKIT-V2	all	Nitrile	main valve seal and adapter O-ring
1/2"	HT4-SKIT-V2	all	Nitrile	main valve seal and adapter O-ring
5/8"	HT5-SKIT-V2	all	Nitrile	main valve seal and adapter O-ring
3/4"	HT6-SKIT-V2	all	Nitrile	main valve seal and adapter O-ring
1"	HT8-SKIT-V2	all	Nitrile	main valve seal and adapter O-ring

Interchange Data

- Parker FEC-Series, Stucchi APM-Series, Faster 3FFH-Series

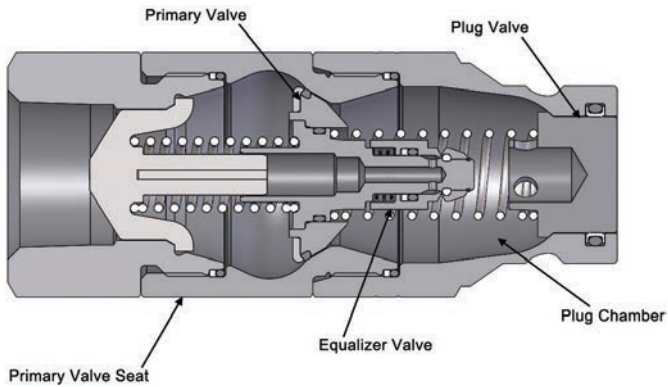
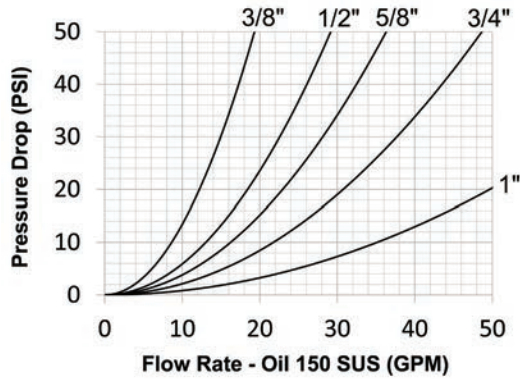

Materials

- Machined components are manufactured using solid steel bar stock
- Steel componentry is plated using a ROHS compliant zinc-nickel process providing corrosion resistance
- Stainless steel retaining rings and springs maximize corrosion resistance and extend service life
- Plugs are hardened to provide resistance to brinelling during impulse service

Seal Components

- 3/8", 1/2", 3/4", and 1" plugs have molded polyurethane valve seals, with a temperature range of -65°F to 212°F (-54°C to 100°C)
- 5/8" plugs have Nitrile-energized PTFE valve seals, with a temperature range of -40°F to 250°F (-40°C to 121°C)
- Ancillary plug seals are Nitrile with a temperature range of -40°F to 250°F (-40°C to 121°C)
- Backup rings for all sizes are PTFE

Component Terminology

- Non-linear connection force at many pressures
- No maximum connection-pressure restrictions
- Head pressure or valve bleed-by has minimal effect on connection force
- Less susceptible to system contamination
- Design is scalable performing similarly in many sizes
- Smooth connection action

Rated Pressure Chart

Body Size	HTE-Series ISO16028 Connect Under Pressure Flushface Plug											
	Steel HT Coupler/ HTE-Plug Coupled				HTE-Plug Uncoupled				Air Inclusion	Fluid Loss	Vacuum inch HG	Flow $\Delta P = 14.5$ PSI
	Max. Working		Burst		Max. Working		Burst					
	PSI	Bar	PSI	Bar	PSI	Bar	PSI	Bar				
3/8"	5,000	345	20,000	1,380	5,000	345	20,000	1,380	n/a	0.010cc	N/R	9.5 GPM
1/2"	5,000	345	20,000	1,380	5,000	345	20,000	1,380	n/a	0.010cc	N/R	15.0 GPM
5/8"	5,000	345	20,000	1,380	5,000	345	20,000	1,380	n/a	0.020cc	N/R	18.0 GPM
3/4"	5,000	345	20,000	1,380	5,000	345	20,000	1,380	n/a	0.030cc	N/R	24.0 GPM
1"	5,000	345	20,000	1,380	5,000	345	20,000	1,380	n/a	0.030cc	N/R	44.0 GPM

The Connection Process

Stage 1: The Disconnected State

The plug has residual pressure trapped behind the primary valve, while the coupler has no trapped pressure.

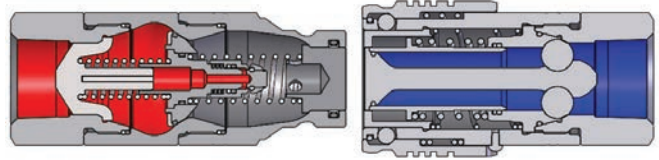

Stage 2: Plug Chamber Evacuated

The plug valve is opened, then the socket valve opens, evacuating the plug chamber to the unpressurized socket.

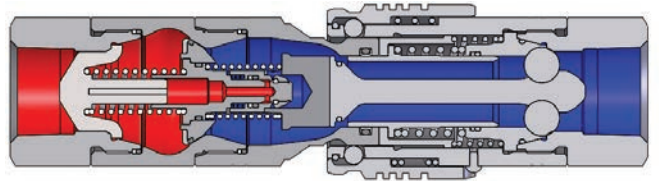

Stage 3: Release Pressure

The connection continues, with the valve being activated, releasing the trapped pressure into the plug chamber, then to the unpressurized socket.

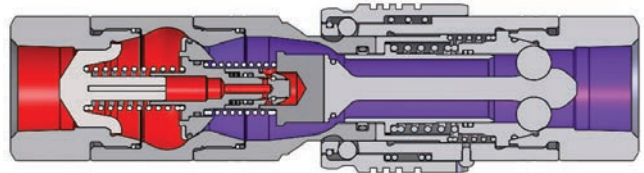

Stage 4: Complete the Connection

The primary valve can now open easily, since there is no longer any pressure trapped behind it, allowing the socket to fully engage the plug.

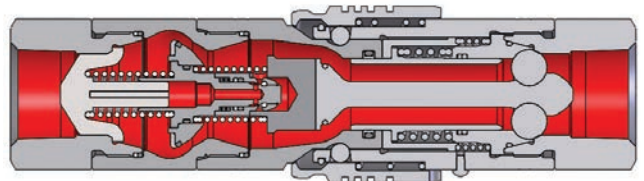

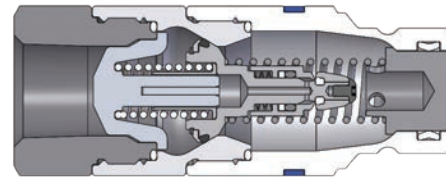

- For use with HT-Series couplers

Body Size	HTE-Series ISO 16028 Connect Under Pressure Flushface Plug (Female Threads)							
	Part Detail			Length		Maximum O.D.		Hex inch
	Part #	Threads	Material	inch	mm	inch	mm	
3/8"	HTE3F3	3/8" - 18 NPTF	steel	3.21	81.4	1.31	33.3	1-3/16"
	HTE3F4	1/2" - 14 NPTF	steel	3.25	82.6	1.30	33.0	1-1/8"
	HTE3BF4	1/2" - 14 BSPP	steel	3.25	82.6	1.30	33.0	1-1/8"
	HTE3OF4	3/4" - 16 ORB	steel	3.25	82.6	1.30	33.0	1-1/8"
1/2"	HTE4F4	1/2" - 14 NPTF	steel	3.40	86.4	1.30	33.0	1-3/16"
	HTE4BF4	1/2" - 14 BSPP	steel	3.40	86.4	1.30	33.0	1-3/16"
	HTE4OF4	3/4" - 16 ORB	steel	3.40	86.4	1.30	33.0	1-3/16"
	HTE4OF5	7/8" - 14 ORB	steel	3.40	86.4	1.30	33.0	1-1/2"
	HTE4F6	3/4" - 14 NPTF	steel	3.60	91.4	1.65	41.9	1-1/2"
	HTE4BF6	3/4" - 14 BPSS	steel	3.60	91.4	1.65	41.9	1-1/2"
	HTE4OF6	1-1/16" - 12 ORB	steel	3.60	91.4	1.65	41.9	1-1/2"
5/8"	HTE5OF5	7/8" - 14 ORB	steel	3.75	95.3	1.65	41.9	1-1/2"
	HTE5F6	3/4" - 14 NPTF	steel	3.75	95.3	1.65	41.9	1-1/2"
	HTE5BF6	3/4" - 14 BSPP	steel	3.75	95.3	1.65	41.9	1-1/2"
	HTE5OF6	1-1/16" - 12 ORB	steel	3.75	95.3	1.65	41.9	1-1/2"
3/4"	HTE6F6	3/4" - 14 NPTF	steel	4.25	108.0	1.96	49.8	1-1/2"
	HTE6BF6	3/4" - 14 BSPP	steel	4.25	108.0	1.96	49.8	1-1/2"
	HTE6OF6	1-1/16" - 12 ORB	steel	4.25	108.0	1.96	49.8	1-1/2"
	HTE6F8	1" - 11-1/2 NPTF	steel	4.40	111.8	1.96	49.8	1-3/4"
	HTE6BF8	1" - 11 BSPP	steel	4.40	111.8	1.96	49.8	1-3/4"
	HTE6OF8	1-5/16" - 12 ORB	steel	4.40	111.8	1.96	49.8	1-3/4"
1"	HTE8F8	1" - 11-1/2 NPTF	steel	4.88	124.0	1.96	49.8	1-3/4"
	HTE8BF8	1" - 11 BSPP	steel	4.88	124.0	1.96	49.8	1-3/4"
	HTE8OF8	1-5/16" - 12 ORB	steel	4.88	124.0	1.96	49.8	1-3/4"
	HTE8F10	1-1/4" - 11-1/2 NPTF	steel	5.00	127.0	2.47	62.7	2-3/16"
	HTE8BF10	1-1/4" - 11 BSPP	steel	5.00	127.0	2.47	62.7	2-3/16"
	HTE8OF10	1-5/8" - 12 ORB	steel	5.00	127.0	2.47	62.7	2-3/16"

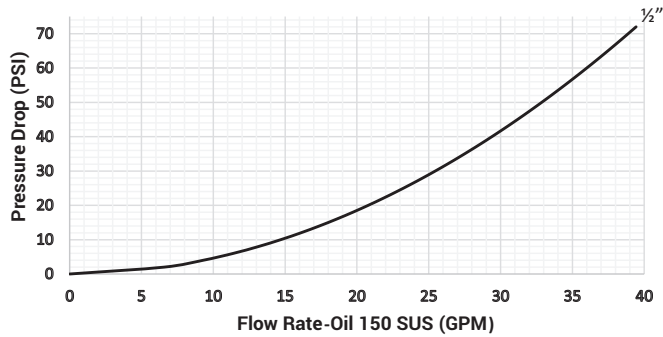

Interchange Data

- Interchangeable to ISO16028

Materials

- Machined components are manufactured using solid steel or 316 stainless steel bar stock
- Stainless steel balls, retaining rings, and springs maximize corrosion resistance and extend service life
- Steel componentry is plated using ROHS compliant zinc-nickel for corrosion resistance
- Steel coupler sleeves are hardened to resist deformation and maximize service life
- Steel plugs are hardened to provide resistance to brinelling during impulse service

Seal Components

- 1/2" plugs have molded polyurethane valve seals, with a temperature range of -65°F to 212°F (-54°C to 100°C)
- Couplers have a polyurethane valve stem O-ring, with a temperature range of -65°F to 212°F (-54°C to 100°C)
- Ancillary coupler and plug seals are Nitrile with a temperature range of -40°F to 250°F (-40°C to 121°C)
- PTFE or TPC-ET anti-extrusion ring protects main coupling valve seal from dynamic impulse pressure damage

Rated Pressure Chart

Body Size	HTZ-Series ISO16028 Flushface															
	Steel Coupler/Plug Coupled				316 SS Coupler/Plug Coupled				Steel Coupler Uncoupled				Steel Plug Uncoupled			
	Max. Working		Burst		Max. Working		Burst		Max. Working		Burst		Max. Working		Burst	
	PSI	Bar	PSI	Bar	PSI	Bar	PSI	Bar	PSI	Bar	PSI	Bar	PSI	Bar	PSI	Bar
1/2"	5,000	345	20,000	1,379	3,400	234	17,000	1,172	5,000	345	20,000	1,379	5,000	345	20,000	1,379

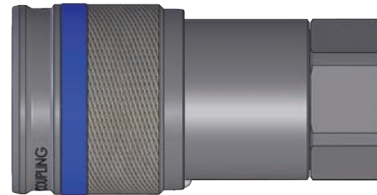
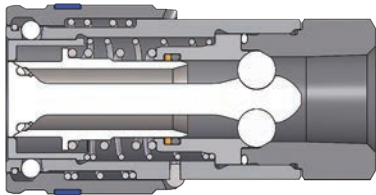

Body Size	HTZ-Series ISO16028 Connect Under Pressure Flush Face Coupler							
	Part Detail			Length		Maximum O.D.		Hex inch
	Part #	Threads	Material	inch	mm	inch	mm	
1/2"	4HTZF4	1/2" -14 NPTF	steel	3.00	76.20	1.54	39.12	1-3/16"
	4HTZF6	3/4" - 14 NPTF	steel	3.22	81.79	1.65	41.91	1-1/2"
	4HTZOF4	3/4" - 16 ORB	steel	3.00	76.20	1.54	39.12	1-3/16"
	4HTZOF5	7/8" - 14 ORB	steel	3.22	81.79	1.65	41.91	1-1/2"
	4HTZOF6	1-1/16" - 12 ORB	steel	3.22	81.79	1.65	41.91	1-1/2"

Interchange Data

- Agricultural Interchange, Parker/Pioneer 4000 Series, Faster NS/NV-Series, Safeway Series-S20, and Stucchi IR-Series
- Conforms to ISO16028 interchange standard, with Eaton/Hansen FF, Parker FEM, Faster FFH/2FFN/2FFI, Stucchi A/FIRG, and Holmbury HQ/A/FIMC

Materials

- Machined components are manufactured using solid bar stock
- Stainless steel balls, retaining rings, and springs maximize corrosion resistance and extend service life
- Steel componentry is plated using ROHS-compliant trivalent chrome
- Steel coupler sleeves are hardened to resist deformation and maximize service life

Seal Components

- HT-series couplers have polyurethane valve stem O-ring, with a temperature range of **-65° to 212°F (-54°C to 100°C)**
- Ancillary HT-series coupler seals are Nitrile with a temperature range of **-40°F to 250°F (-40°C to 121°C)**
- PTFE or TPC-ET anti-extrusion ring protects main coupling valve seal from dynamic impulse pressure damage
- Nitrile seals are standard in AG-series coupler and plug
- AG-series couplers have a PTFE anti-extrusion ring

4AGHT4 Flow Chart

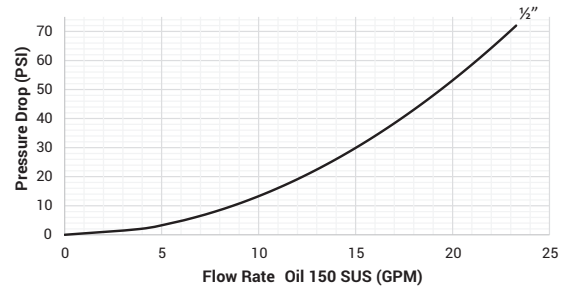

4HTAG4 Flow Chart

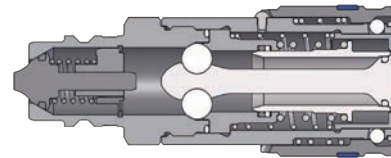
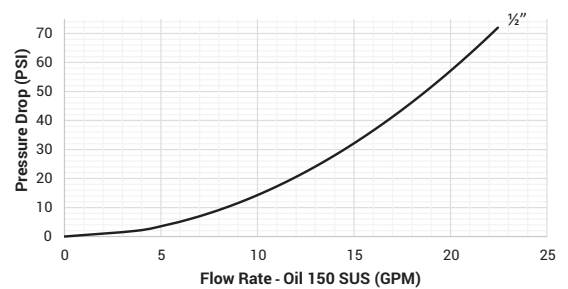

Body Size	HT-AG-Series Flushface ISO16028 Coupler x ISO7241-A AG Plug Adapter					
	Part Detail		Length		Maximum O.D.	
	Part #	Material	inch	mm	inch	mm
1/2"	4HTAG4	steel	3.89	98.81	1.57	39.88

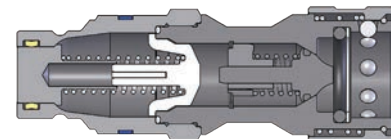

Body Size	HT-AG-Series ISO7241-A AG Coupler x ISO16028 Flushface Plug Adapter					
	Part Detail		Length		Maximum O.D.	
	Part #	Material	inch	mm	inch	mm
1/2"	4AGHT4	steel	4.15	105.41	1.51	38.35

Hydraulic Couplings: XK-Series

Interchange Data

- 10K Flushface
- Interchanges with Parker FH-Series

Materials

- Machined components are manufactured using solid bar stock
- Stainless steel balls, retaining rings, and springs maximize corrosion resistance and extend service life
- Steel componentry is plated using ROHS-compliant zinc nickel for corrosion resistance
- Steel plugs are hardened to provide resistance to brinelling

Seal Components

- Plugs have molded polyurethane valve seals, with a temperature range of **-65°F to 212°F (-54°C to 100°C)**
- Couplers have a polyurethane valve stem O-ring, with a temperature range of **-65°F to 212°F (-54°C to 100°C)**
- Ancillary coupler and plug seals are Nitrile with a temperature range of **-40°F to 250°F (-40°C to 121°C)**
- PTFE or TPC-ET anti-extrusion ring protects main coupling valve seal from dynamic impulse pressure damage

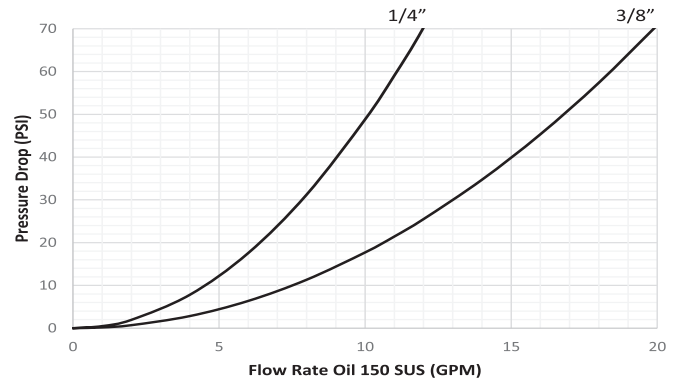

Feature

- Automatic locking mechanism

Rated Pressure Chart

Body Size	XK-Series 10K Flushface							
	Max. Working		Connected Burst		Disconnected Burst Coupler		Disconnected Burst Plug	
	PSI	Bar	PSI	Bar	PSI	Bar	PSI	Bar
1/4"	10,000	690	27,000	1,862	27,000	1,862	30,000	2,069
3/8"	10,000	690	30,000	2,068	28,000	1,930	27,000	1,860

Technical Specifications

Body Size	Interchange Standards				Functional Parameters			
	U.S. Military	U.S. Government	International Standards	ANSI/NFPA Standards	Air Inclusion	Fluid Loss	Vacuum inch HG	Flow $\Delta P = 15$ PSI
1/4"	-	-	-	-	n/a	0.010cc	N/R	5.5 GPM
3/8"	-	-	-	-	n/a	0.010cc	N/R	9.2 GPM

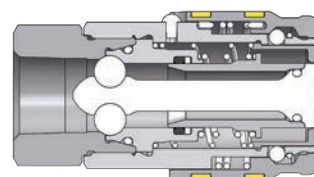

Body Size	XK-Series 10K Flushface Coupler (Female Threads)							
	Part Detail			Length		Maximum O.D.		Hex inch
	Part #	Threads	Material	inch	mm	inch	mm	
1/4"	2XKF2	1/4" - 18 NPTF	steel	2.10	53	1.16"	30	7/8"
3/8"	3XKF3	3/8" - 18 NPTF	steel	2.41	61.21	1.31	33.27	1"

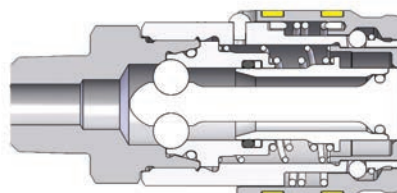

Body Size	XK-Series 10K Flushface Coupler (Male Threads)							
	Part Detail			Length		Maximum O.D.		Hex inch
	Part #	Threads	Material	inch	mm	inch	mm	
1/4"	2XKM2	1/4" - 18 NPTF	steel	2.38"	60	1.16"	30	7/8"
3/8"	3XKM3	3/8" - 18 NPTF	steel	2.77"	70	1.31"	33	1"

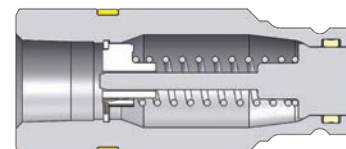

Body Size	XK-Series 10K Flushface Plug (Female Threads)							
	Part Detail			Length		Maximum O.D.		Hex inch
	Part #	Threads	Material	inch	mm	inch	mm	
1/4"	XK2F2	1/4" - 18 NPTF	steel	2.15	55	0.92"	23	7/8"
3/8"	XK3F3	3/8" - 18 NPTF	steel	2.50	63.5	1.07	27.18	1"

Hydraulic Couplings: ST-Series

Interchange Data

- Interchangeable with Parker/Snap-Tite 71-Series

Materials

- Machined components are manufactured using solid steel or 316 stainless bar stock
- Stainless steel balls, retaining rings, and springs maximize corrosion resistance and extend service life
- Steel componentry is plated using ROHS-compliant trivalent chrome
- Steel coupler sleeves are hardened to resist deformation and maximize service life
- Steel plugs are hardened to provide heavy-duty performance

Seal Components

- Nitrile seals are standard, providing a temperature range of -40°F to 250°F (-40°C to 121°C)
- All couplers and plugs incorporate PTFE anti-extrusion rings to protect the seal components from dynamic impulse damage

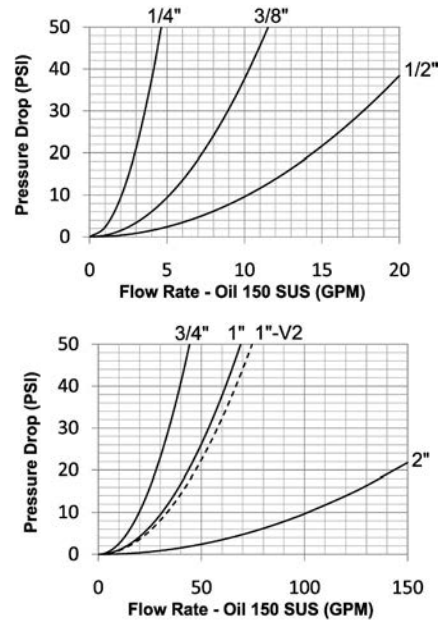

Rated Pressure Chart

Body Size	ST-Series Heavy-Duty Flushface							
	Steel Coupler/Plug Coupled				316 Stainless Coupler/Plug Coupled			
	Maximum Working		Burst		Maximum Working		Burst	
	PSI	Bar	PSI	Bar	PSI	Bar	PSI	Bar
1/4"	10,000	700	27,300	1,800	5,000	345	28,000	1,900
3/8"	10,000	700	27,300	1,800	5,000	345	28,000	1,900
1/2"	10,000	700	22,500	1,500	5,000	345	25,000	1,700
3/4"	7,500	500	20,200	1,400	5,000	345	22,800	1,550
1"	7,500	500	19,400	1,300	4,000	275	18,500	1,250
1"-V2	8,500	585	25,900	1,750	-	-	-	-
2"	5,000	345	16,000	1,100	3,000	200	10,000	700

Technical Specifications

Body Size	Interchange Standards				Functional Parameters				
	U.S. Military	U.S. Government	International Standards	ANSI/NFPA Standards	Locking Ball Quantity	Air Inclusion	Fluid Loss	Vacuum inch HG	Flow ΔP = 22 PSI
1/4"	-	-	-	-	10	0.01cc	0.02cc	N/R	3.1 GPM
3/8"	-	-	-	-	10	0.02cc	0.02cc	N/R	7.7 GPM
1/2"	-	-	-	-	12	0.03cc	0.03cc	N/R	15.0 GPM
3/4"	-	-	-	-	12	0.04cc	0.06cc	N/R	30.0 GPM
1"	-	-	-	-	12	0.06cc	0.07cc	N/R	45.0 GPM
1"-V2	-	-	-	-	12	0.09cc	0.10cc	N/R	50.0 GPM
2"	-	-	-	-	15	3.14cc	5.25cc	N/R	150.0 GPM

Available Options

Body Size	Standard Seal Options				Kalrez® Seal Options			Sleeve	Treatments
	FKM	EPDM	Mil-Nitrile	Fuel Nitrile	4079	6375	7075	Locking	Oxy-Clean
1/4"	F-	P-	M-	JF-	K4-	K6-	K7-	-LS	-C1
3/8"	F-	P-	M-	JF-	K4-	K6-	K7-	-LS	-C1
1/2"	F-	P-	M-	JF-	K4-	K6-	K7-	-LS	-C1
3/4"	F-	P-	M-	JF-	K4-	K6-	K7-	-LS	-C1
1"	F-	P-	M-	JF-	K4-	K6-	K7-	-LS	-C1
1"-V2	F-	P-	M-	JF-	K4-	K6-	K7-	-LS	-C1
2"	F-	P-	M-	JF-	K4-	K6-	K7-	-LS	-C1

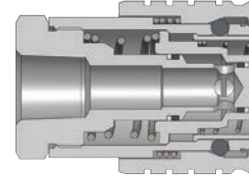
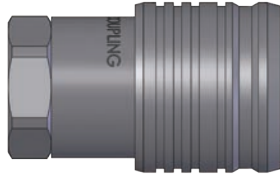

ST-Series Heavy-Duty Flushface Coupler (Female Threads)

Body Size	ST-Series Heavy-Duty Flushface Coupler (Female Threads)							
	Part Detail			Length		Maximum O.D.		Hex inch
	Part #	Threads	Material	inch	mm	inch	mm	
1/4"	2STF2	1/4" - 18 NPTF	steel	1.96	49.8	1.23	31.2	15/16"
	2STF2-SS	1/4" - 18 NPTF	316 stainless	1.96	49.8	1.23	31.2	15/16"
	2STBF2	1/4" - 19 BSPP	steel	1.96	49.8	1.23	31.2	15/16"
	2STBF2-SS	1/4" - 19 BSPP	316 stainless	1.96	49.8	1.23	31.2	15/16"
3/8"	3STF2	1/4" - 18 NPTF	steel	2.36	59.9	1.60	40.6	1-3/16"
	3STF3	3/8" - 18 NPTF	steel	2.36	59.9	1.60	40.6	1-3/16"
	3STF3-SS	3/8" - 18 NPTF	316 stainless	2.36	59.9	1.60	40.6	1-3/16"
	3STBF3	3/8" - 19 BSPP	steel	2.36	59.9	1.60	40.6	1-3/16"
	3STBF3-SS	3/8" - 19 BSPP	316 stainless	2.36	59.9	1.60	40.6	1-3/16"
	3STF4	1/2" - 14 NPTF	steel	2.36	59.9	1.60	40.6	1-3/16"
	3STF4-SS	1/2" - 14 NPTF	316 stainless	2.36	59.9	1.60	40.6	1-3/16"
	3STBF4	1/2" - 14 BSPP	steel	2.36	59.9	1.60	40.6	1-3/16"
1/2"	3STBF4-SS	1/2" - 14 BSPP	316 stainless	2.36	59.9	1.60	40.6	1-3/16"
	4STF4	1/2" - 14 NPTF	steel	2.77	70.4	1.98	50.3	1-1/2"
	4STF4-SS	1/2" - 14 NPTF	316 stainless	2.77	70.4	1.98	50.3	1-1/2"
	4STBF4	1/2" - 14 BSPP	steel	2.77	70.4	1.98	50.3	1-1/2"
	4STBF4-SS	1/2" - 14 BSPP	316 stainless	2.77	70.4	1.98	50.3	1-1/2"
3/4"	4STOF4	3/4" - 16 ORB	steel	2.77	70.4	1.98	50.3	1-1/2"
	6STF6	3/4" - 14 NPTF	steel	3.03	77.0	2.35	59.7	1-3/4"
	6STF6-SS	3/4" - 14 NPTF	316 stainless	3.03	77.0	2.35	59.7	1-3/4"
	6STBF6	3/4" - 14 BSPP	steel	3.03	77.0	2.35	59.7	1-3/4"
	6STBF6-SS	3/4" - 14 BSPP	316 stainless	3.03	77.0	2.35	59.7	1-3/4"
1"	6STOF6	1-1/16" - 12 ORB	steel	3.03	77.0	2.35	59.7	1-3/4"
	8STF8	1" - 11-1/2 NPTF	steel	3.33	84.6	2.73	69.3	2"
	8STF8-SS	1" - 11-1/2 NPTF	316 stainless	3.33	84.6	1.55	39.3	2"
	8STBF8	1" - 11 BSPP	steel	3.33	84.6	2.73	69.3	2"
	8STBF8-SS	1" - 11 BSPP	316 stainless	3.33	84.6	2.73	69.3	2"
	8STOF8	1-5/16" - 12 ORB	steel	3.33	84.6	2.73	69.3	2"
	8STF10	1-1/4" - 11-1/2 NPTF	steel	3.67	93.2	2.73	69.3	2"
	8STF10-SS	1-1/4" - 11-1/2 NPTF	316 stainless	3.67	93.2	2.73	69.3	2"
	8STBF10	1-1/4" - 11 BSPP	steel	3.67	93.2	2.73	69.3	2"
	8STBF10-SS	1-1/4" - 11 BSPP	316 stainless	3.67	93.2	2.73	69.3	2"
	8STOF10	1-5/8" - 12 ORB	steel	3.67	93.2	2.73	69.3	2"

Hydraulic Couplings: ST-Series

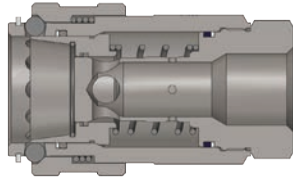

Body Size	ST-Series Heavy-Duty Flushface Coupler (Female Threads)							
	Part Detail			Length		Maximum O.D.		Hex inch
	Part #	Threads	Material	inch	mm	inch	mm	
2"	16STF12	1-1/2" - 11-1/2 NPTF	steel	6.20	157.5	4.47	113.5	3.78"
	16STBF12	1-1/2" - 11 BSPP	steel	6.20	157.5	4.47	113.5	3.78"
	16STOF12	1-7/8" - 12 ORB	steel	6.20	157.5	4.47	113.5	3.78"
	16STF16	2" - 11-1/2 NPTF	steel	6.20	157.5	4.47	113.5	3.78"
	16STF16-SS	2" - 11-1/2 NPTF	316 stainless	6.20	157.5	4.47	113.5	3.78"
	16STBF16	2" - 11 BSPP	steel	6.20	157.5	4.47	113.5	3.78"
	16STOF16	2-1/2" - 12 ORB	steel	6.20	157.5	4.47	113.5	3.78"

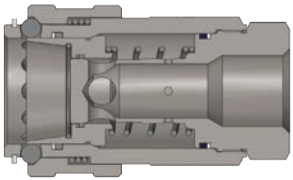

Body Size	ST-Series Heavy-Duty Flushface 'Old Style' Coupler (Female Threads)							
	Part Detail			Length		Maximum O.D.		Hex inch
	Part #	Threads	Material	inch	mm	inch	mm	
1"	8STF8-V2	1" - 11-1/2 NPTF	steel	4.55	115.6	2.74	69.6	2"
	8STBF8-V2	1" - 11 BSPP	steel	4.55	115.6	2.74	69.6	2"
	8STF10-V2	1-1/4" - 11-1/2 NPTF	steel	4.90	124.5	2.74	69.6	2"

ST-Series Profiles

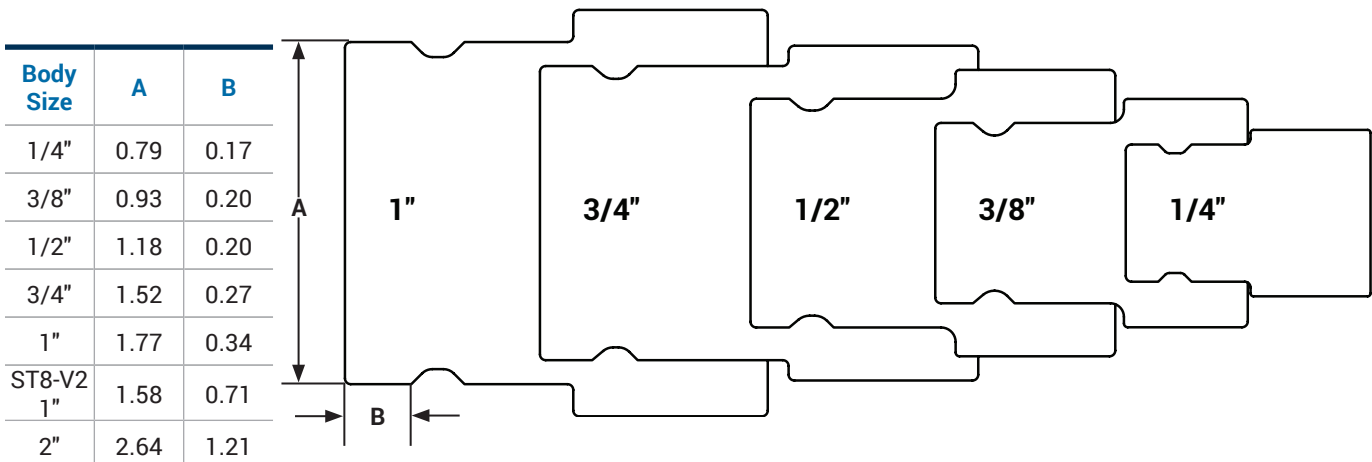

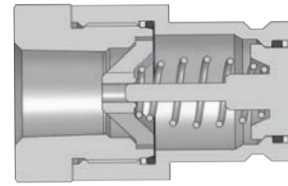

Body Size	ST-Series Heavy-Duty Flushface Plug (Female Threads)							
	Part Detail			Length		Maximum O.D.		Hex inch
	Part #	Threads	Material	inch	mm	inch	mm	
1/4"	ST2F2	1/4" - 18 NPTF	steel	1.84	46.7	0.90	22.9	13/16"
	ST2F2-SS	1/4" - 18 NPTF	316 stainless	1.84	46.7	0.90	22.9	13/16"
	ST2BF2	1/4" - 19 BSPP	steel	1.84	46.7	0.90	22.9	13/16"
	ST2BF2-SS	1/4" - 19 BSPP	316 stainless	1.84	46.7	0.90	22.9	13/16"
3/8"	ST3F2	1/4" - 18 NPTF	steel	2.32	58.9	1.48	37.6	1"
	ST3F3	3/8" - 18 NPTF	steel	2.32	58.9	1.48	37.6	1"
	ST3F3-SS	3/8" - 18 NPTF	316 stainless	2.32	58.9	1.48	37.6	1"
	ST3BF3	3/8" - 19 BSPP	steel	2.32	58.9	1.48	37.6	1"
	ST3BF3-SS	3/8" - 19 BSPP	316 stainless	2.32	58.9	1.48	37.6	1"
	ST3F4	1/2" - 14 NPTF	steel	2.32	58.9	1.48	37.6	1"
	ST3F4-SS	1/2" - 14 NPTF	316 stainless	2.32	58.9	1.48	37.6	1"
	ST3BF4	1/2" - 14 BSPP	steel	2.32	58.9	1.48	37.6	1"
1/2"	ST3BF4-SS	1/2" - 14 BSPP	316 stainless	2.32	58.9	1.48	37.6	1"
	ST4F4	1/2" - 14 NPTF	steel	2.37	60.2	1.65	41.9	1-1/2"
	ST4F4-SS	1/2" - 14 NPTF	316 stainless	2.37	60.2	1.65	41.9	1-1/2"
	ST4BF4	1/2" - 14 BSPP	steel	2.37	60.2	1.65	41.9	1-1/2"
	ST4BF4-SS	1/2" - 14 BSPP	316 stainless	2.37	60.2	1.65	41.9	1-1/2"
3/4"	ST4OF4	3/4" - 16 ORB	steel	2.37	60.2	1.65	41.9	1-1/2"
	ST6F6	3/4" - 14 NPTF	steel	2.96	75.2	1.92	48.8	1-3/4"
	ST6F6-SS	3/4" - 14 NPTF	316 stainless	2.96	75.2	1.92	48.8	1-3/4"
	ST6BF6	3/4" - 14 BSPP	steel	2.96	75.2	1.92	48.8	1-3/4"
	ST6BF6-SS	3/4" - 14 BSPP	316 stainless	2.96	75.2	1.92	48.8	1-3/4"
1"	ST6OF6	1-1/16" - 12 ORB	steel	2.96	75.2	1.92	48.8	1-3/4"
	ST8F8	1" - 11-1/2 NPTF	steel	3.22	81.8	2.10	53.3	1-7/8"
	ST8F8-SS	1" - 11-1/2 NPTF	316 stainless	3.22	81.8	2.10	53.3	1-7/8"
	ST8BF8	1" - 11 BSPP	steel	3.22	81.8	2.10	53.3	1-7/8"
	ST8BF8-SS	1" - 11 BSPP	316 stainless	3.22	81.8	2.10	53.3	1-7/8"
	ST8OF8	1-5/16" - 12 ORB	steel	3.22	81.8	2.10	53.3	1-7/8"
	ST8F10	1-1/4" - 11-1/2 NPTF	steel	3.48	88.4	2.20	55.9	2"
	ST8F10-SS	1-1/4" - 11-1/2 NPTF	316 stainless	3.48	88.4	2.20	55.9	2"
	ST8BF10	1-1/4" - 11 BSPP	steel	3.48	88.4	2.20	55.9	2"
	ST8BF10-SS	1-1/4" - 11 BSPP	316 stainless	3.48	88.4	2.20	55.9	2"
	ST8OF10	1-5/8" - 12 ORB	steel	3.48	88.4	2.20	55.9	2"

Hydraulic Couplings: ST-Series

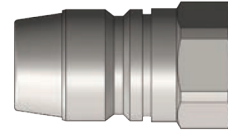
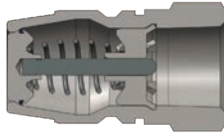

Body Size	ST-Series Heavy-Duty Flushface Plug (Female Threads)							
	Part Detail			Length		Maximum O.D.		Hex inch
	Part #	Threads	Material	inch	mm	inch	mm	
2"	ST16F12	1-1/2" - 11-1/2 NPTF	steel	4.50	114.3	3.48	88.4	3-1/4"
	ST16BF12	1-1/2" - 11 BSPP	steel	4.50	114.3	3.48	88.4	3-1/4"
	ST16OF12	1-7/8" - 12 ORB	steel	4.50	114.3	3.48	88.4	3-1/4"
	ST16F16	2" - 11-1/2 NPTF	steel	4.50	114.3	3.48	88.4	3-1/4"
	ST16F16-SS	2" - 11-1/2 NPTF	316 stainless	4.50	114.3	3.48	88.4	3-1/4"
	ST16BF16	2" - 11 BSPP	steel	4.50	114.3	3.48	88.4	3-1/4"
	ST16OF16	2-1/2" - 12 ORB	steel	4.50	114.3	3.48	88.4	3-1/4"

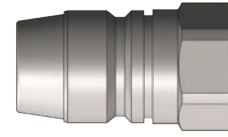
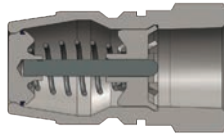

Body Size	ST-Series Heavy-Duty Flushface 'Old Style' Plug (Female Threads)							
	Part Detail			Length		Maximum O.D.		Hex inch
	Part #	Threads	Material	inch	mm	inch	mm	
1"	ST8F8-V2	1" - 11-1/2 NPTF	steel	3.26	82.8	1.92	48.8	1-3/4"
	ST8BF8-V2	1" - 11 BSPP	steel	3.26	82.8	1.92	48.8	1-3/4"
	ST8F10-V2	1-1/4" - 11-1/2 NPTF	steel	3.50	88.9	1.98	50.3	2"



Body Size	ST-Series Coupler Dust Plug			
	Part Detail			
	Part #	Lanyard	Body	
1/4"	2STDP-A	steel cable	aluminum	
3/8"	3STDP-A	steel cable	aluminum	
1/2"	4STDP-A	steel cable	aluminum	
3/4"	6STDP-A	steel cable	aluminum	
1"	8STDP-A	steel cable	aluminum	
1"-V2	8STDP-A-V2	steel cable	aluminum	
2"	16STDP-A	steel cable	aluminum	

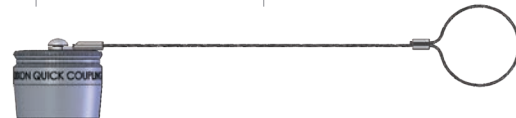

Body Size	ST-Series Plug Dust Cap			
	Part Detail			
	Part #	Lanyard	Body	
1/4"	ST2DC-A	steel cable	aluminum	
3/8"	ST3DC-A	steel cable	aluminum	
1/2"	ST4DC-A	steel cable	aluminum	
3/4"	ST6DC-A	steel cable	aluminum	
1"	ST8DC-A	steel cable	aluminum	
1"-V2	ST8DC-A-V2	steel cable	aluminum	
2"	ST16DC-A	steel cable	aluminum	

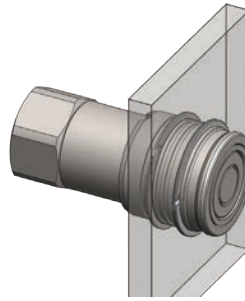

Body Size	ST-Series Heavy-Duty Flushface Coupler Bulkhead Kits			
	Part Detail			Bulkhead Kit Contents
	Part #	Mounting Hole ID	Ring Material	
1/4"	2ST-BMK	1.250"	steel	two 360° retaining rings
3/8"	3ST-BMK	1.625"	steel	two 360° retaining rings
1/2"	4ST-BMK	2.000"	steel	two 360° retaining rings
3/4"	6ST-BMK	2.375"	steel	two 360° retaining rings

Body Size	ST-Series Heavy-Duty Flushface Coupler Seal Kits			
	Part Detail			Seal Kit Contents
	Part #	Coupler Style	Seal Material	
1/4"	2ST-SKIT	all	Nitrile	two seals and anti-extrusion rings
3/8"	3ST-SKIT	all	Nitrile	two seals and anti-extrusion rings
1/2"	4ST-SKIT	all	Nitrile	two seals and anti-extrusion rings
3/4"	6ST-SKIT	all	Nitrile	two seals and anti-extrusion rings
1"	8ST-SKIT	all	Nitrile	two seals and anti-extrusion rings
1"	8ST-SKIT-V2	all	Nitrile	three seals and two anti-extrusion rings
2"	16ST-SKIT	all	Nitrile	three seals and two anti-extrusion rings

Body Size	ST-Series Heavy-Duty Flushface Plug Seal Kits			
	Part Detail			Seal Kit Contents
	Part #	Coupler Style	Seal Material	
1/4"	ST2-SKIT	all	Nitrile	valve O-ring/back-up and adapter O-ring
3/8"	ST3-SKIT	all	Nitrile	valve O-ring/back-up and adapter O-ring
1/2"	ST4-SKIT	all	Nitrile	valve O-ring/back-up and adapter O-ring
3/4"	ST6-SKIT	all	Nitrile	valve O-ring/back-up and adapter O-ring
1"	ST8-SKIT	all	Nitrile	valve O-ring/back-up and adapter O-ring
2"	ST16-SKIT	all	Nitrile	main valve seal

Hydraulic Couplings: PD-Series

Interchange Data

- Interchangeable to ISO15171-1
- Parker PD-Series, Eaton/Aeroquip FD90

Materials

- Machined components are manufactured using solid steel bar stock
- Stainless steel springs. Carbon steel balls and retaining rings
- Steel plugs are machined from solid steel bar stock and hardened
- Steel componentry is plated using ROHS-compliant trivalent chrome

Seal Components

- Nitrile seals are standard, providing a temperature range of -40°F to 250°F (-40°C to 121°C)
- PTFE anti-extrusion ring protects main coupler O-ring from dynamic impulse pressure damage

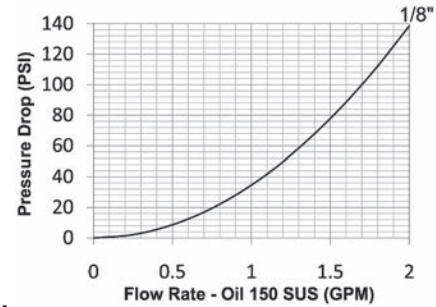

Rated Pressure Chart

Body Size	PD-Series ISO15171-1 Diagnostic Interchange							
	Steel Coupler/Plug Connected				Steel Plug Disconnected			
	Maximum Working		Burst		Maximum Working		Burst	
	PSI	Bar	PSI	Bar	PSI	Bar	PSI	Bar
1/8"	6,000	400	18,700	1,300	6,000	400	24,000	1,600

Technical Specifications

Body Size	Interchange Standards				Functional Parameters				
	U.S. Military	U.S. Government	International Standards	ANSI/NFPA Standards	Locking Ball Quantity	Air Inclusion	Fluid Loss	Vacuum Rating	Flow ΔP = 22 PSI
1/8"	-	-	ISO15171-1	SAE J1502	10	0.02	0.1	27.4	0.8 GPM

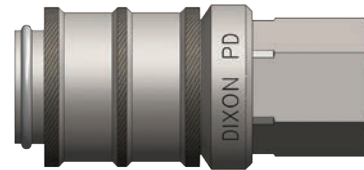
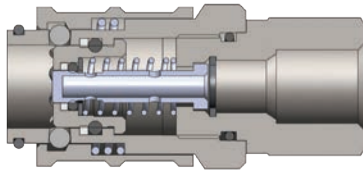

Body Size	PD-Series ISO15171-1 Diagnostic Coupler (Female Threads)							
	Part Detail			Length		Maximum O.D.		Hex mm
	Part #	Threads	Material	inch	mm	inch	mm	
1/8"	1PDF1	1/8" - 27 NPT	steel	2.13	54.1	0.98	24.8	21
	1PDF2	1/4" - 18 NPT	steel	2.13	54.1	0.98	24.8	21

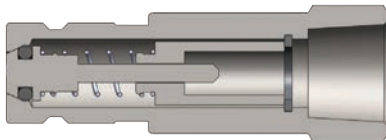

Body Size	PD-Series ISO15171-1 Diagnostic Plug (Female Threads)							
	Part Detail			Length		Maximum O.D.		Hex mm
	Part #	Threads	Material	inch	mm	inch	mm	
1/8"	PD1F1	1/8" - 27 NPT	steel	1.88	47.7	0.76	19.3	17
	PD1F2	1/4" - 18 NPT	steel	1.88	47.7	0.76	19.3	17

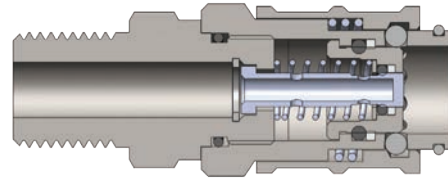

Body Size	PD-Series ISO15171-1 Diagnostic Coupler (Male Threads)							
	Part Detail			Length		Maximum O.D.		Hex mm
	Part #	Threads	Material	inch	mm	inch	mm	
1/8"	1PDM2	1/4" - 18 NPT	steel	2.28	57.9	0.98	24.9	21

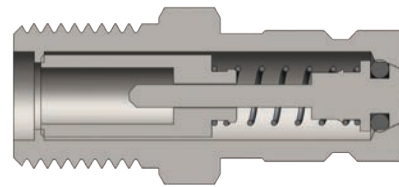

Body Size	PD-Series ISO15171-1 Diagnostic Plug (Male Threads)							
	Part Detail			Length		Maximum O.D.		Hex mm
	Part #	Threads	Material	inch	mm	inch	mm	
1/8"	PD1M1	1/8" - 27 NPT	steel	1.98	50.2	0.76	19.3	17
	PD1M2	1/4" - 18 NPT	steel	1.48	37.5	0.76	19.3	17

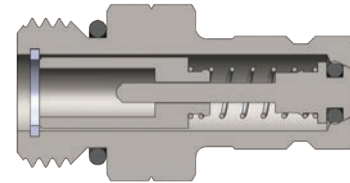

Body Size	PD-Series ISO15171-1 Diagnostic Plug (Male ORB Threads)							
	Part Detail			Length		Maximum O.D.		Hex mm
	Part #	Threads	Material	inch	mm	inch	mm	
1/8"	PD10M2	7/16" - 20 ORB	steel	1.93	49.0	0.76	19.3	17
	PD10M3	9/16" - 18 ORB	steel	1.48	37.5	0.76	19.3	17

Body Size	PD-Series Plug Dust Cap	
	Part Detail	
	Part #	Material
1/8"	H1DC	Nitrile

PD-Series Profile

Body Size	A	B
1/8"	0.49	0.19

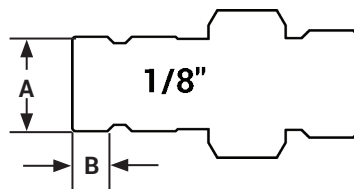

Hydraulic Couplings: VEP-Series

Interchange Data

- Stucchi VEP-P/VEP-HD Series, DNP PST4/FSI Series, Voswinkel FT Series, Parker FET-Series, and Holmbury HFT Series

Seal Components

- Plugs have Nitrile-energized PTFE valve seals, with a temperature range of **-40°F to 250°F (-40°C to 121°C)**
- 3/8" plugs have molded polyurethane valve seals, with a temperature range of **-65°F to 212°F (-54°C to 100°C)**
- 3/8" to 3/4" valve stems have molded acetal seals, with a temperature range of **-65°F to 212°F (-54°C to 100°C)**
- 1" to 2" valve stems have molded polyurethane seals, with a temperature range of **-65°F to 212°F (-54°C to 100°C)**
- Ancillary coupler and plug seals are Nitrile with a temperature range of **-40°F to 250°F (-40°C to 121°C)**
- TPC-ET anti-extrusion ring protects main coupling valve seal from dynamic impulse pressure damage

Materials

- Machined components are manufactured using solid steel bar stock
- Stainless steel retaining rings and springs maximize corrosion resistance and extend service life
- Steel componentry is plated using ROHS compliant zinc nickel for corrosion resistance

Two-stage valving to protect critical sealing components during pressurized connection and disconnection

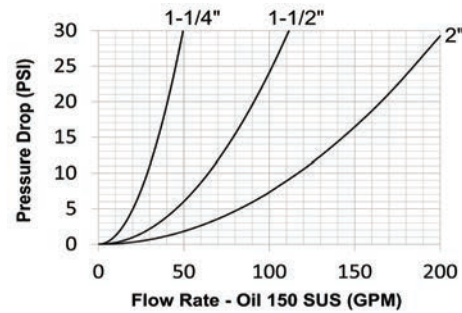
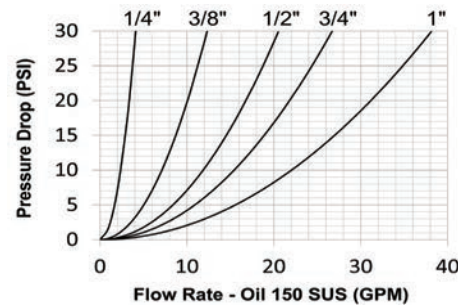
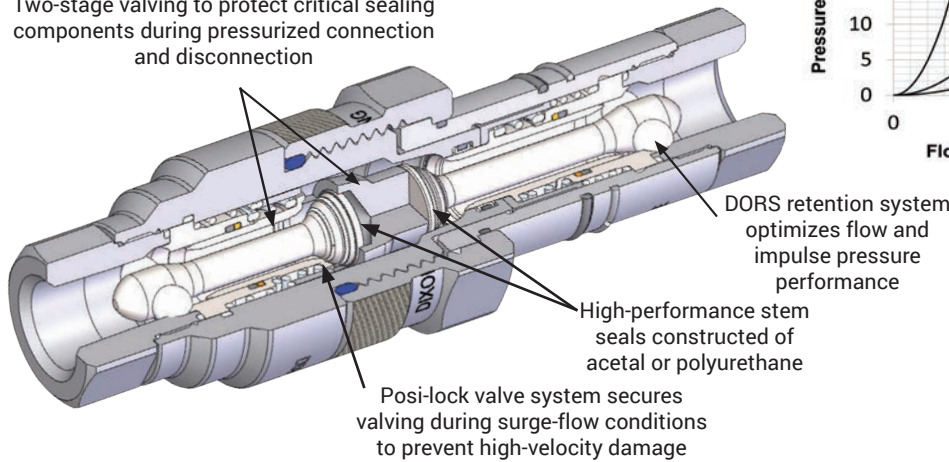

Rated Pressure Chart

VEP-Series Interchange

Body Size	Pressure Rating				Burst Pressure						Max. Pressure Connect ³		Max. Pressure Disconnect ³		Rated Flow ΔP=21.75 PSI	
	ISO Working ¹		Max. Impulse ²		Connected		Coupler		Plug		PSI	Bar	PSI	Bar	GPM	L/min
	PSI	Bar	PSI	Bar	PSI	Bar	PSI	Bar	PSI	Bar	PSI	Bar	PSI	Bar		
1/4"	6,000	400	9,000	625	24,000	1,650	22,000	1,525	22,000	1,525	5,500	375	5,500	375	3.5	13
3/8"	5,500	375	8,000	550	22,000	1,525	18,000	1,250	20,000	1,375	4,500	300	4,500	300	10.5	40
1/2"	5,500	375	8,000	550	22,000	1,525	18,000	1,250	20,000	1,375	4,500	300	4,500	300	17.5	66
3/4"	5,500	375	8,000	550	22,000	1,525	18,000	1,250	20,000	1,375	4,500	300	4,500	300	22.7	85
1"	5,500	375	7,500	525	22,000	1,525	14,500	1,000	20,000	1,375	3,625	250	3,625	250	32.5	123
1-1/4"	5,000	350	7,000	475	20,000	1,375	14,500	1,000	16,000	1,100	3,625	250	3,625	250	46.4	174
1-1/2"	4,500	300	5,800	400	18,000	1,250	12,000	8,325	14,500	1,000	3,000	200	3,000	200	95.0	360
2"	4,000	275	5,000	350	18,000	1,250	12,000	8,325	14,500	1,000	3,000	200	3,000	200	172.5	653

¹Couplings impulse tested in accordance with ISO18869 for 1,000,000 cycles connected and 100,000 cycles disconnected at 133% of ISO working pressure.

²Couplings impulse tested in accordance with ISO18869 for 100,000 cycles connected and disconnected at maximum impulse pressure listed

³System temperature for maximum connect/disconnect pressure must not exceed **150°F (65°C)**

How to Connect and Disconnect the VEP-Series Coupling

1. Prior to connecting, thoroughly clean all mating surfaces and threads on both halves, then pull the coupler sleeve forward.
2. To initiate the connection, align the coupler and plug, pushing/turning the coupler sleeve toward the plug while engaging the threads. Keep the mating halves aligned during the connection process.
3. Allow the threads to pull the coupler onto the plug; do not push the coupler onto the plug.
4. The first phase of the connection should be threaded by hand, without the use of tools. Please note the connection sleeve may seize when dirt and debris accumulate in the threads - remove debris with a cloth, compressed air, or a brush.
5. The second phase of the connection may require a wrench if the pressure is higher than anticipated.
6. Continue to thread the coupler sleeve onto the plug until the end of the sleeve meets the plug body
7. To disconnect, use a wrench to break the coupler sleeve free and keep the mating halves aligned during the disconnection process.

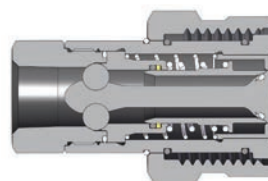
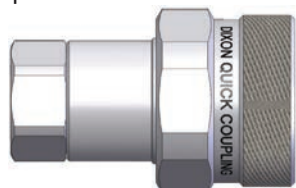

Body Size	VEP-Series Coupler (Female Threads)							
	Part Detail			Length		Maximum O.D.		Hex mm
	Part #	Threads	Materials	inch	mm	inch	mm	
1/4"	2VEPF2	1/4" - 18 NPTF	steel	2.14	54.4	1.49	37.8	22
	2VEPBF2	1/4" - 19 BSPP	steel	2.14	54.4	1.49	37.8	22
	2VEPOF3	9/16" - 18 ORB	steel	2.14	54.4	1.49	37.8	22
3/8"	3VEPF3	3/8" - 18 NPTF	steel	2.55	64.8	1.62	41.1	25
	3VEPBF3	3/8" - 19 BSPP	steel	2.55	64.8	1.62	41.1	25
	3VEPOF4	3/4" - 16 ORB	steel	2.77	70.4	1.62	41.1	25
	3VEPF4	1/2" - 14 NPTF	steel	2.77	70.4	1.62	41.1	28
	3VEPBF4	1/2" - 14 BSPP	steel	2.77	70.4	1.62	41.1	28
1/2"	4VEPF4	1/2" - 14 NPTF	steel	3.08	78.2	1.98	50.3	30
	4VEPBF4	1/2" - 14 BSPP	steel	3.08	78.2	1.98	50.3	30
	4VEPOF4	3/4" - 16 ORB	steel	3.08	78.2	1.98	50.3	30
	4VEPOF5	7/8" - 14 ORB	steel	3.18	80.8	1.98	50.3	32
	4VEPF6	3/4" - 14 NPTF	steel	3.38	85.9	1.98	50.3	38
	4VEPBF6	3/4" - 14 BSPP	steel	3.38	85.9	1.98	50.3	38
	4VEPOF6	1-1/16" - 12 ORB	steel	3.58	90.9	1.98	50.3	38
3/4"	6VEPF6	3/4" - 14 NPTF	steel	3.37	85.6	2.19	55.6	38
	6VEPBF6	3/4" - 14 BSPP	steel	3.37	85.6	2.19	55.6	38
	6VEPOF6	1-1/16" - 12 ORB	steel	3.37	85.6	2.19	55.6	38
1"	8VEPF8	1" - 11-1/2 NPTF	steel	3.89	98.8	2.46	62.5	44
	8VEPF8-SS	1" - 11-1/2 NPTF	316 stainless	3.89	98.8	2.46	62.5	44
	8VEPBF8	1" - 11 BSPP	steel	3.89	98.8	2.46	62.5	44
	8VEPOF8	1-5/16" - 12 ORB	steel	3.89	98.8	2.46	62.5	44
1-1/4"	10VEPF10	1-1/4" - 11-1/2 NPTF	steel	4.40	111.8	2.70	68.6	55
	10VEPBF10	1-1/4" - 11 BSPP	steel	4.40	111.8	2.70	68.6	55
	10VEPOF10	1-5/8" - 12 ORB	steel	4.40	111.8	2.70	68.6	55
1-1/2"	12VEPF12	1-1/2" - 11-1/2 NPTF	steel	5.28	134.1	3.74	95.0	63
	12VEPBF12	1-1/2" - 11 BSPP	steel	5.28	134.1	3.74	95.0	63
	12VEPOF12	1-7/8" - 12 ORB	steel	5.28	134.1	3.74	95.0	63
2"	16VEPF16	2" - 11-1/2 NPTF	steel	9.42	239.3	7.39	187.7	89
	16VEPBF16	2" - 11 BSPP	steel	9.42	239.3	7.39	187.7	89
	16VEPOF16	2-1/2" - 12 ORB	steel	9.42	239.3	7.39	187.7	89

Hydraulic Couplings: VEP-Series

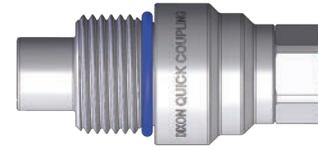
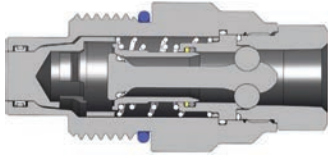

Body Size	VEP-Series Plug (Female Threads)							
	Part Detail			Length		Maximum O.D.		Hex mm
	Part #	Threads	Material	inch	mm	inch	mm	
1/4"	VEP2F2	1/4" - 18 NPTF	steel	2.67	67.8	1.35	34.3	22
	VEP2BF2	1/4" - 19 BSPP	steel	2.67	67.8	1.35	34.3	22
	VEP2OF3	9/16" - 18 ORB	steel	2.67	67.8	1.35	34.3	22
3/8"	VEP3F3	3/8" - 18 NPTF	steel	3.28	83.3	1.48	37.6	25
	VEP3BF3	3/8" - 19 BSPP	steel	3.28	83.3	1.48	37.6	25
	VEP3OF4	3/4" - 16 ORB	steel	3.50	88.9	1.48	37.6	25
	VEP3F4	1/2" - 14 NPTF	steel	3.50	88.9	1.48	37.6	28
	VEP3BF4	1/2" - 14 BSPP	steel	3.50	88.9	1.48	37.6	28
1/2"	VEP4F4	1/2" - 14 NPTF	steel	3.87	98.3	1.86	47.2	30
	VEP4BF4	1/2" - 14 BSPP	steel	3.87	98.3	1.86	47.2	30
	VEP4OF4	3/4" - 16 ORB	steel	3.87	98.3	1.86	47.2	30
	VEP4OF5	7/8" - 14 ORB	steel	3.97	100.8	1.86	47.2	32
	VEP4F6	3/4" - 14 NPTF	steel	4.07	103.4	1.86	47.2	38
	VEP4BF6	3/4" - 14 BSPP	steel	4.07	103.4	1.86	47.2	38
	VEP4OF6	1-1/16" - 12 ORB	steel	4.27	108.5	1.86	47.2	38
3/4"	VEP6F6	3/4" - 14 NPTF	steel	4.12	104.6	1.98	50.3	38
	VEP6BF6	3/4" - 14 BSPP	steel	4.12	104.6	1.98	50.3	38
	VEP6OF6	1-1/16" - 12 ORB	steel	4.12	104.6	1.98	50.3	38
1"	VEP8F8	1" - 11-1/2 NPTF	steel	4.95	125.7	2.20	55.9	44
	VEP8F8-SS	1" - 11-1/2 NPTF	316 stainless	4.95	125.7	2.20	55.9	44
	VEP8BF8	1" - 11 BSPP	steel	4.95	125.7	2.20	55.9	44
	VEP8OF8	1-5/16" - 12 ORB	steel	4.95	125.7	2.20	55.9	44
1-1/4"	VEP10F10	1-1/4" - 11-1/2 NPTF	steel	5.43	137.9	2.73	69.3	55
	VEP10BF10	1-1/4" - 11 BSPP	steel	5.43	137.9	2.73	69.3	55
	VEP10OF10	1-5/8" - 12 ORB	steel	5.43	137.9	2.73	69.3	55
1-1/2"	VEP12F12	1-1/2" - 11-1/2 NPTF	steel	6.63	168.4	3.74	95.0	63
	VEP12BF12	1-1/2" - 11 BSPP	steel	6.63	168.4	3.74	95.0	63
	VEP12OF12	1-7/8" - 12 ORB	steel	6.63	168.4	3.74	95.0	63
2"	VEP16F16	2" - 11-1/2 NPTF	steel	11.08	281.4	5.70	144.8	89
	VEP16BF16	2" - 11 BSPP	steel	11.08	281.4	5.70	144.8	89
	VEP16OF16	2-1/2" - 12 ORB	steel	11.08	281.4	5.70	144.8	89

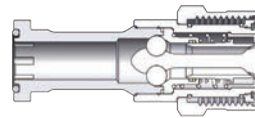

Body Size	VEP-Series Code 62 Flange Head Coupler						
	Part Detail			Length		Maximum O.D.	
	Part #	Threads	Material	inch	mm	inch	mm
3/4"	6VEPFH6	3/4"	steel	4.95	125.63	2.20	55.88
1"	8VEPFH8	1"	steel	5.34	135.64	2.47	62.74
1-1/4"	10VEPFH10	1-1/4"	steel	6.26	158.88	2.70	68.58
1-1/2"	12VEPFH12	1-1/2"	steel	8.02	203.71	3.74	95.00

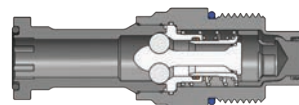

Body Size	VEP-Series Code 62 Flange Head Plug						
	Part Detail			Length		Maximum O.D.	
	Part #	Threads	Material	inch	mm	inch	mm
3/4"	VEP6FH6	3/4"	steel	5.70	144.78	1.98	50.29
1"	VEP8FH8	1"	steel	6.40	162.59	2.20	55.88
1-1/4"	VEP10FH10	1-1/4"	steel	7.30	185.42	2.73	69.34
1-1/2"	VEP12FH12	1-1/2"	steel	9.26	235.25	3.74	94.87

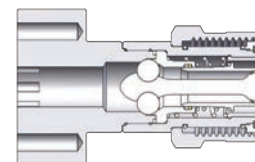

Body Size	VEP-Series Code 62 Flange Pad Coupler						
	Part Detail			Length		Maximum O.D.	
	Part #	Threads	Material	inch	mm	inch	mm
3/4"	6VEFPF6	3/4"	steel	4.45	112.93	3.02	76.71
1"	8VEFPF8	1"	steel	5.34	135.64	3.44	87.38
1-1/4"	10VEFPF10	1-1/4"	steel	5.56	141.10	4.03	102.29
1-1/2"	12VEFPF12	1-1/2"	steel	6.52	165.71	4.76	120.93

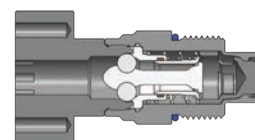

Body Size	VEP-Series Code 62 Flange Pad Plug						
	Part Detail			Length		Maximum O.D.	
	Part #	Threads	Material	inch	mm	inch	mm
3/4"	VEP6FP6	3/4"	steel	5.20	132.08	3.02	76.71
1"	VEP8FP8	1"	steel	6.40	162.59	3.44	87.38
1-1/4"	VEP10FP10	1-1/4"	steel	6.60	167.64	4.03	102.29
1-1/2"	VEP12FP12	1-1/2"	steel	7.76	197.15	4.76	120.93

Hydraulic Couplings: VEP-Series

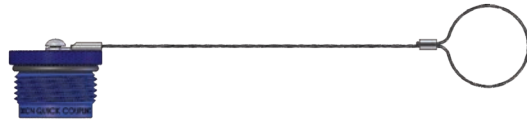

Body Size	VEP-Series Rigid Dust Plug	
	Part #	
1/4"	2VEPDP-A	
3/8"	3VEPDP-A	
1/2"	4VEPDP-A	
3/4"	6VEPDP-A	
1"	8VEPDP-A	
1-1/4"	10VEPDP-A	
1-1/2"	12VEPDP-A	
2"	16VEPDP-A	

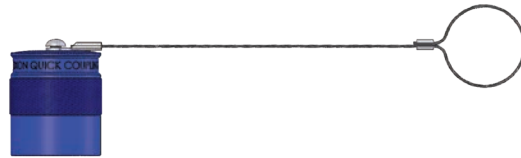

Body Size	VEP-Series Rigid Dust Cap	
	Part #	
1/4"	VEP2DC-A	
3/8"	VEP3DC-A	
1/2"	VEP4DC-A	
3/4"	VEP6DC-A	
1"	VEP8DC-A	
1-1/4"	VEP10DC-A	
1-1/2"	VEP12DC-A	
2"	VEP16DC-A	

NOTE: VEP-Series dust caps and plugs are aluminum with a steel cable

Body Size	A	B
1/4"	0.64	0.49
3/8"	0.78	0.70
1/2"	0.96	0.74
3/4"	1.06	0.76
1"	1.18	0.94
1-1/4"	1.42	0.98
1-1/2"	2.25	1.25
2"	3.43	2.44

VEP-Series Profile

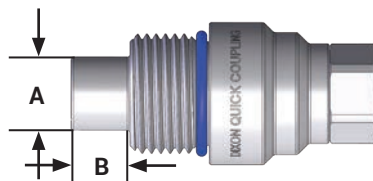

Interchange Data

- Stucchi VEP/VEP-HD Series, DNP FSI-BOP-Series

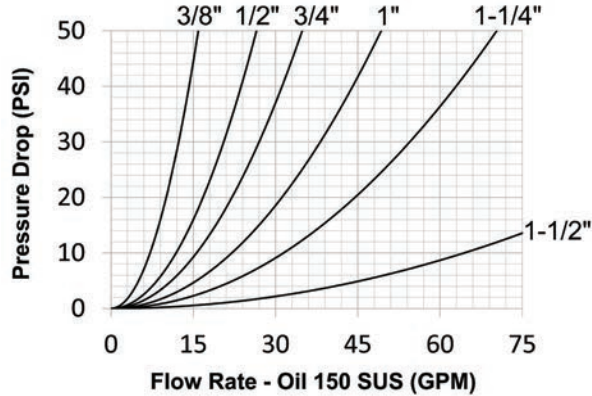

Seal Components

- Blowout preventer (BOP) coupling critical seals are severe service FKM

Materials

- Machined components are manufactured using solid steel bar stock
- Stainless steel retaining rings and springs maximize corrosion resistance and extend service life
- Steel components are plated using ROHS-compliant zinc nickel
- Red powder-coated components and external O-rings for easy BOP service identification

- BOP couplings have been fire tested and Lloyd's certified to 1300°F (700°C) in accordance with API 16D. Certificate available upon request.
- Use VEP dust caps and dust plugs found on page 144

Rated Pressure Chart

VEP-BOP-Series Interchange

Body Size	Pressure Rating				Burst Pressure						Max. Pressure Connect		Max. Pressure Disconnect		Rated Flow $\Delta P=21.75$ PSI	
	ISO Working		Max. Impulse		Connected		Coupler		Plug		PSI	Bar	PSI	Bar	GPM	L/min
	PSI	Bar	PSI	Bar	PSI	Bar	PSI	Bar	PSI	Bar						
3/8"	5,500	375	8,000	550	22,000	1,525	18,000	1,250	20,000	1,375	4,500	300	4,500	300	10.5	40
1/2"	5,500	375	8,000	550	22,000	1,525	18,000	1,250	20,000	1,375	4,500	300	4,500	300	17.5	66
3/4"	5,500	375	8,000	550	22,000	1,525	18,000	1,250	20,000	1,375	4,500	300	4,500	300	22.7	85
1"	5,500	375	7,500	525	22,000	1,525	14,500	1,000	20,000	1,375	3,625	250	3,625	250	32.5	123
1-1/4"	5,000	350	7,000	475	20,000	1,375	14,500	1,000	16,000	1,100	3,625	250	3,625	250	46.4	174
1-1/2"	5,000	300	5,800	400	18,000	1,250	12,000	8,325	14,500	1,000	3,000	200	3,000	200	95.0	360

VEP-BOP-Series Profile

Body Size	A	B
3/8"	0.78	0.70
1/2"	0.96	0.74
3/4"	1.06	0.76
1"	1.18	0.94
1-1/4"	1.42	0.98
1-1/2"	2.25	1.25

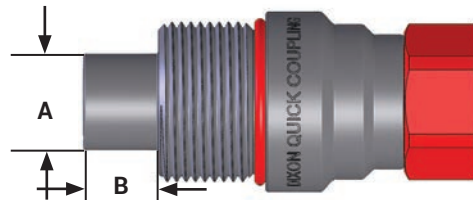

Hydraulic Couplings: VEP-BOP-Series

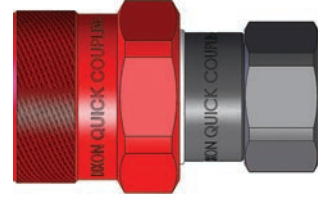
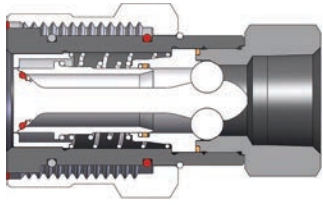

Body Size	VEP-BOP-Series Blowout Preventer Safety Coupler (Female Threads)							
	Part Detail			Length		Maximum O.D.		Hex mm
	Part #	Threads	Material	inch	mm	inch	mm	
3/8"	3VEPF3-BOP	3/8" - 18 NPTF	steel	2.55	64.8	1.62	41.1	25
	3VEPF4-BOP	1/2" - 14 NPTF	steel	2.77	70.4	1.62	41.1	28
1/2"	4VEPF4-BOP	1/2" - 14 NPTF	steel	3.08	78.2	1.98	50.3	30
3/4"	6VEPF6-BOP	3/4" - 14 NPTF	steel	3.37	85.6	2.19	55.6	38
1"	8VEPF8-BOP	1" - 11-1/2 NPTF	steel	3.89	98.8	2.46	62.5	44
1-1/4"	10VEPF10-BOP	1-1/4" - 11-1/2 NPTF	steel	4.40	111.8	2.70	68.6	55
1-1/2"	12VEPF12-BOP	1-1/2" - 11-1/2 NPTF	steel	5.28	134.1	3.74	95.0	63

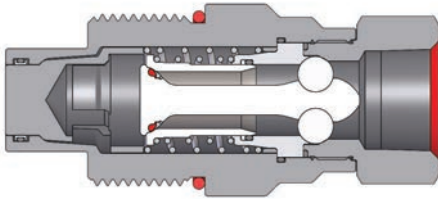

Body Size	VEP-BOP-Series Blowout Preventer Safety Plug (Female Threads)							
	Part Detail			Length		Maximum O.D.		Hex mm
	Part #	Threads	Material	inch	mm	inch	mm	
3/8"	VEP3F3-BOP	3/8" - 18 NPTF	steel	3.28	83.3	1.48	37.6	25
	VEP3F4-BOP	1/2" - 14 NPTF	steel	3.50	88.9	1.48	37.6	28
1/2"	VEP4F4-BOP	1/2" - 14 NPTF	steel	3.87	98.3	1.86	47.2	30
3/4"	VEP6F6-BOP	3/4" - 14 NPTF	steel	4.12	104.6	1.98	50.3	38
1"	VEP8F8-BOP	1" - 11-1/2 NPTF	steel	4.95	125.7	2.20	55.9	44
1-1/4"	VEP10F10-BOP	1-1/4" - 11-1/2 NPTF	steel	5.43	137.9	2.73	69.3	55
1-1/2"	VEP12F12-BOP	1-1/2" - 11-1/2 NPTF	steel	6.63	164.4	3.74	95.0	63

Interchange Data

- Eaton/Aeroquip 5100-Series, Parker 6100-Series
- Snap-Tite 78-Series, Faster Series-FB, Safeway S51-Series

Materials

- Machined components are manufactured using solid steel and brass bar stock
- Stainless steel retaining rings and springs maximize corrosion resistance and extend service life
- Steel componentry is plated using ROHS-compliant trivalent chrome
- Rugged steel wing nut for threaded connect and disconnect operation
- For steel models, coupler valve sleeve and plug valve are constructed of brass

Seal Components

- Nitrile seals are standard, providing a temperature range of **-40°F to 250°F (-40°C to 121°C)**
- Couplings have a TPC-ET back-up ring on the main coupler valve sleeve to extend service life
- Main coupler valve has a bonded face-seal to improve seal integrity during pressurized connection/disconnection
- Plug valve seal is crimped to improve seal integrity and prolong service life; 1-1/2" has bonded plug valve
- External O-ring on plug indicates full connection and acts as a contamination shield in connected mode
- Redundant O-ring on the coupler body will engage plug for secondary sealing support

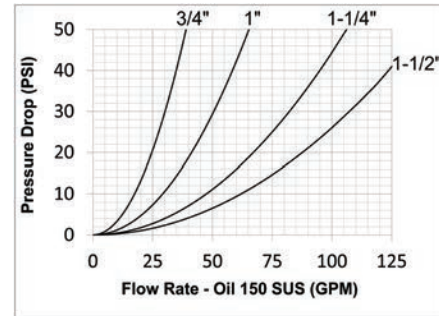

Rated Pressure Chart

Body Size	W-Series Wingstyle Interchange (Connected)			
	Coupler/Plug			
	Maximum Working		Burst	
	PSI	Bar	PSI	Bar
1/4"	3,000	207	14,000	965
3/8"	3,000	207	13,000	897
3/4"	3,000	207	13,000	897
1"	4,000	276	16,000	1,103
1-1/4"	3,000	207	12,000	828
1-1/2"	2,500	172	10,000	690

Technical Specifications

Body Size	Interchange Standards				Functional Parameters				
	U.S. Military	U.S. Government	International Standards	ANSI/NFPA Standards	Locking Mechanism	Air Inclusion	Fluid Loss	Vacuum inch HG	Flow ΔP = 32 PSI
1/4"					threaded	0.03cc	0.01cc	27.4	6 GPM
3/8"					threaded	0.05cc	0.06cc	27.4	15 GPM
3/4"	-	-	-	-	threaded	0.34cc	0.26cc	27.4	31 GPM
1"	-	-	-	-	threaded	0.50cc	0.35cc	27.4	52 GPM
1-1/4"	-	-	-	-	threaded	0.68cc	0.70cc	27.4	85 GPM
1-1/2"	-	-	-	-	threaded	0.60cc	0.94cc	27.4	110 GPM

! Although the wingstyle couplings are able to connect and disconnect while under pressure, it is recommended that hydraulic power supply be de-energized during connection to ensure operator safety. If it is not possible to de-energize the circuit, operators must be aware of their surroundings to ensure that an attachment or tool does not put them at risk, once hydraulic power is applied during the connection process.

NOTE: W-Series couplings are not recommended for continuous hydraulic impulse applications at rated pressures.

Wingstyle Socket Features

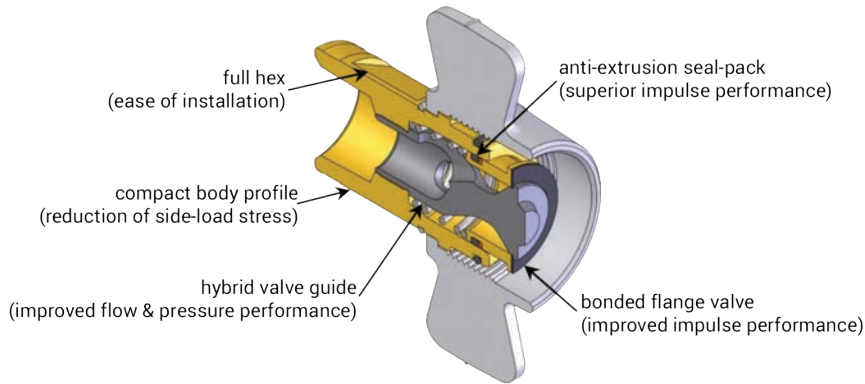

Wingstyle Plug Features

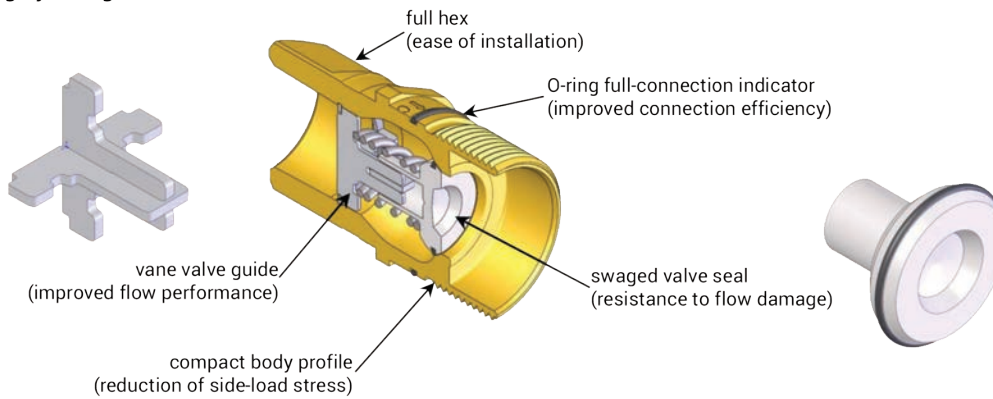

Hybrid valve design increases flow and pressure performance.



industry norm tubular valve guide

versus



hybrid valve guide

Body Size	A	B
1/4"	0.93	0.94
3/8"	1.12	1.06
3/4"	1.49	0.95
1"	1.85	1.49
1-1/4"	2.12	1.62
1-1/2"	2.47	1.91

W-Series Profiles

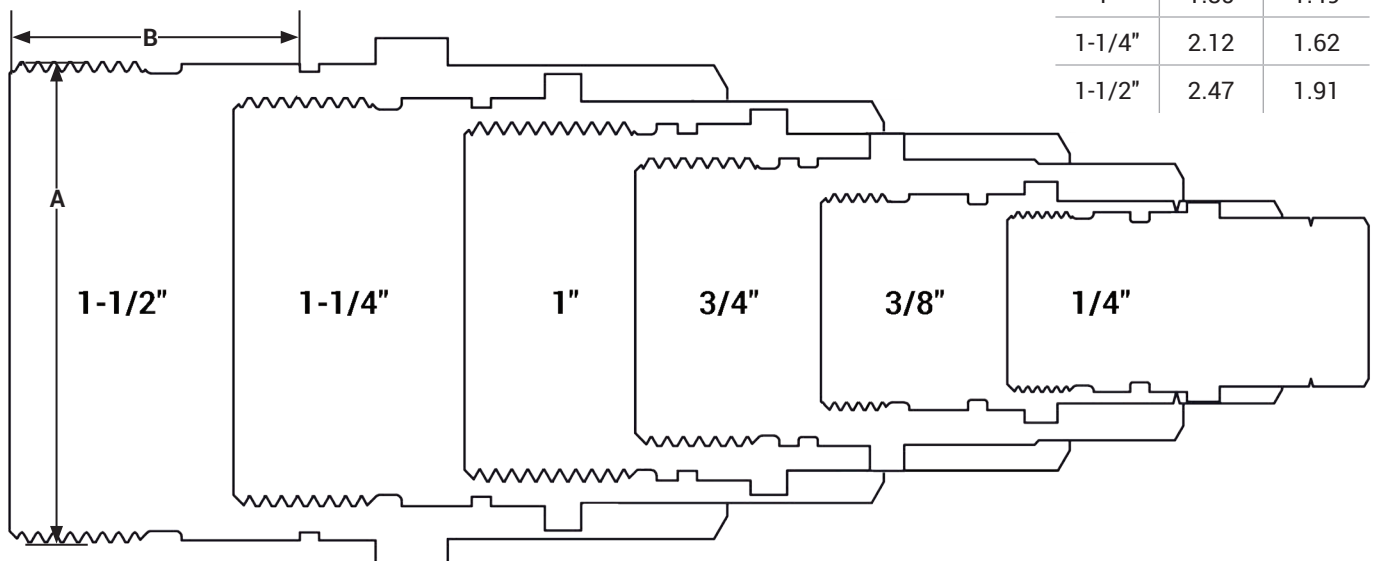

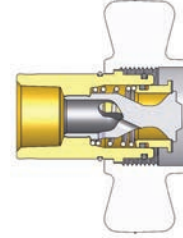

Body Size	W-Series Wingstyle Interchange Coupler (Female Threads)							
	Part Detail			Length		Maximum O.D.		Flats inch
	Part #	Threads	Material	inch	mm	inch	mm	
1/4"	2WF1-B	1/8" - 27 NPTF	brass	2.00	50.8	3.02	76.7	5/8"
3/8"	3WF2-B	1/4" - 18 NPTF	brass	2.33	59.1	3.46	87.8	13/16"
	3WF3-B	3/8" - 18 NPTF	brass	2.33	59.1	3.46	87.8	13/16"
3/4"	6WF4-B	1/2" - 14 NPTF	brass	2.73	69.3	4.09	103.9	1-5/32"
	6WBF4-B	1/2" - 14 BSPP	brass	2.73	69.3	4.09	103.9	1-5/32"
	6WF6-B	3/4" - 14 NPTF	brass	2.73	69.3	4.09	103.9	1-5/32"
	6WBF6-B	3/4" - 14 BSPP	brass	2.73	69.3	4.09	103.9	1-5/32"
1"	8WF8-B	1" - 11-1/2 NPTF	brass	3.33	84.6	4.49	114.0	1-15/32"
	8WF8	1" - 11-1/2 NPTF	steel	3.33	84.6	4.49	114.0	1-15/32"
	8WBF8-B	1" - 11 BSPP	brass	3.33	84.6	4.49	114.0	1-15/32"
1-1/4"	10WF10-B	1-1/4" - 11-1/2 NPTF	brass	3.64	92.5	5.27	133.9	1-25/32"
	10WBF10-B	1-1/4" - 11 BSPP	brass	3.64	92.5	5.27	133.9	1-25/32"
1-1/2"	12WF12-B	1-1/2" - 11-1/2 NPTF	brass	3.67	93.2	5.35	135.9	2-7/64"
	12WBF12-B	1-1/2" - 11 BSPP	brass	4.08	103.6	5.35	135.9	2-7/64"

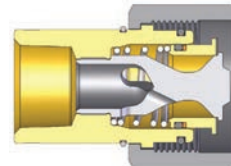
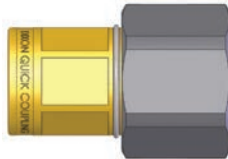

Body Size	W-Series Wingstyle Interchange Hex-Nut Coupler (Female Threads)							
	Part Detail			Length		Maximum O.D.		Hex inch
	Part #	Threads	Material	inch	mm	inch	mm	
1/4"	2WF1-B-HN	1/8" - 27 NPTF	brass	2.00	50.8	3.00	76.2	0.63"
3/8"	3WF2-B-HN	1/4" - 18 NPTF	brass	2.33	59.2	3.45	87.6	0.81"
	3WF3-B-HN	3/8" - 18 NPTF	brass	2.33	59.2	3.45	87.6	0.81"
3/4"	6WF4-B-HN	1/2" - 14 NPTF	brass	2.73	69.3	1.92	48.8	1-5/32"
	6WBF4-B-HN	1/2" - 14 BSPP	brass	2.73	69.3	1.92	48.8	1-5/32"
	6WF6-B-HN	3/4" - 14 NPTF	brass	2.73	69.3	1.92	48.8	1-5/32"
	6WBF6-B-HN	3/4" - 14 BSPP	brass	2.73	69.3	1.92	48.8	1-5/32"
1"	8WF8-B-HN	1" - 11-1/2 NPTF	brass	3.33	84.6	2.33	59.2	1-15/32"
	8WF8-HN	1" - 11-1/2 NPTF	steel	3.33	84.6	2.33	59.2	1-15/32"
	8WBF8-B-HN	1" - 11 BSPP	brass	3.33	84.6	2.33	59.2	1-15/32"
1-1/4"	10WF10-B-HN	1-1/4" - 11-1/2 NPTF	brass	3.64	92.5	2.75	69.9	1-25/32"
	10WBF10-B-HN	1-1/4" - 11 BSPP	brass	3.64	92.5	2.75	69.9	1-25/32"
1-1/2"	12WF12-B-HN	1-1/2" - 11-1/2 NPTF	brass	3.67	93.2	3.01	76.5	2-7/64"
	12WBF12-B-HN	1-1/2" - 11 BSPP	brass	3.67	93.2	3.01	76.5	2-7/64"

Hydraulic Couplings: W-Series

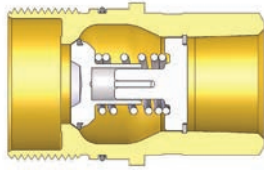

Body Size	W-Series Wingstyle Interchange Plug (Female Threads)							
	Part Detail			Length		Maximum O.D.		Hex inch
	Part #	Threads	Material	inch	mm	inch	mm	
1/4"	W2F1-B	1/8"-27 NPTF	brass	1.88	47.8	1.04	26.3	15/16"
3/8"	W3F2-B	1/4"-18 NPTF	brass	2.30	58.4	1.25	31.8	1-1/4"
	W3F3-B	3/8"-18 NPTF	brass	2.40	61.0	1.25	31.8	1-1/4"
3/4"	W6F4-B	1/2" - 14 NPTF	brass	2.85	72.4	1.75	44.5	1-5/16"
	W6BF4-B	1/2" - 14 BSPP	brass	2.85	72.4	1.75	44.5	1-5/16"
	W6F6-B	3/4" - 14 NPTF	brass	2.85	72.4	1.75	44.5	1-5/16"
	W6BF6-B	3/4" - 14 BSPP	brass	2.85	72.4	1.75	44.5	1-5/16"
1"	W8F8-B	1" - 11-1/2 NPTF	brass	3.15	80.0	2.00	50.8	1-9/16"
	W8F8	1" - 11-1/2 NPTF	steel	3.15	80.0	2.00	50.8	1-9/16"
	W8BF8-B	1" - 11 BSPP	brass	3.15	80.0	2.00	50.8	1-9/16"
1-1/4"	W10F10-B	1-1/4" - 11-1/2 NPTF	brass	3.39	86.1	2.37	60.2	1-15/16"
	W10BF10-B	1-1/4" - 11 BSPP	brass	3.39	86.1	2.37	60.2	1-15/16"
1-1/2"	W12F12-B	1-1/2" - 11-1/2 NPTF	brass	3.74	95.0	2.73	69.3	2-1/4"
	W12BF12-B	1-1/2" - 11 BSPP	brass	3.74	95.0	2.73	69.3	2-1/4"

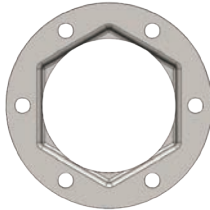

Plug not included with flange

Body Size	W-Series Wingstyle Interchange Plug Mounting Flange		
	Part Detail		
	Part #	Bolt Hole Size	Material
3/4"	W6-BMF	0.201"	steel
1"	W8-BMF	0.201"	steel
1-1/4"	W10-BMF	0.201"	steel
1-1/2"	W12-BMF	0.201"	steel



Body Size	W-Series Wingstyle Interchange Coupler Rigid Dust Plug		
	Part Detail		
	Part #	Lanyard	Body
1/4"	2WDP	steel cable	steel
3/8"	3WDP	steel cable	steel
3/4"	6WDP	steel cable	steel
1"	8WDP	steel cable	steel
1-1/4"	10WDP	steel cable	steel
1-1/2"	12WDP	steel cable	steel



Body Size	W-Series Wingstyle Interchange Plug Rigid Dust Cap		
	Part Detail		
	Part #	Lanyard	Body
1/4"	W2DC	steel cable	steel
3/8"	W3DC	steel cable	steel
3/4"	W6DC	steel cable	steel
1"	W8DC	steel cable	steel
1-1/4"	W10DC	steel cable	steel
1-1/2"	W12DC	steel cable	steel

Body Size	W-Series Wingstyle Interchange Coupler Repair Kits			
	Part Detail			Repair Kit Contents (for one coupler)
	Part #	Coupler Style	Seal Material	
3/4"	6W-RKIT-V2	all	Nitrile	bonded valve, O-rings, and Hytrel® backup
1"	8W-RKIT-V2	all	Nitrile	bonded valve, O-rings, and Hytrel® backup
1-1/4"	10W-RKIT-V2	all	Nitrile	bonded valve, O-rings, and Hytrel® backup
1-1/2"	12W-RKIT-V2	all	Nitrile	bonded valve, O-rings, and Hytrel® backup

Body Size	W-Series Wingstyle Interchange Plug Repair Kits			
	Part Detail			Repair Kit Contents (for one coupler)
	Part #	Coupler Style	Seal Material	
3/4"	W6-RKIT-V2	all	Nitrile	valve assembly and O-ring
1"	W8-RKIT-V2	all	Nitrile	valve assembly and O-ring
1-1/4"	W10-RKIT-V2	all	Nitrile	valve assembly and O-ring
1-1/2"	W12-RKIT-V2	all	Nitrile	valve assembly and O-ring

Hydraulic Couplings: WS-Series

Interchange Data

- Parker/ Snap-Tite 75-Series, Hydraulics Inc. Series-5TV, DNP VFF-HD, Stucchi VOF, Faster OGV, Eaton FD85, Holmbury LC

Materials

- Machined components are manufactured using solid steel or 316 stainless steel bar stock
- Stainless steel retaining rings and springs maximize corrosion resistance and extend service life
- Steel componentry is plated using ROHS compliant zinc nickel for corrosion resistance
- Rugged high-strength steel sand-cast wing nut for threaded connect and disconnect operation
- 316 stainless steel plug connection-threads are coated to prevent galling during connection/disconnection

Seal Components

- Nitrile seals are standard, providing a temperature range of -40°F to 250°F (-40°C to 121°C)
- PTFE anti-extrusion ring protects main coupling O-ring from dynamic impulse pressure damage

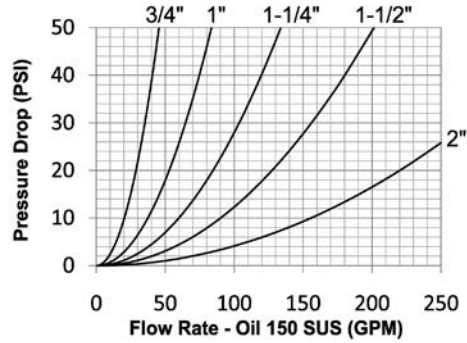

Rated Pressure Chart

Body Size	WS-Series Heavy-Duty Wingstyle (Connected)							
	Steel Coupler/Plug				316 Stainless Steel Coupler/Plug			
	Maximum Working		Burst		Maximum Working		Burst	
	PSI	Bar	PSI	Bar	PSI	Bar	PSI	Bar
3/4"	5,000	345	32,800	2,200	3,000	200	20,000	1,400
1"	5,000	345	25,100	1,700	3,000	200	20,000	1,400
1-1/4"	5,000	345	25,100	1,700	3,000	200	15,000	1,000
1-1/2"	5,000	345	20,000	1,400	3,000	200	15,000	1,000
2"	5,000	345	15,000	1,000	3,000	200	15,000	1,000

Technical Specifications

Body Size	Interchange Standards				Functional Parameters				
	U.S. Military	U.S. Government	International Standards	ANSI/NFPA Standards	Locking Mechanism	Air Inclusion	Fluid Loss	Vacuum inch HG	Flow ΔP = 30 PSI
3/4"	-	-	-	-	threaded	10cc	10cc	27.4	35 GPM
1"	-	-	-	-	threaded	23cc	15cc	27.4	65 GPM
1-1/4"	-	-	-	-	threaded	50cc	30cc	27.4	105 GPM
1-1/2"	-	-	-	-	threaded	100cc	60cc	27.4	160 GPM
2"					threaded	200cc	135cc	27.4	270 GPM

Available Options

Body Size	Standard Seal Options					Standard Coupling Options		
	FKM	EPDM	Mil-Nitrile	Fuel Nitrile	Silicone	Wrench Flats	View Port	Oxy-Clean
	Pre	Pre	Pre	Pre	Pre	Suf	Suf	Suf
3/4"	F-	P-	M-	JF-	S-	-WF	-VP	-C1
1"	F-	P-	M-	JF-	S-	-WF	-VP	-C1
1-1/4"	F-	P-	M-	JF-	S-	-WF	-VP	-C1
1-1/2"	F-	P-	M-	JF-	S-	-WF	-VP	-C1
2"	F-	P-	M-	JF-	S-	-WF	-VP	-C1

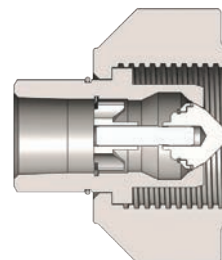

Body Size	WS-Series Heavy-Duty Wingstyle Coupler (Female Threads)							
	Part Detail			Length		Maximum O.D.		Hex inch
	Part #	Threads	Material	inch	mm	inch	mm	
3/4"	6WSF4	1/2" - 14 NPTF	steel	2.76	70.1	3.31	82.0	-
	6WSF6	3/4" - 14 NPTF	steel	2.76	70.1	3.31	82.0	-
	6WSF6-SS	3/4" - 14 NPTF	316 stainless	2.76	70.1	3.31	82.0	-
	6WSBF6	3/4" - 14 BSPP	steel	2.76	70.1	3.31	82.0	-
	6WSBF6-SS	3/4" - 14 BSPP	316 stainless	2.76	70.1	3.31	82.0	-
	6WSOF6	1-1/16" - 12 ORB	steel	2.76	70.1	3.31	82.0	-
1"	8WSF8	1" - 11-1/2 NPTF	steel	3.45	87.6	4.10	101.6	-
	8WSF8-SS	1" - 11-1/2 NPTF	316 stainless	3.45	87.6	4.10	101.6	-
	8WSBF8	1" - 11 BSPP	steel	3.45	87.6	4.10	101.6	-
	8WSBF8-SS	1" - 11 BSPP	316 stainless	3.45	87.6	4.10	101.6	-
	8WSOF8	1-5/16" - 12 ORB	steel	3.45	87.6	4.10	101.6	-
1-1/4"	10WSF10	1-1/4" - 11-1/2 NPTF	steel	4.40	111.8	4.78	118.1	-
	10WSF10-SS	1-1/4" - 11-1/2 NPTF	316 stainless	4.40	111.8	4.78	118.1	-
	10WSBF10	1-1/4" - 11 BSPP	steel	4.40	111.8	4.78	118.1	-
	10WSBF10-SS	1-1/4" - 11 BSPP	316 stainless	4.40	111.8	4.78	118.1	-
	10WSOF10	1-5/8" - 12 ORB	steel	4.40	111.8	4.78	118.1	-
1-1/2"	12WSF12	1-1/2" - 11-1/2 NPTF	steel	5.13	130.3	5.68	137.9	-
	12WSF12-SS	1-1/2" - 11-1/2 NPTF	316 stainless	5.13	130.3	5.68	137.9	-
	12WSBF12	1-1/2" - 11 BSPP	steel	5.13	130.3	5.68	137.9	-
	12WSBF12-SS	1-1/2" - 11 BSPP	316 stainless	5.13	130.3	5.68	137.9	-
	12WSOF12	1-7/8" - 12 ORB	steel	5.13	130.3	5.68	137.9	-
2"	16WSF16	2" - 11-1/2 NPTF	steel	6.09	154.7	6.90	170.9	-
	16WSF16-SS	2" - 11-1/2 NPTF	316 stainless	6.09	154.7	6.90	170.9	-
	16WSBF16	2" - 11 BSPP	steel	6.09	154.7	6.90	170.9	-
	16WSBF16-SS	2" - 11 BSPP	316 stainless	6.09	154.7	6.90	170.9	-
	16WSOF16	2-1/2" - 12 ORB	steel	6.09	154.7	6.90	170.9	-

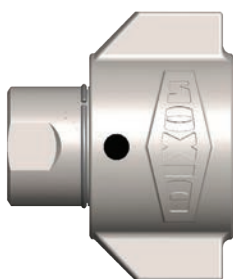

WS coupler with view port



WS coupler with wrench flats

NOTE: Wrench flats may result in reduced pressure performance.

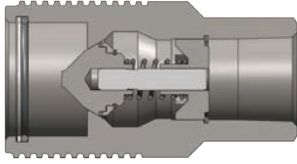

Body Size	WS-Series Heavy-Duty Wingstyle Plug (Female Threads)							
	Part Detail			Length		Maximum O.D.		Hex inch
	Part #	Threads	Material	inch	mm	inch	mm	
3/4"	WS6F4	1/2" - 14 NPTF	steel	3.27	83.1	1.74	44.2	-
	WS6F6	3/4" - 14 NPTF	steel	3.27	83.1	1.74	44.2	-
	WS6F6-SS	3/4" - 14 NPTF	316 stainless	3.27	83.1	1.74	44.2	-
	WS6BF6	3/4" - 14 BSPP	steel	3.27	83.1	1.74	44.2	-
	WS6BF6-SS	3/4" - 14 BSPP	316 stainless	3.27	83.1	1.74	44.2	-
	WS6OF6	1-1/16" - 12 ORB	steel	3.27	83.1	1.74	44.2	-
1"	WS8F8	1" - 11-1/2 NPTF	steel	4.18	106.2	2.25	57.2	-
	WS8F8-SS	1" - 11-1/2 NPTF	316 stainless	4.18	106.2	2.25	57.2	-
	WS8BF8	1" - 11 BSPP	steel	4.18	106.2	2.25	57.2	-
	WS8BF8-SS	1" - 11 BSPP	316 stainless	4.18	106.2	2.25	57.2	-
	WS8OF8	1-5/16" - 12 ORB	steel	4.18	106.2	2.25	57.2	-
1-1/4"	WS10F10	1-1/4" - 11-1/2 NPTF	steel	5.38	136.7	2.63	66.8	-
	WS10F10-SS	1-1/4" - 11-1/2 NPTF	316 stainless	5.38	136.7	2.63	66.8	-
	WS10BF10	1-1/4" - 11 BSPP	steel	5.38	136.7	2.63	66.8	-
	WS10BF10-SS	1-1/4" - 11 BSPP	316 stainless	5.38	136.7	2.63	66.8	-
	WS10OF10	1-5/8" - 12 ORB	steel	5.38	136.7	2.63	66.8	-
1-1/2"	WS12F12	1-1/2" - 11-1/2 NPTF	steel	5.98	151.9	3.25	82.6	-
	WS12F12-SS	1-1/2" - 11-1/2 NPTF	316 stainless	5.98	151.9	3.25	82.6	-
	WS12BF12	1-1/2" - 11 BSPP	steel	5.98	151.9	3.25	82.6	-
	WS12BF12-SS	1-1/2" - 11 BSPP	316 stainless	5.98	151.9	3.25	82.6	-
	WS12OF12	1-7/8" - 12 ORB	steel	5.98	151.9	3.25	82.6	-
2"	WS16F16	2" - 11-1/2 NPTF	steel	7.05	179.1	4.00	101.6	-
	WS16F16-SS	2" - 11-1/2 NPTF	316 stainless	7.05	179.1	4.00	101.6	-
	WS16BF16	2" - 11 BSPP	steel	7.05	179.1	4.00	101.6	-
	WS16BF16-SS	2" - 11 BSPP	316 stainless	7.05	179.1	4.00	101.6	-
	WS16OF16	2-1/2" - 12 ORB	steel	7.05	179.1	4.00	101.6	-

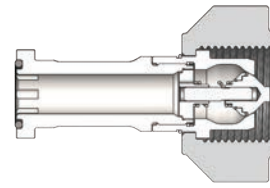
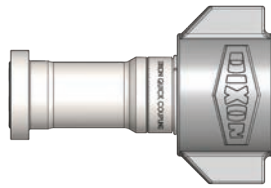

Body Size	WS-Series Heavy-Duty Wingstyle Code 62 Flange Head Coupler						
	Part Detail			Length		Maximum O.D.	
	Part #	Port Size	Material	inch	mm	inch	mm
3/4"	6WSFH6	3/4" code 62 flange head	steel	4.79	121.67	3.31	84.07
1"	8WSFH8	1" code 62 flange head	steel	6.98	177.29	4.10	104.14
1-1/4"	10WSFH10	1-1/4" code 62 flange head	steel	8.27	210.06	4.78	121.41
1-1/2"	12WSFH12	1-1/2" code 62 flange head	steel	9.30	236.14	5.68	144.27
2"	16WSFH16	2" code 62 flange head	steel	10.82	274.93	6.90	175.26

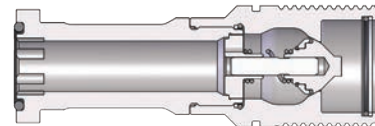

Body Size	WS-Series Heavy-Duty Wingstyle Code 62 Flange Head Plug						
	Part Detail			Length		Maximum O.D.	
	Part #	Port Size	Material	inch	mm	inch	mm
3/4"	WS6FH6	3/4" code 62 flange head	steel	5.23	132.84	1.74	44.20
1"	WS8FH8	1" code 62 flange head	steel	7.84	199.14	2.25	57.15
1-1/4"	WS10FH10	1-1/4" code 62 flange head	steel	9.39	238.61	2.63	66.68
1-1/2"	WS12FH12	1-1/2" code 62 flange head	steel	10.15	257.76	3.25	82.55
2"	WS16FH16	2" code 62 flange head	steel	11.78	299.31	4.00	101.60

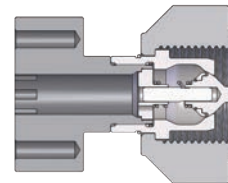
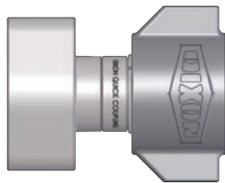

Body Size	WS-Series Heavy-Duty Wingstyle Code 62 Flange Pad Coupler						
	Part Detail			Length		Maximum O.D.	
	Part #	Port Size	Material	inch	mm	inch	mm
3/4"	6WSFP6	3/4" code 62 flange pad	steel	4.04	102.62	3.31	84.07
1"	8WSFP8	1" code 62 flange pad	steel	5.48	139.19	4.10	104.14
1-1/4"	10WSFP10	1-1/4" code 62 flange pad	steel	6.79	172.47	4.78	121.41
1-1/2"	12WSFP12	1-1/2" code 62 flange pad	steel	8.40	213.31	5.68	144.27
2"	16WSFP16	2" code 62 flange pad	steel	9.40	238.73	6.90	175.26

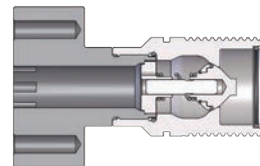
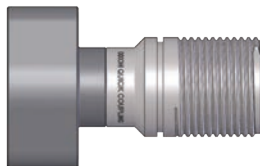

Body Size	WS-Series Heavy-Duty Wingstyle Code 62 Flange Pad Plug						
	Part Detail			Length		Maximum O.D.	
	Part #	Port Size	Material	inch	mm	inch	mm
3/4"	WS6FP6	3/4" code 62 flange pad	steel	4.48	113.79	3.02	76.71
1"	WS8FP8	1" code 62 flange pad	steel	6.34	161.04	3.44	87.40
1-1/4"	WS10FP10	1-1/4" code 62 flange pad	steel	7.91	201.02	4.03	102.41
1-1/2"	WS12FP12	1-1/2" code 62 flange pad	steel	9.25	234.90	4.76	120.90
2"	WS16FP16	2" code 62 flange pad	steel	10.36	263.12	5.67	144.12



Body Size	WS-Series Coupler Rigid Dust Plug		
	Part Detail		
	Part #	Lanyard	Body
3/4"	6WSDP-A	steel cable	aluminum
1"	8WSDP-A	steel cable	aluminum
1-1/4"	10WSDP-A	steel cable	aluminum
1-1/2"	12WSDP-A	steel cable	aluminum
2"	16WSDP-A	steel cable	aluminum

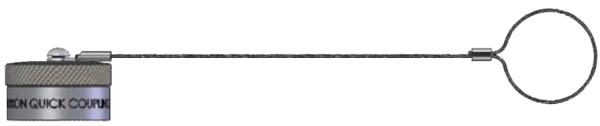

Body Size	WS-Series Plug Rigid Dust Cap		
	Part Detail		
	Part #	Lanyard	Body
3/4"	WS6DC-A	steel cable	aluminum
1"	WS8DC-A	steel cable	aluminum
1-1/4"	WS10DC-A	steel cable	aluminum
1-1/2"	WS12DC-A	steel cable	aluminum
2"	WS16DC-A	steel cable	aluminum

Body Size	WS-Series Heavy-Duty Wingstyle Interchange Coupler Seal Kits			
	Part Detail			Seal Kit Contents
	Part #	Coupler Style	Seal Material	
3/4"	6WS-SKIT	all	Nitrile	body / valve seals and retaining rings
1"	8WS-SKIT	all	Nitrile	body / valve seals and retaining rings
1-1/4"	10WS-SKIT	all	Nitrile	body / valve seals and retaining rings
1-1/2"	12WS-SKIT	all	Nitrile	body / valve seals and retaining rings
2"	16WS-SKIT	all	Nitrile	body / valve seals and retaining rings

Body Size	WS-Series BOP Wingstyle Interchange Coupler Seal Kits			
	Part Detail			Seal Kit Contents
	Part #	Coupler Style	Seal Material	
3/4"	6BOP-SKIT	all	FR FKM	body / valve seals and retaining rings
1"	8BOP-SKIT	all	FR FKM	body / valve seals and retaining rings
1-1/4"	10BOP-SKIT	all	FR FKM	body / valve seals and retaining rings
1-1/2"	12BOP-SKIT	all	FR FKM	body / valve seals and retaining rings
2"	16BOP-SKIT	all	FR FKM	body / valve seals and retaining rings

Body Size	WS-Series Heavy-Duty Wingstyle Interchange Coupler Repair Kits			
	Part Detail			Repair Kit Contents (for one coupler or plug)
	Part #	Coupler Style	Seal Material	
3/4"	6WS-RKIT	all	Nitrile	valve assembly, O-ring, and PTFE B.U.
1"	8WS-RKIT	all	Nitrile	valve assembly, O-ring, and PTFE B.U.
1-1/4"	10WS-RKIT	all	Nitrile	valve assembly, O-ring, and PTFE B.U.
1-1/2"	12WS-RKIT	all	Nitrile	valve assembly, O-ring, and PTFE B.U.
2"	16WS-RKIT	all	Nitrile	valve assembly, O-ring, and PTFE B.U.

Hydraulic Couplings: WS-BOP-Series

Interchange Data

- Parker/Snap-Tite 75-Series, DNP VFF-HD BOP-Series

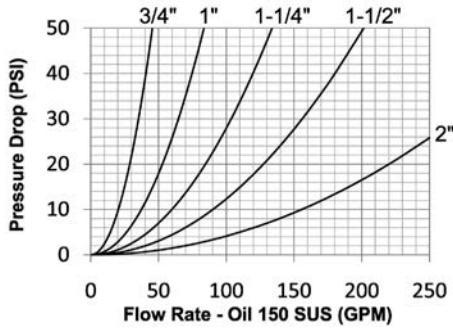

Seal Components

- Blowout preventer (BOP) couplings contain severe service FKM seals
- PTFE anti-extrusion ring protects main coupling valve seal from dynamic impulse pressure damage

Materials

- Machined components are manufactured using solid steel or 316 stainless steel bar stock
- Stainless steel retaining rings and springs maximize corrosion resistance and extend service life
- Steel componentry is plated using ROHS-compliant zinc nickel
- Rugged high-strength steel wing nut for threaded connect and disconnect operation
- 316 stainless steel plug connection-threads are coated to prevent galling during connection/disconnection
- Red powder-coated coupler wing-nut and external plug O-ring for easy BOP service identification

- BOP couplings have been fire tested and Lloyd's certified to 1300°F (700°C) in accordance with API 16D. Certificate available upon request.
- Use WS dust caps and dust plugs found on page 156

Rated Pressure Chart

Body Size	WS-BOP-Series Blowout Preventer Heavy-Duty Wingstyle							
	Steel Coupler/Plug				316 SS Coupler/Plug			
	Maximum Working		Burst		Maximum Working		Burst	
	PSI	Bar	PSI	Bar	PSI	Bar	PSI	Bar
3/4"	5,000	345	32,800	2,200	5,000	345	20,000	1,400
1"	5,000	345	25,100	1,700	5,000	345	20,000	1,400
1-1/4"	5,000	345	25,100	1,700	5,000	345	15,000	1,000
1-1/2"	5,000	345	20,000	1,400	5,000	345	15,000	1,000
2"	5,000	345	15,000	1,000	5,000	345	15,000	1,000

Technical Specifications

Body Size	Functional Parameters					Lloyd's Test Pressure	
	Locking Mechanism	Air Inclusion	Fluid Loss	Vacuum inch HG	Flow ΔP = 30 PSI	PSI	
3/4"	threaded	10 cc	10 cc	27.4	35 GPM	5,000	
1"	threaded	23 cc	15 cc	27.4	65 GPM	5,000	
1-1/4"	threaded	50 cc	30 cc	27.4	105 GPM	5,000	
1-1/2"	threaded	100 cc	60 cc	27.4	160 GPM	5,000	
2"	threaded	200 cc	135 cc	27.4	270 GPM	5,000	

Body Size	A	B
3/4"	1.74	1.53
1"	2.25	1.90
1-1/4"	2.63	2.28
1-1/2"	3.25	2.80
2"	4.00	3.64

WS-BOP-Series Profile

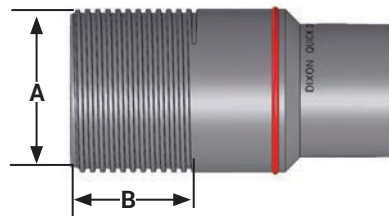

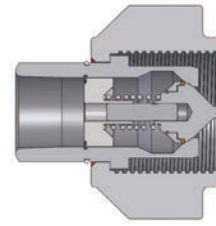

Body Size	WS-BOP-Series Blowout Preventer Safety Coupler (Female Threads)							
	Part Detail			Length		Maximum O.D.		Hex inch
	Part #	Threads	Material	inch	mm	inch	mm	
3/4"	6WSF4-BOP	1/2" - 14 NPTF	steel	2.76	70.1	3.31	82.0	-
	6WSF6-BOP	3/4" - 14 NPTF	steel	2.76	70.1	3.31	82.0	-
	6WSF6-SS-BOP	3/4" - 14 NPTF	316 stainless	2.76	70.1	3.31	82.0	-
1"	8WSF8-BOP	1" - 11-1/2 NPTF	steel	3.45	87.6	4.10	101.6	-
	8WSF8-SS-BOP	1" - 11-1/2 NPTF	316 stainless	3.45	87.6	4.10	101.6	-
1-1/4"	10WSF10-BOP	1-1/4" - 11-1/2 NPTF	steel	4.40	111.8	4.78	118.1	-
	10WSF10-SS-BOP	1-1/4" - 11-1/2 NPTF	316 stainless	4.40	111.8	4.78	118.1	-
1-1/2"	12WSF12-BOP	1-1/2" - 11-1/2 NPTF	steel	5.13	130.3	5.68	137.9	-
	12WSF12-SS-BOP	1-1/2" - 11-1/2 NPTF	316 stainless	5.13	130.3	5.68	137.9	-
2"	16WSF16-BOP	2" - 11-1/2 NPTF	steel	6.09	154.7	6.90	170.9	-
	16WSF16-SS-BOP	2" - 11-1/2 NPTF	316 stainless	6.09	154.7	6.90	170.9	-

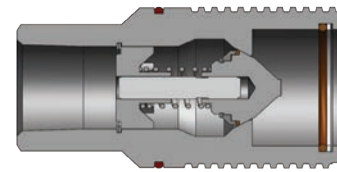

Body Size	WS-BOP-Series Blowout Preventer Safety Plug (Female Threads)							
	Part Detail			Length		Maximum O.D.		Hex inch
	Part #	Threads	Material	inch	mm	inch	mm	
3/4"	WS6F4-BOP	1/2" - 14 NPTF	steel	3.27	83.1	1.74	44.2	-
	WS6F6-BOP	3/4" - 14 NPTF	steel	3.27	83.1	1.74	44.2	-
	WS6F6-SS-BOP	3/4" - 14 NPTF	316 stainless	3.27	83.1	1.74	44.2	-
1"	WS8F8-BOP	1" - 11-1/2 NPTF	steel	4.18	106.2	2.25	57.2	-
	WS8F8-SS-BOP	1" - 11-1/2 NPTF	316 stainless	4.18	106.2	2.25	57.2	-
1-1/4"	WS10F10-BOP	1-1/4" - 11-1/2 NPTF	steel	5.38	136.7	2.63	66.8	-
	WS10F10-SS-BOP	1-1/4" - 11-1/2 NPTF	316 stainless	5.38	136.7	2.63	66.8	-
1-1/2"	WS12F12-BOP	1-1/2" - 11-1/2 NPTF	steel	5.98	151.9	3.25	82.6	-
	WS12F12-SS-BOP	1-1/2" - 11-1/2 NPTF	316 stainless	5.98	151.9	3.25	82.6	-
2"	WS16F16-BOP	2" - 11-1/2 NPTF	steel	7.05	179.1	4.00	101.6	-
	WS16F16-SS-BOP	2" - 11-1/2 NPTF	316 stainless	7.05	179.1	4.00	101.6	-

Hydraulic Couplings: T-Series

Interchange Data

- High-pressure 10K thread-together interchange
- Parker/Pioneer 3000-Series, Enerpac C604, Stucchi IVHP
- Eaton WS56000 and DNP PVM
- Interchangeable to ISO 14540

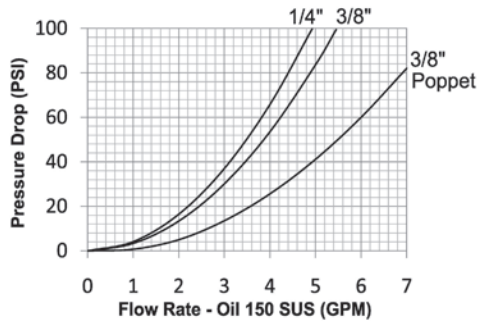

Seal Components

- Nitrile O-ring with TPC-ET back-up ring is standard, providing a temperature range of **-40°F to 250°F** (**-40°C to 121°C**)

Materials

- Machined components are manufactured using solid steel or 316 stainless steel bar stock
- Chrome steel ball valve is mechanically seated to improve pressure sealing performance
- Steel plugs are machined from solid high strength steel bar stock
- Steel componentry is plated using ROHS-compliant trivalent chrome

Rated Pressure Chart

Body Size	T-Series 10K Threaded (Connected)															
	Steel Ball Coupler/Plug				316 SS Ball Coupler/Plug				Steel Poppet Coupler/Plug				316 SS Poppet Coupler/Plug			
	Max. Working		Burst		Max. Working		Burst		Max. Working		Burst		Max. Working		Burst	
	PSI	Bar	PSI	Bar	PSI	Bar	PSI	Bar	PSI	Bar	PSI	Bar	PSI	Bar	PSI	Bar
1/4"	10,000	700	34,300	2,350	-	-	-	-	-	-	-	-	-	-	-	-
3/8"	10,000	700	30,000	2,050	10,000	700	30,900	2,100	10,000	700	36,800	2,500	10,000	700	36,500	2,500

Technical Specifications

Body Size	Interchange Standards				Functional Parameters				
	U.S. Military	U.S. Government	International Standards	ANSI/NFPA Standards	Valve Style	Air Inclusion	Fluid Loss	Vacuum inch HG	Flow $\Delta P = 60$ PSI
1/4"	-	-	ISO14540	-	ball	0.97	0.56	N/R	3.8 GPM
3/8"	-	-	ISO14540	-	ball	2.04	0.98	N/R	4.2 GPM
	-	-	ISO14540	-	poppet	1.56	0.77	N/R	6.0 GPM

Available Options

Body Size	Seal Options		Kalrez® Seal Options			Valve Options		Treatments
	FKM	Mil-Nitrile	4079	6375	7075	Unvalved	316 SS	Oxy-Clean
1/4"	F-	M-	K4-	K6-	K7-	-E	N/A	-C1
3/8"	F-	M-	K4-	K6-	K7-	-E	N/A	-C1

T-Series Profiles

Body Size	A	B
1/4"	0.62	0.44
3/8"	0.37	0.63

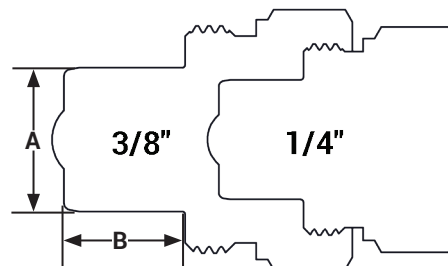

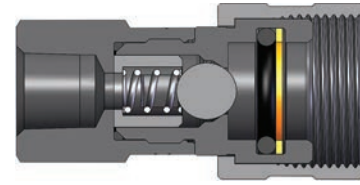

T-Series 10K Threaded Ball Coupler (Female Threads)

Body Size	T-Series 10K Threaded Ball Coupler (Female Threads)							
	Part Detail			Length		Maximum O.D.		Hex inch
	Part #	Threads	Material	inch	mm	inch	mm	
1/4"	2TF2	1/4" - 18 NPTF	steel	2.09	53.09	1.13	28.70	13/16"
3/8"	3TF3	3/8" - 18 NPTF	steel	2.54	64.60	1.37	34.70	1"

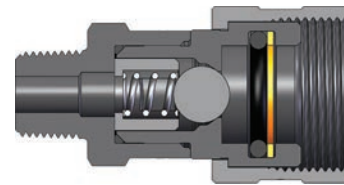

T-Series 10K Threaded Ball Coupler (Male Threads)

Body Size	T-Series 10K Threaded Ball Coupler (Male Threads)							
	Part Detail			Length		Maximum O.D.		Hex inch
	Part #	Threads	Material	inch	mm	inch	mm	
1/4"	2TM2	1/4" - 18 NPTF	steel	2.16	54.9	1.13	28.6	13/16"
3/8"	3TM3	3/8" - 18 NPTF	steel	2.59	65.8	1.37	34.7	1"
	3TM3-SS	3/8" - 18 NPT	316 stainless	2.59	65.8	1.37	34.7	1"

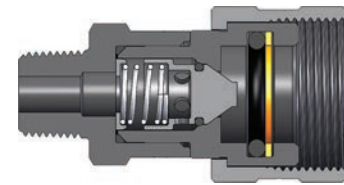

T-Series 10K Threaded Poppet Coupler (Male Threads)

Body Size	T-Series 10K Threaded Poppet Coupler (Male Threads)							
	Part Detail			Length		Maximum O.D.		Hex inch
	Part #	Threads	Material	inch	mm	inch	mm	
3/8"	3TM3-PV	3/8" - 18 NPT	steel	2.78	70.7	1.36	34.5	1"
	3TM3-SS-PV	3/8" - 18 NPT	316 stainless	2.78	70.7	1.36	34.5	1"

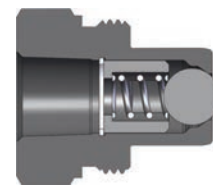

T-Series 10K Threaded Ball Plug (Female Threads)

Body Size	T-Series 10K Threaded Ball Plug (Female Threads)							
	Part Detail			Length		Maximum O.D.		Hex inch
	Part #	Threads	Material	inch	mm	inch	mm	
1/4"	T2F2	1/4" - 18 NPTF	steel	1.29	32.9	1.07	27.2	1-1/16"
3/8"	T3F3	3/8" - 18 NPTF	steel	1.56	39.7	1.35	34.3	1-1/4"
	T3F3-SS	3/8" - 18 NPT	316 stainless	1.56	39.7	1.35	34.3	1-1/4"

Hydraulic Couplings: T-Series

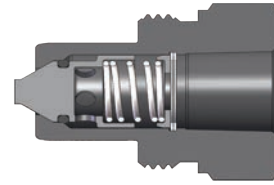
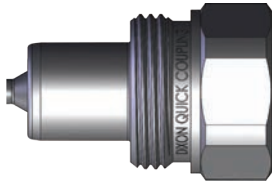

Body Size	T-Series 10K Threaded Poppet Plug (Female Threads)							
	Part Detail			Length		Maximum O.D.		Hex inch
	Part #	Threads	Material	inch	mm	inch	mm	
3/8"	T3F3-PV	3/8" - 18 NPT	steel	1.53	38.9	1.19	30.2	15/16"
	T3F3-SS-PV	3/8" - 18 NPT	316 stainless	1.53	38.9	1.19	30.2	15/16"



Body Size	T-Series Coupler Rigid Dust Plug		
	Part Detail		
	Part #	Lanyard	Body
1/4"	2TDP	rubber	steel
3/8"	3TDP	rubber	steel



Body Size	T-Series Plug Rigid Dust Cap		
	Part Detail		
	Part #	Lanyard	Body
1/4"	T2DC	steel cable	steel
3/8"	T3DC	steel cable	steel

Body Size	T-Series 10K Threaded Coupler Seal Kits			
	Part Detail			Seal Kit Contents
	Part #	Coupler Style	Seal Material	
1/4"	2T-SKIT	ball valve	Nitrile	Nitrile o-ring with TPC-ET back-up ring
3/8"	3T-SKIT	ball valve	Nitrile	Nitrile o-ring with TPC-ET back-up ring

Interchange Data

- Interchangeable with ISO14541 1/4" - 3/4"
- European screw-together interchange
- Inteva STG-Series, Faster CVV-Series, DNP PVV3, Voswinkel Type-HS

Materials

- Machined components are manufactured using solid steel bar stock
- Steel retaining rings and springs maximize service life in rugged environments
- Steel componentry is plated using ROHS-compliant trivalent chrome

Seal Components

- Nitrile seals are standard, providing a temperature range of -13°F to 257°F (-25°C to 125°C)
- Plugs have a PTFE anti-extrusion ring to prevent O-ring damage during dynamic impulse service

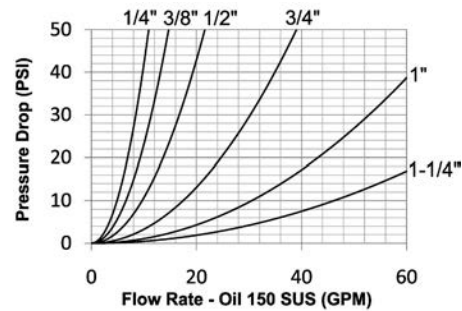

Rated Pressure Chart

Body Size	CVV-Series European Screw-Together Interchange			
	Coupler/Plug Coupled			
	Maximum Working		Burst	
	PSI	Bar	PSI	Bar
1/4"	6,500	450	26,000	1,800
3/8"	6,500	450	26,000	1,800
1/2"	5,800	400	23,200	1,600
3/4"	5,800	400	23,200	1,600
1"	4,400	300	17,600	1,200
1-1/4"	4,400	300	17,600	1,200

Technical Specifications

Body Size	Interchange Standards				Functional Parameters				
	U.S. Military	U.S. Government	International Standards	ANSI/NFPA Standards	Locking Mechanism	Air Inclusion	Fluid Loss	Vacuum Inch HG	Flow $\Delta P = 22$ PSI
1/4"	-	-	ISO14541	-	Threaded	N/A	N/A	27.4	7 GPM
3/8"	-	-	ISO14541	-	Threaded	N/A	N/A	27.4	10 GPM
1/2"	-	-	ISO14541	-	Threaded	N/A	N/A	27.4	15 GPM
3/4"	-	-	ISO14541	-	Threaded	N/A	N/A	27.4	26 GPM
1"	-	-	-	-	Threaded	N/A	N/A	27.4	45 GPM
1-1/4"	-	-	-	-	Threaded	N/A	N/A	27.4	70 GPM

NOTE: Threaded sleeves enable easy connection and disconnection while system is under residual pressure only.

Hydraulic Couplings: CVV-Series

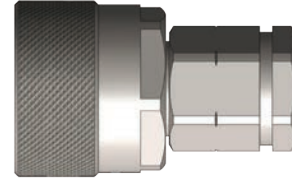
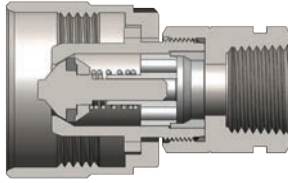

Body Size	CVV-Series European Interchange Coupler (Female Threads)							
	Part Detail			Length		Maximum O.D.		Hex mm
	Part #	Threads	Material	inch	mm	inch	mm	
1/4"	2CVVF2	1/4" - 18 NPTF	steel	2.33	59.3	1.34	34.0	19
	2CVVBF2	1/4" - 19 BSPP	steel	2.33	59.3	1.34	34.0	19
	2CVVFM1415	M14X1.5	steel	2.33	59.3	1.34	34.0	19
3/8"	3CVVF3	3/8" - 18 NPTF	steel	2.41	61.2	1.34	34.0	22
	3CVVBF3	3/8" - 19 BSPP	steel	2.41	61.2	1.34	34.0	22
	3CVVFM1615	M16X1.5	steel	2.41	61.2	1.34	34.0	22
1/2"	4CVVF4	1/2" - 14 NPTF	steel	2.66	67.5	1.65	41.8	27
	4CVVOF4	3/4" - 16 ORB	steel	2.66	67.5	1.65	41.8	27
	4CVVBF4	1/2" - 14 BSPP	steel	2.66	67.5	1.65	41.8	27
	4CVVFM1815	M18X1.5	steel	2.66	67.5	1.65	41.8	27
	4CVVOF5	7/8" - 14ORB	steel	2.66	67.5	1.65	41.8	27
	4CVVFM2215	M22X1.5	steel	2.66	67.5	1.65	41.8	27
3/4"	6CVVF6	3/4" - 14 NPTF	steel	3.15	80.0	1.89	48.0	36
	6CVVBF6	3/4" - 14 BSPP	steel	3.15	80.0	1.89	48.0	36
	6CVVFM2215	M22X1.5	steel	3.15	80.0	1.89	48.0	36
1"	8CVVF8	1" - 11-1/2 NPTF	steel	3.30	83.9	2.35	59.8	41
	8CVVBF8	1" - 11 BSPP	steel	3.30	83.9	2.35	59.8	41
1-1/4"	10CVVF10	1-1/4" - 11-1/2 NPTF	steel	5.59	142.0	3.14	79.8	50
	10CVVBF10	1-1/4" - 11 BSPP	steel	5.59	142.0	3.14	79.8	50

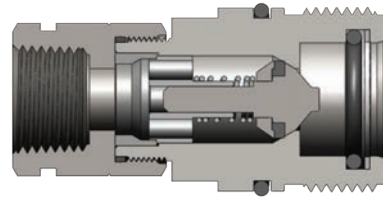
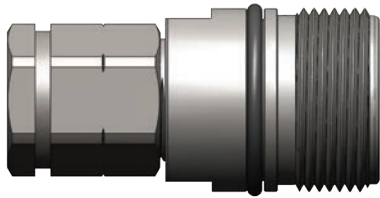

Body Size	CVV-Series European Interchange Plug (Female Threads)							
	Part Detail			Length		Maximum O.D.		Hex mm
	Part #	Threads	Material	inch	mm	inch	mm	
1/4"	CVV2F2	1/4" - 18 NPTF	steel	2.36	60.0	0.94	24.0	19
	CVV2BF2	1/4" - 19 BSPP	steel	2.36	60.0	0.94	24.0	19
	CVV2FM1415	M14X1.5	steel	2.36	60.0	0.94	24.0	19
3/8"	CVV3F3	3/8" - 18 NPTF	steel	2.52	64.0	1.10	28.0	22
	CVV3BF3	3/8" - 19 BSPP	steel	2.52	64.0	1.10	28.0	22
	CVV3FM1615	M16X1.5	steel	2.52	64.0	1.10	28.0	22
1/2"	CVV4F4	1/2" - 14 NPTF	steel	2.76	70.0	1.42	36.0	27
	CVV4OF4	3/4" - 16 ORB	steel	2.76	70.0	1.42	36.0	27
	CVV4BF4	1/2" - 14 BSPP	steel	2.76	70.0	1.42	36.0	27
	CVV4FM1815	M18X1.5	steel	2.76	70.0	1.42	36.0	27
	CVV4OF5	7/8" - 14ORB	steel	2.76	70.0	1.42	36.0	27
	CVV4FM2215	M22X1.5	steel	2.76	70.0	1.42	36.0	27
3/4"	CVV6F6	3/4" - 14 NPTF	steel	3.39	86.0	1.65	42.0	36
	CVV6BF6	3/4" - 14 BSPP	steel	3.39	86.0	1.65	42.0	36
	CVV6FM2215	M22X1.5	steel	3.39	86.0	1.65	42.0	36
1"	CVV8F8	1" - 11-1/2 NPTF	steel	3.94	100.0	1.89	48.0	41
	CVV8BF8	1" - 11 BSPP	steel	3.94	100.0	1.89	48.0	41
1-1/4"	CVV10F10	1-1/4" - 11-1/2 NPTF	steel	5.91	150.0	2.76	70.0	50
	CVV10BF10	1-1/4" - 11 BSPP	steel	5.91	150.0	2.76	70.0	50

Hydraulic Couplings: CVV-Series



Body Size	CVV-Series European Interchange Dust Plug		
	Part Detail		
	Part #	Lanyard	Body
1/4"	2CVVDP	plastic	plastic
3/8"	3CVVDP	plastic	plastic
1/2"	4CVVDP	plastic	plastic
3/4"	6CVVDP	plastic	plastic
1"	8CVVDP	plastic	plastic
1-1/4"	10CVVDP	plastic	plastic



Body Size	CVV-Series European Interchange Dust Cap		
	Part Detail		
	Part #	Lanyard	Body
1/4"	CVV2DC	plastic	plastic
3/8"	CVV3DC	plastic	plastic
1/2"	CVV4DC	plastic	plastic
3/4"	CVV6DC	plastic	plastic
1"	CVV8DC	plastic	plastic
1-1/4"	CVV10DC	plastic	plastic

CVV-Series Profiles

Body Size	A	B
1/4"	0.94	0.50
3/8"	1.10	0.57
1/2"	1.41	0.66
3/4"	1.64	0.77
1"	1.88	0.77
1-1/4"	2.75	1.28

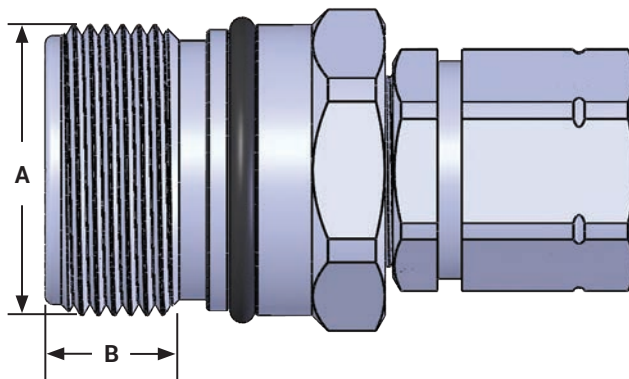

Interchange Data

- Spir Star CQD-Series, DNP CRS-Series, Jetstream Screw Type

Materials

- Machined components are manufactured using 316 stainless steel bar stock
- Stainless steel retaining rings maximize corrosion resistance and extend service life

Seal Components

- Nitrile seals are standard, providing a temperature range of -40°F to 250°F (-40°C to 121°C)
- Couplers have a Nitrile anti-extrusion ring, providing resistance to O-ring dynamic impulse pressure damage

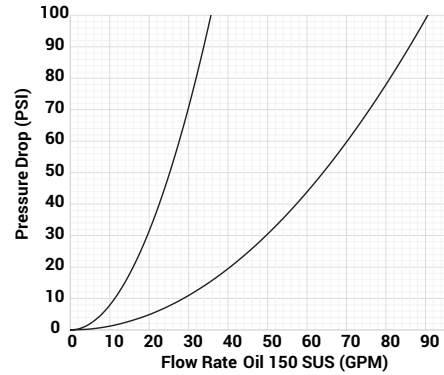

Rated Pressure Chart

Body Size	TD-Series 15K and 20K Threaded Couplings	
	Maximum Working	
	PSI	Bar
1/2" x 1/2" NPTF	15,000	1,034
1/2" x 9/16" MP	20,000	1,379

Technical Specifications

Body Size	Interchange Standards				Functional Parameters				
	U.S. Military	U.S. Government	International Standards	ANSI/NFPA Standards	Threaded	Air Inclusion	Fluid Loss	Vacuum inch HG	Flow $\Delta P = 40$ PSI
1/2"	-	-	-	-	Maxi-Latch	N/A	N/A	N/R	40 GPM

Body Size	A	B
1/2"	.75	.63

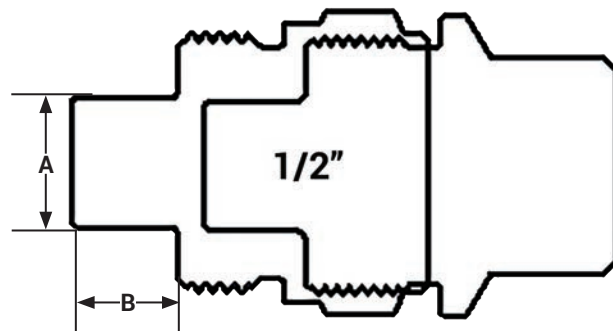

Hydraulic Couplings: TD-Series

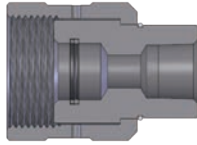

Body Size	TD-Series 15K Threaded Coupler (Female Threads)							
	Part Detail			Length		Maximum O.D.		Hex mm
	Part #	Threads	Material	inch	mm	inch	mm	
1/2"	4TDF4-SS	1/2" - 14 NPTF	316 stainless	2.57	65.28	1.85	46.99	1.13

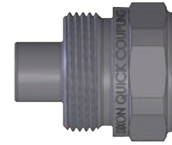
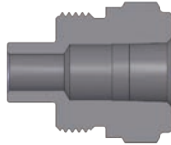

Body Size	TD-Series 15K Threaded Plug (Female Threads)							
	Part Detail			Length		Maximum O.D.		Hex mm
	Part #	Threads	Material	inch	mm	inch	mm	
1/2"	TD4F4-SS	1/2" - 14 NPTF	316 stainless	2.06	52.32	1.75	44.45	1.63



Body Size	TD-Series 20K Threaded Coupler (Female MP Threads)							
	Part Detail			Length		Maximum O.D.		Hex mm
	Part #	Threads	Material	inch	mm	inch	mm	
1/2"	4TDPF4.5-SS	9/16" MP	316 stainless	2.85	72.39	1.88	47.75	1.13

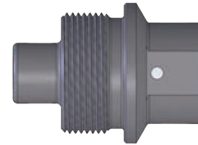
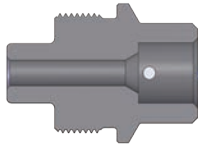

Body Size	TD-Series 20K Threaded Plug (Female MP Threads)							
	Part Detail			Length		Maximum O.D.		Hex mm
	Part #	Threads	Material	inch	mm	inch	mm	
1/2"	TD4PF4.5-SS	9/16" MP	316 stainless	2.40	60.96	1.74	44.20	1.13

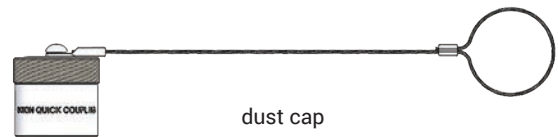
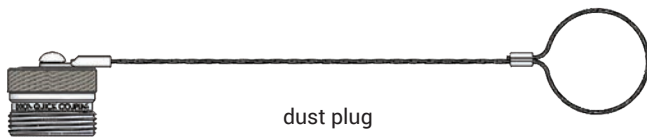

Body Size	TD-Series Dust Cap and Dust Plug							
	Part Detail				Length		Maximum OD	
	Part #	Description	Threads	Material	inch	mm	inch	mm
1/2"	TD4DC-A	dust cap	1/2" - 14 NPTF	aluminum	10	254	1.73	43.94
	TD4.5DC-A	dust cap	9/16" MP	aluminum	10	254	1.69	42.93
	4TDDP-A	dust plug	1/2" - 14 NPTF	aluminum	10	254	1.50	38.10
	4.5TDDP-A	dust plug	9/16" MP	aluminum	10	254	1.50	38.10

Interchange Data

- Straight-through pressure-wash interchange
- Parker ST-Series, Foster FST-Series, Hansen ST-Series

Seal Components

- Nitrile seals are standard, providing a temperature range of -40°F to 250°F (-40°C to 121°C)

Materials

- Machined components are manufactured using solid steel, brass, or 303 stainless steel bar stock
- Stainless steel balls, retaining rings, and springs maximize corrosion resistance and extend service life
- Steel componentry is plated using ROHS-compliant trivalent chrome
- 1-1/4" to 2" brass couplers have steel sleeves as standard to maximize service life, hardened to resist deformation
- Steel plugs are hardened to provide heavy-duty performance

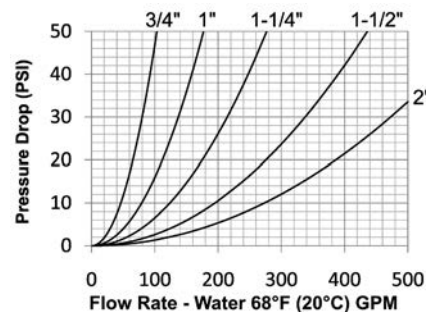
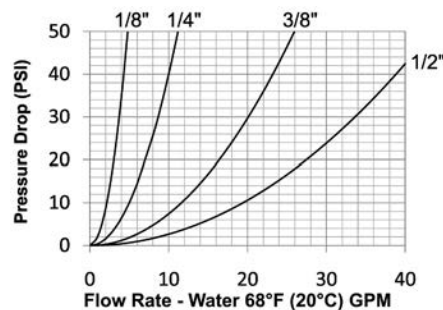

Rated Pressure Chart

Body Size	E-Series Straight-Through Interchange (Connected)											
	Brass Coupler/Steel Plug				Brass Coupler/Plug				303 Stainless Steel Coupler/Plug			
	Max. Working		Burst		Max. Working		Burst		Max. Working		Burst	
	PSI	Bar	PSI	Bar	PSI	Bar	PSI	Bar	PSI	Bar	PSI	Bar
1/8"	2,600	179	10,400	717	2,500	172	10,000	689	4,200	290	16,800	1,158
1/4"	5,500	379	22,000	1,517	5,200	359	20,800	1,434	6,700	462	26,800	1,848
3/8"	3,500	241	14,000	966	2,700	186	10,800	745	5,500	379	22,000	1,517
1/2"	2,700	186	10,800	745	2,200	152	8,800	607	3,000	207	12,000	827
3/4"	2,700	186	10,800	745	1,700	117	6,800	469	3,000	207	12,000	827
1"	2,000	138	8,000	552	1,200	83	4,800	331	1,700	117	6,800	469
1-1/4"	2,000	138	8,000	552	1,700	117	6,800	469	2,000	138	8,000	552
1-1/2"	2,000	138	8,000	552	1,400	97	5,600	386	2,000	138	8,000	552
2"	2,000	138	8,000	552	1,400	97	5,600	386	2,000	138	8,000	552

Technical Specifications

Body Size	Interchange Standards				Functional Parameters				
	U.S. Military	U.S. Government	International Standards	ANSI/NFPA Standards	Locking Ball Quantity	Air Inclusion	Fluid Loss	Vacuum inch HG	Flow ΔP = 15 PSI
1/8"	-	-	-	-	6	N/A	N/A	N/R	3 GPM
1/4"	-	-	-	-	6	N/A	N/A	N/R	6 GPM
3/8"	-	-	-	-	8	N/A	N/A	N/R	14 GPM
1/2"	-	-	-	-	8	N/A	N/A	N/R	24 GPM
3/4"	-	-	-	-	8	N/A	N/A	N/R	58 GPM
1"	-	-	-	-	8	N/A	N/A	N/R	100 GPM
1-1/4"	-	-	-	-	8	N/A	N/A	N/R	150 GPM
1-1/2"	-	-	-	-	8	N/A	N/A	N/R	250 GPM
2"	-	-	-	-	8	N/A	N/A	N/R	350 GPM

Available Options

Body Size	Standard Seal Options				Kalrez® Seal Options			Other Options	
	FKM	EPDM	Mil-Nitrile	Silicone	4079	6375	7075	Sleeve-Lock	Oxy-Clean
1/8"	F-	P-	M-	S-	N/A	N/A	N/A	-LS	-C1
1/4"	F-	P-	M-	S-	N/A	N/A	N/A	-LS	-C1
3/8"	F-	P-	M-	S-	N/A	N/A	N/A	-LS	-C1
1/2"	F-	P-	M-	S-	N/A	N/A	N/A	-LS	-C1
3/4"	F-	P-	M-	S-	N/A	N/A	N/A	-LS	-C1
1"	F-	P-	M-	S-	N/A	N/A	N/A	-LS	-C1
1-1/4"	F-	P-	M-	S-	N/A	N/A	N/A	-LS	-C1
1-1/2"	F-	P-	M-	S-	N/A	N/A	N/A	-LS	-C1
2"	F-	P-	M-	S-	N/A	N/A	N/A	-LS	-C1

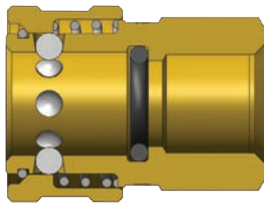

Body Size	E-Series Straight-Through Interchange Coupler (Female Threads)							
	Part Detail			Length		Maximum O.D.		Hex inch
	Part #	Threads	Material	inch	mm	inch	mm	
1/8"	1EF1-B	1/8" - 27 NPTF	brass	1.01	25.7	0.65	16.5	9-16"
	1EF1-S	1/8" - 27 NPTF	303 stainless	1.01	25.7	0.65	16.5	9/16"
1/4"	2EF2-B	1/4" - 18 NPTF	brass	1.40	35.6	0.96	24.4	13/16"
	2EF2-S	1/4" - 18 NPTF	303 stainless	1.40	35.6	0.96	24.4	13/16"
	2EBF2-B	1/4" - 19 BSPP	brass	1.40	35.6	0.96	24.4	13/16"
3/8"	3EF3-B	3/8" - 18 NPTF	brass	1.60	40.6	1.13	28.7	1"
	3EF3-S	3/8" - 18 NPTF	303 stainless	1.60	40.6	1.13	28.7	1"
	3EBF3-B	3/8" - 19 BSPP	brass	1.60	40.6	1.13	28.7	1"
1/2"	4EF4-B	1/2" - 14 NPTF	brass	1.96	49.8	1.27	32.3	1-1/8"
	4EF4-S	1/2" - 14 NPTF	303 stainless	1.96	49.8	1.27	32.3	1-1/8"
	4EBF4-B	1/2" - 14 BSPP	brass	1.96	49.8	1.27	32.3	1-1/8"
3/4"	6EF6-B	3/4" - 14 NPTF	brass	2.10	53.3	1.65	41.9	1-1/2"
	6EF6-S	3/4" - 14 NPTF	303 stainless	2.10	53.3	1.65	41.9	1-1/2"
	6EBF6-B	3/4" - 14 BSPP	brass	2.10	53.3	1.65	41.9	1-1/2"
1"	8EF8-B	1" - 11-1/2 NPTF	brass	2.36	59.9	2.02	51.3	1-3/4"
	8EF8-S	1" - 11-1/2 NPTF	303 stainless	2.36	59.9	2.02	51.3	1-3/4"
	8EBF8-B	1" - 11 BSPP	brass	2.36	59.9	2.02	51.3	1-3/4"
1-1/4"	10EF10-B	1-1/4" - 11-1/2 NPTF	brass	2.36	59.9	2.59	65.8	2-1/4"
	10EF10-S	1-1/4" - 11-1/2 NPTF	303 stainless	2.36	59.9	2.59	65.8	2-1/4"
1-1/2"	12EF12-B	1-1/2" - 11-1/2 NPTF	brass	2.89	73.4	3.18	80.8	2-3/4"
	12EF12-S	1-1/2" - 11-1/2 NPTF	303 stainless	2.89	73.4	3.18	80.8	2-3/4"
2"	16EF16-B	2" - 11-1/2 NPTF	brass	3.00	76.2	4.04	102.6	3-1/2"
	16EF16-S	2" - 11-1/2 NPTF	303 stainless	3.00	76.2	4.04	102.6	3-1/2"

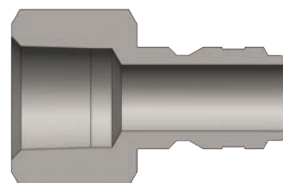

Body Size	E-Series Straight-Through Interchange Plug (Female Threads)							
	Part Detail			Length		Maximum O.D.		Hex inch
	Part #	Threads	Material	inch	mm	inch	mm	
1/8"	E1F1	1/8" - 27 NPTF	steel	0.98	24.9	0.65	16.5	9/16"
	E1F1-B	1/8" - 27 NPTF	brass	0.98	24.9	0.65	16.5	9/16"
	E1F1-S	1/8" - 27 NPTF	303 stainless	0.98	24.9	0.65	16.5	9/16"
1/4"	E2F2	1/4" - 18 NPTF	steel	1.47	37.3	0.79	20.1	11/16"
	E2F2-B	1/4" - 18 NPTF	brass	1.47	37.3	0.79	20.1	11/16"
	E2F2-S	1/4" - 18 NPTF	303 stainless	1.47	37.3	0.79	20.1	11/16"
	E2BF2-B	1/4" - 19 BSPP	brass	1.47	37.3	0.79	20.1	11/16"
3/8"	E3F3	3/8" - 18 NPTF	steel	1.60	40.6	1.01	25.7	7/8"
	E3F3-B	3/8" - 18 NPTF	brass	1.60	40.6	1.01	25.7	7/8"
	E3F3-S	3/8" - 18 NPTF	303 stainless	1.60	40.6	1.01	25.7	7/8"
	E3BF3-B	3/8" - 19 BSPP	brass	1.60	40.6	1.01	25.7	7/8"
1/2"	E4F4	1/2" - 14 NPTF	steel	1.82	46.2	1.16	29.5	1"
	E4F4-B	1/2" - 14 NPTF	brass	1.82	46.2	1.16	29.5	1"
	E4F4-S	1/2" - 14 NPTF	303 stainless	1.82	46.2	1.16	29.5	1"
	E4BF4-B	1/2" - 14 BSPP	brass	1.82	46.2	1.16	29.5	1"
3/4"	E6F6	3/4" - 14 NPTF	steel	2.05	52.1	1.37	34.8	1-3/16"
	E6F6-B	3/4" - 14 NPTF	brass	2.05	52.1	1.37	34.8	1-3/16"
	E6F6-S	3/4" - 14 NPTF	303 stainless	2.05	52.1	1.37	34.8	1-3/16"
	E6BF6-B	3/4" - 14 BSPP	brass	2.05	52.1	1.37	34.8	1-3/16"
1"	E8F8	1" - 11-1/2 NPTF	steel	2.36	59.9	1.73	43.9	1-1/2"
	E8F8-B	1" - 11-1/2 NPTF	brass	2.36	59.9	1.73	43.9	1-1/2"
	E8F8-S	1" - 11-1/2 NPTF	303 stainless	2.36	59.9	1.73	43.9	1-1/2"
	E8BF8-B	1" - 11 BSPP	brass	2.36	59.9	1.73	43.9	1-1/2"
1-1/4"	E10F10	1-1/4" - 11-1/2 NPTF	steel	2.47	62.7	2.31	58.7	2"
	E10F10-B	1-1/4" - 11-1/2 NPTF	brass	2.47	62.7	2.31	58.7	2"
	E10F10-S	1-1/4" - 11-1/2 NPTF	303 stainless	2.47	62.7	2.31	58.7	2"
1-1/2"	E12F12	1-1/2" - 11-1/2 NPTF	steel	2.74	69.6	2.60	66.0	2-1/4"
	E12F12-B	1-1/2" - 11-1/2 NPTF	brass	2.74	69.6	2.60	66.0	2-1/4"
	E12F12-S	1-1/2" - 11-1/2 NPTF	303 stainless	2.74	69.6	2.60	66.0	2-1/4"
2"	E16F16	2" - 11-1/2 NPTF	steel	3.00	76.2	3.03	77.0	2-5/8"
	E16F16-B	2" - 11-1/2 NPTF	brass	3.00	76.2	3.03	77.0	2-5/8"
	E16F16-S	2" - 11-1/2 NPTF	303 stainless	3.00	76.2	3.03	77.0	2-5/8"

Hydraulic Couplings: E-Series

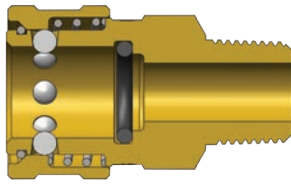

Body Size	E-Series Straight-Through Interchange Coupler (Male Threads)							
	Part Detail			Length		Maximum O.D.		Hex inch
	Part #	Threads	Material	inch	mm	inch	mm	
1/8"	1EM1-B	1/8" - 27 NPTF	brass	1.01	25.7	0.65	16.5	9/16"
	1EM1-S	1/8" - 27 NPTF	303 stainless	1.01	25.7	0.65	16.5	9/16"
1/4"	2EM2-B	1/4" - 18 NPTF	brass	1.66	42.2	0.96	24.4	13/16"
	2EM2-S	1/4" - 18 NPTF	303 stainless	1.66	42.2	0.96	24.4	13/16"
3/8"	3EM3-B	3/8" - 18 NPTF	brass	1.70	43.2	1.13	28.7	1"
	3EM3-S	3/8" - 18 NPTF	303 stainless	1.70	43.2	1.13	28.7	1"
1/2"	4EM4-B	1/2" - 14 NPTF	brass	2.00	50.8	1.27	32.3	1-1/8"
	4EM4-S	1/2" - 14 NPTF	303 stainless	2.00	50.8	1.27	32.3	1-1/8"
3/4"	6EM6-B	3/4" - 14 NPTF	brass	2.24	56.9	1.65	41.9	1-1/2"
	6EM6-S	3/4" - 14 NPTF	303 stainless	2.24	56.9	1.65	41.9	1-1/2"
1"	8EM8-B	1" - 11-1/2 NPTF	brass	2.61	66.3	2.02	51.3	1-3/4"
	8EM8-S	1" - 11-1/2 NPTF	303 stainless	2.61	66.3	2.02	51.3	1-3/4"
1-1/4"	10EM10-B	1-1/4" - 11-1/2 NPTF	brass	2.91	73.9	2.59	65.8	2-1/4"
1-1/2"	12EM12-B	1-1/2" - 11-1/2 NPTF	brass	3.44	87.4	3.18	80.8	2-3/4"
2"	16EM16-B	2" - 11-1/2 NPTF	brass	3.70	94.0	4.04	102.6	3-1/2"

E-Series Profiles

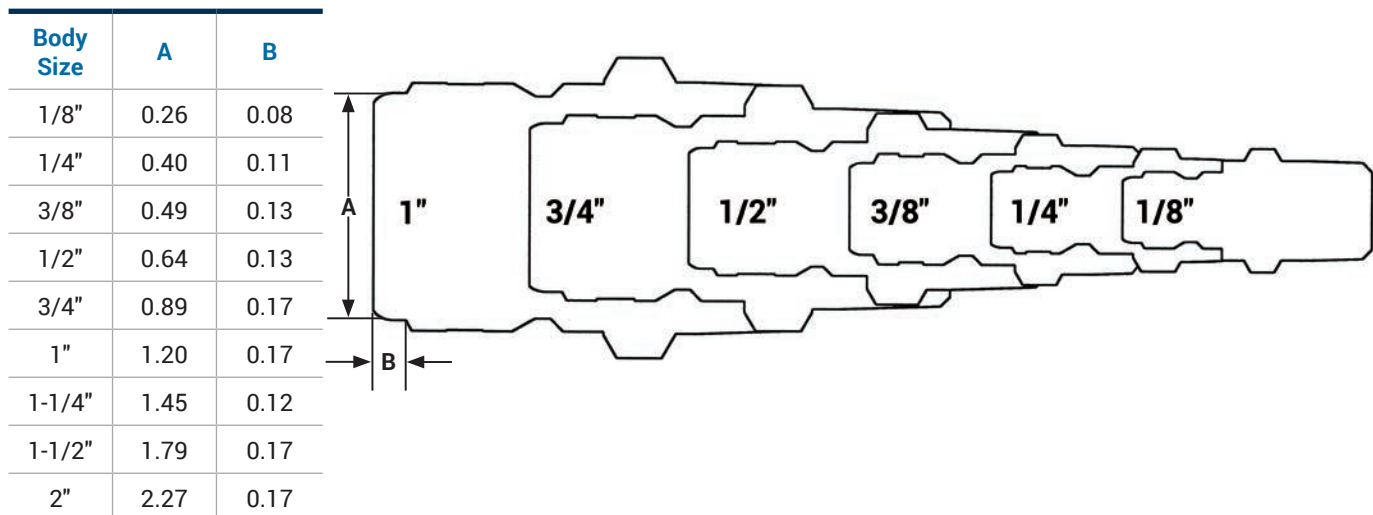

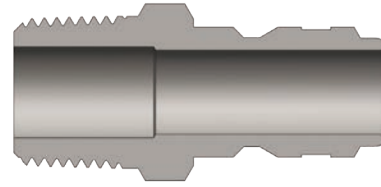
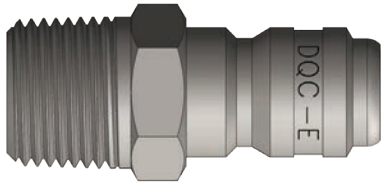

Body Size	E-Series Straight-Through Interchange Plug (Male Threads)							
	Part Detail			Length		Maximum O.D.		Hex inch
	Part #	Threads	Material	inch	mm	inch	mm	
1/8"	E1M1	1/8" - 27 NPTF	steel	1.15	29.2	0.58	14.7	1/2"
	E1M1-B	1/8" - 27 NPTF	brass	1.15	29.2	0.58	14.7	1/2"
	E1M1-S	1/8" - 27 NPTF	303 stainless	1.15	29.2	0.58	14.7	1/2"
1/4"	E2M2	1/4" - 18 NPTF	steel	1.50	38.1	0.65	16.5	9/16"
	E2M2-B	1/4" - 18 NPTF	brass	1.50	38.1	0.65	16.5	9/16"
	E2M2-S	1/4" - 18 NPTF	303 stainless	1.50	38.1	0.65	16.5	9/16"
3/8"	E3M3	3/8" - 18 NPTF	steel	1.69	42.9	0.79	20.1	11/16"
	E3M3-B	3/8" - 18 NPTF	brass	1.69	42.9	0.79	20.1	11/16"
	E3M3-S	3/8" - 18 NPTF	303 stainless	1.69	42.9	0.79	20.1	11/16"
1/2"	E4M4	1/2" - 14 NPTF	steel	1.91	48.5	1.01	25.7	7/8"
	E4M4-B	1/2" - 14 NPTF	brass	1.91	48.5	1.01	25.7	7/8"
	E4M4-S	1/2" - 14 NPTF	303 stainless	1.91	48.5	1.01	25.7	7/8"
3/4"	E6M6	3/4" - 14 NPTF	steel	2.25	57.2	1.23	31.2	1-1/16"
	E6M6-B	3/4" - 14 NPTF	brass	2.25	57.2	1.23	31.2	1-1/16"
	E6M6-S	3/4" - 14 NPTF	303 stainless	2.25	57.2	1.23	31.2	1-1/16"
1"	E8M8	1" - 11-1/2 NPTF	steel	2.45	62.2	1.59	40.4	1-3/8"
	E8M8-B	1" - 11-1/2 NPTF	brass	2.45	62.2	1.59	40.4	1-3/8"
	E8M8-S	1" - 11-1/2 NPTF	303 stainless	2.45	62.2	1.59	40.4	1-3/8"
1-1/4"	E10M10	1-1/4" - 11-1/2 NPTF	steel	2.80	71.1	2.02	51.3	1-3/4"
	E10M10-B	1-1/4" - 11-1/2 NPTF	brass	2.80	71.1	2.02	51.3	1-3/4"
1-1/2"	E12M12	1-1/2" - 11-1/2 NPTF	steel	3.38	85.9	2.60	66.0	2-1/4"
	E12M12-B	1-1/2" - 11-1/2 NPTF	brass	3.38	85.9	2.60	66.0	2-1/4"
2"	E16M16	2" - 11-1/2 NPTF	steel	3.58	90.9	3.03	77.0	2-5/8"
	E16M16-B	2" - 11-1/2 NPTF	brass	3.58	90.9	3.03	77.0	2-5/8"

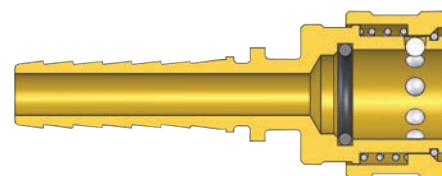
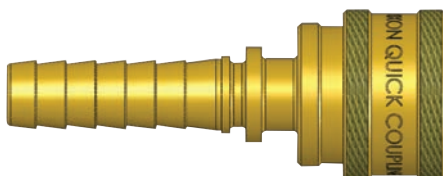

Body Size	E-Series Straight-Through Interchange Coupler (Hose Barb)							
	Part Detail			Length		Maximum O.D.		Hex inch
	Part #	Hose I.D.	Material	inch	mm	inch	mm	
1/4"	2ES2-B	1/4"	brass	2.06	52.2	1.00	25.4	-
3/8"	3ES3-B	3/8"	brass	2.03	51.6	1.13	28.6	-
1/2"	4ES4-B	1/2"	brass	3.45	87.6	1.34	34.0	-
3/4"	6ES6-B	3/4"	brass	3.64	92.3	1.64	41.7	-
1"	8ES8-B	1"	brass	4.58	116.2	1.99	50.5	-

Hydraulic Couplings: E-Series

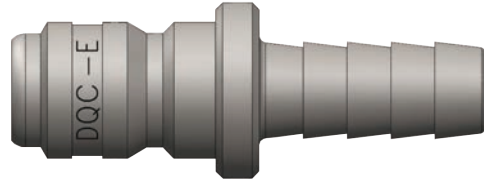
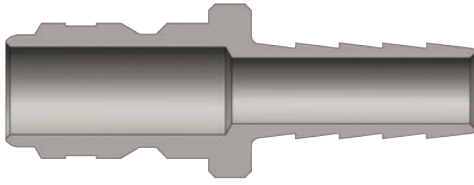

Body Size	E-Series Straight-Through Interchange Plug (Hose Barb)							
	Part Detail			Length		Maximum O.D.		Hex inch
	Part #	Hose I.D.	Material	inch	mm	inch	mm	
1/4"	E2S2	1/4"	steel	1.90	48.3	0.56	14.2	-
	E2S2-B	1/4"	brass	1.90	48.3	0.56	14.2	-
3/8"	E3S3	3/8"	steel	2.03	51.6	0.63	16.0	-
	E3S3-B	3/8"	brass	2.03	51.6	0.63	16.0	-
1/2"	E4S4	1/2"	steel	2.09	53.1	0.75	19.1	-
	E4S4-B	1/2"	brass	2.09	53.1	0.75	19.1	-
3/4"	E6S6	3/4"	steel	2.28	57.9	1.13	28.7	-
	E6S6-B	3/4"	brass	2.28	57.9	1.13	28.7	-
1"	E8S8	1"	steel	3.28	83.3	1.38	35.1	-
	E8S8-B	1"	brass	3.28	83.3	1.38	35.1	-

Body Size	E-Series Straight-Through Interchange Coupler Seal Kits				
	Part Detail			Seal Kit Contents	
	Part #	Coupler Style	Seal Material		
1/4"	2E-SKIT	all	Nitrile	body O-ring	
	F-2E-SKIT	all	FKM	body O-ring	
	P-2E-SKIT	all	EPDM	body O-ring	
3/8"	3E-SKIT	all	Nitrile	body O-ring	
	F-3E-SKIT	all	FKM	body O-ring	
	P-3E-SKIT	all	EPDM	body O-ring	
1/2"	4E-SKIT	all	Nitrile	body O-ring	
	F-4E-SKIT	all	FKM	body O-ring	
	P-4E-SKIT	all	EPDM	body O-ring	
3/4"	6E-SKIT	all	Nitrile	body O-ring	
	F-6E-SKIT	all	FKM	body O-ring	
	P-6E-SKIT	all	EPDM	body O-ring	
1"	8E-SKIT	all	Nitrile	body O-ring	
	F-8E-SKIT	all	FKM	body O-ring	
	P-8E-SKIT	all	EPDM	body O-ring	
1-1/4"	10E-SKIT	all	Nitrile	body O-ring	
	F-10E-SKIT	all	FKM	body O-ring	
	P-10E-SKIT	all	EPDM	body O-ring	
1-1/2"	12E-SKIT	all	Nitrile	body O-ring	
	F-12E-SKIT	all	FKM	body O-ring	
	P-12E-SKIT	all	EPDM	body O-ring	
2"	16E-SKIT	all	Nitrile	body O-ring	
	F-16E-SKIT	all	FKM	body O-ring	
	P-16E-SKIT	all	EPDM	body O-ring	

Interchange Data

- Water-blast interchange
- Parker Series-WB and Eaton/Aeroquip FD69

Seal Components

- Nitrile seals are standard, providing a temperature range of -40°F to 250°F (-40°C to 121°C)
- Couplers have a PTFE anti-extrusion ring, providing resistance to O-ring dynamic impulse pressure damage

Materials

- Machined components are manufactured using solid high strength steel bar stock
- Stainless steel springs and retaining rings maximize corrosion resistance and extend service life
- Latches are manufactured from high-strength steel and plated with electroless nickel
- Steel plugs are machined from solid high strength steel bar stock and hardened
- Machined steel componentry is plated using ROHS-compliant trivalent chrome

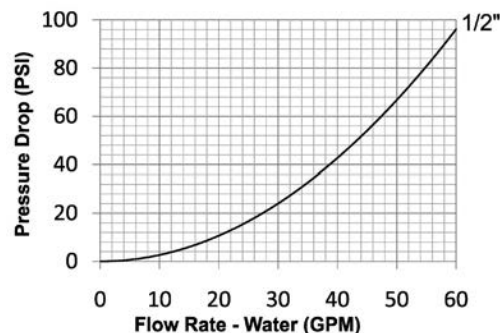

Rated Pressure Chart

Body Size	EA-Series Water-Blast Interchange (Connected)			
	Coupler/Plug			
	Maximum Working		Burst	
	PSI	Bar	PSI	Bar
1/2"	10,000	700	30,000	2,100

Technical Specifications

Body Size	Interchange Standards				Functional Parameters				
	U.S. Military	U.S. Government	International Standards	ANSI/NFPA Standards	Locking Mechanism	Air Inclusion	Fluid Loss	Vacuum inch HG	Flow ΔP = 40 PSI
1/2"	-	-	-	-	Maxi-Latch	N/A	N/A	N/R	40 GPM

Available Options

Body Size	Standard Seal Options					Kalrez® Seal Options			Other Options	
	FKM	EPDM	FDA FKM	Mil-Nitrile	Silicone	4079	6375	7075	No Pin-Lock	Oxy-Clean
	Pre	Pre	Pre	Pre	Pre	Pre	Pre	Pre	Suf	Suf
1/2"	F-	P-	D-	M-	S-	K4-	K6-	K7-	-NL	-C1

Hydraulic Couplings: EA-Series

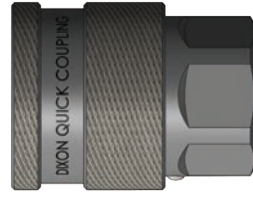
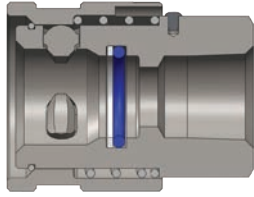

Body Size	EA-Series Water-Blast Interchange Coupler (Female Threads)							
	Part Detail			Length		Maximum O.D.		Hex inch
	Part #	Threads	Material	inch	mm	inch	mm	
1/2"	4EAF3	3/8" - 18 NPTF	steel	2.20	55.9	1.62	41.1	1-1/4"
	4EAF4	1/2" - 14 NPTF	steel	2.20	55.9	1.62	41.1	1-1/4"

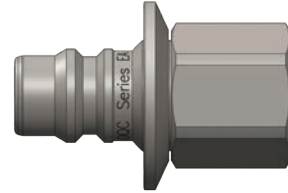
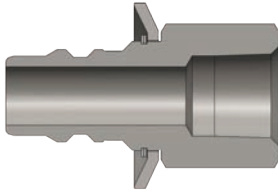

Body Size	EA-Series Water-Blast Interchange Plug (Female Threads)							
	Part Detail			Length		Maximum O.D.		Hex inch
	Part #	Threads	Material	inch	mm	inch	mm	
1/2"	EA4F3	3/8" - 18 NPTF	steel	2.35	59.7	1.62	41.1	1-1/8"
	EA4F4	1/2" - 14 NPTF	steel	2.35	59.7	1.62	41.1	1-1/8"

Body Size	EA-Series Water-Blast Interchange Coupler Seal Kits			
	Part Detail			Seal Kit
	Part #	Coupler Style	Seal Material	Contents
1/2"	4EA-SKIT	all	Nitrile	body O-ring and PTFE back-up
	F-4EA-SKIT	all	FKM	body O-ring and PTFE back-up
	P-4EA-SKIT	all	EPDM	body O-ring and PTFE back-up

EA-Series Profile

Body Size	A	B
1/2"	0.69	0.35

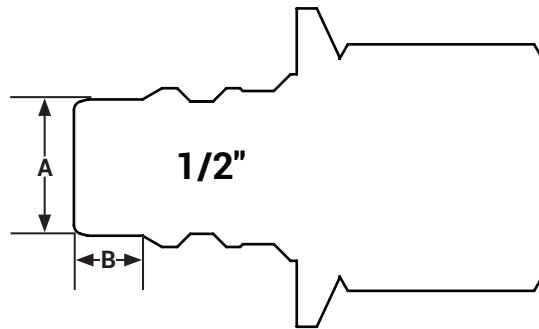

Interchange Data

- Mold coolant interchange
- Foster Series-FJT, Hansen Flo-Temp, Parker Moldmate, DME Jiffy-Tite

Seal Components

- Silicon gaskets and valve O-rings are standard, providing a temperature range of **-90°F to 400°F (-68°C to 205°C)**

Materials

- Machined components are manufactured using solid steel or brass bar stock
- Stainless steel balls, retaining rings, and springs maximize corrosion resistance and extend service life
- Steel componentry is plated using ROHS-compliant trivalent chrome

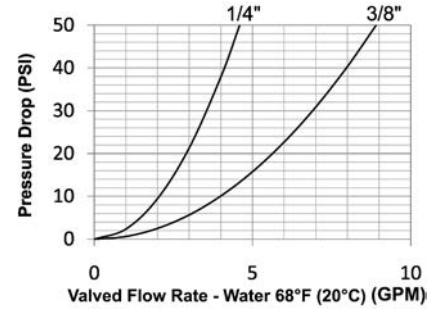
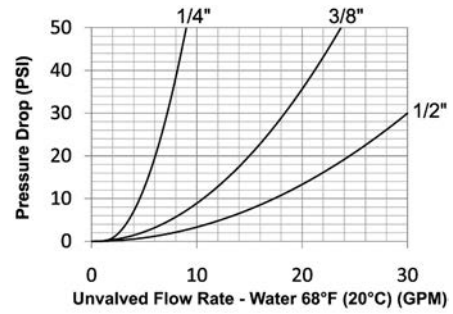

Rated Pressure Chart

Body Size	CM-Series Industrial Mold Interchange (Connected)															
	Unvalved Coupler/Brass Plug				Unvalved Coupler/Steel Plug				Valved Coupler/Brass Plug				Valved Coupler/Steel Plug			
	Max. Working		Burst		Max. Working		Burst		Max. Working		Burst		Max. Working		Burst	
	PSI	Bar	PSI	Bar	PSI	Bar	PSI	Bar	PSI	Bar	PSI	Bar	PSI	Bar	PSI	Bar
1/4"	300	20	10,000	700	500	35	10,700	750	300	20	6,000	400	300	20	6,100	400
3/8"	300	20	14,500	1,000	500	35	14,200	1,000	300	20	6,700	450	300	20	6,100	400
1/2"	300	20	4,900	340	-	-	-	-	-	-	-	-	-	-	-	-

Technical Specifications

Body Size	Interchange Standards				Functional Parameters				
	U.S. Military	U.S. Government	International Standards	ANSI/NFPA Standards	Locking Ball Quantity	Air Inclusion	Fluid Loss	Vacuum inch HG	Flow ΔP = 7 PSI
1/4"	-	-	-	-	6	N/A	N/A	N/R	3 GPM
3/8"	-	-	-	-	8	N/A	N/A	N/R	9 GPM
1/2"	-	-	-	-	8	N/A	N/A	N/R	15 GPM

CM-Series Profiles

Body Size	A	B
1/4"	0.37	0.32
3/8"	0.53	0.49
1/2"	0.78	0.65

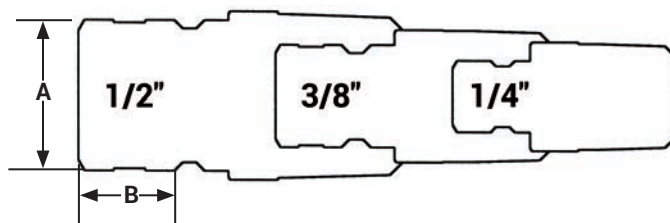

Hydraulic Couplings: CM-Series

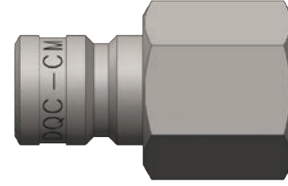
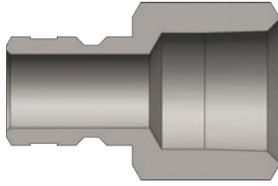

Body Size	CM-Series Industrial Mold Interchange Plug (Female Threads)							
	Part Detail			Length		Maximum O.D.		Hex inch
	Part #	Threads	Material	inch	mm	inch	mm	
1/4"	CM2F1	1/8" - 27 NPTF	steel	0.90	22.9	0.58	14.7	1/2"
	CM2F1-B	1/8" - 27 NPTF	brass	0.90	22.9	0.58	14.7	1/2"
	CM2F2	1/4" - 18 NPTF	steel	1.12	28.4	0.72	18.3	5/8"
	CM2F2-B	1/4" - 18 NPTF	brass	1.12	28.4	0.72	18.3	5/8"
	CM2F3	3/8" - 18 NPTF	steel	1.12	28.4	0.87	22.1	3/4"
	CM2F3-B	3/8" - 18 NPTF	brass	1.12	28.4	0.87	22.1	3/4"
3/8"	CM3F2	1/4" - 18 NPTF	steel	1.34	34.0	0.72	18.3	5/8"
	CM3F2-B	1/4" - 18 NPTF	brass	1.34	34.0	0.72	18.3	5/8"
	CM3F3	3/8" - 18 NPTF	steel	1.34	34.0	0.87	22.1	3/4"
	CM3F3-B	3/8" - 18 NPTF	brass	1.34	34.0	0.87	22.1	3/4"
1/2"	CM4F4-B	1/2" - 14 NPTF	brass	1.69	42.9	1.16	29.5	1"
	CM4F6-B	3/4" - 14 NPTF	brass	1.69	42.9	1.37	34.8	1-3/16"

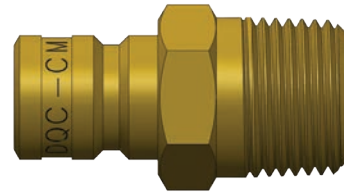
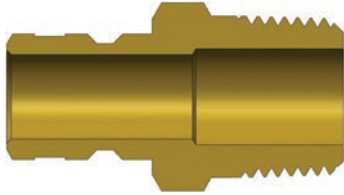

Body Size	CM-Series Industrial Mold Interchange Plug (Male Threads)							
	Part Detail			Length		Maximum O.D.		Hex inch
	Part #	Threads	Material	inch	mm	inch	mm	
1/4"	CM2M1-B	1/8" - 27 NPTF	brass	1.00	25.4	0.65	16.5	9/16"
	CM2M2-B	1/4" - 18 NPTF	brass	1.26	32.0	0.65	16.5	9/16"
	CM2M3-B	3/8" - 18 NPTF	brass	1.20	30.5	0.79	20.1	11/16"
3/8"	CM3M2-B	1/4" - 18 NPTF	brass	1.37	34.8	0.65	16.5	9/16"
	CM3M3-B	3/8" - 18 NPTF	brass	1.43	36.3	0.79	20.1	11/16"
	CM3M4-B	1/2" - 14 NPTF	brass	1.58	40.1	1.01	25.7	7/8"
1/2"	CM4M4-B	1/2" - 14 NPTF	brass	1.69	42.9	1.01	25.7	7/8"
	CM4M6-B	3/4" - 14 NPTF	brass	1.79	45.5	1.23	31.2	1-1/16"



Body Size	CM-Series Industrial Mold Interchange Extension Plug (Male Threads)							
	Part Detail			Length		Maximum O.D.		Hex inch
	Part #	Threads	Material	inch	mm	inch	mm	
1/4"	CM2M1-B-L2.5	1/8" - 27 NPTF	brass	2.50	63.5	0.51	13.0	7/16"
	CM2M1-B-L4	1/8" - 27 NPTF	brass	4.00	101.6	0.51	13.0	7/16"
	CM2M1-B-L5.5	1/8" - 27 NPTF	brass	5.50	139.7	0.51	13.0	7/16"
	CM2M2-B-L2.5	1/4" - 18 NPTF	brass	2.50	63.5	0.65	16.5	9/16"
	CM2M2-B-L4	1/4" - 18 NPTF	brass	4.00	101.6	0.65	16.5	9/16"
	CM2M2-B-L5.5	1/4" - 18 NPTF	brass	5.50	139.7	0.65	16.5	9/16"
	CM2M2-B-L7	1/4" - 18 NPTF	brass	7.00	177.8	0.65	16.5	9/16"
3/8"	CM3M1-B-L2.5	1/8" - 27 NPTF	brass	2.50	63.5	0.65	16.5	9/16"
	CM3M1-B-L4	1/8" - 27 NPTF	brass	4.00	101.6	0.65	16.5	9/16"
	CM3M1-B-L5.5	1/8" - 27 NPTF	brass	5.50	139.7	0.65	16.5	9/16"
	CM3M1-B-L7	1/8" - 27 NPTF	brass	7.00	177.8	0.65	16.5	9/16"
	CM3M2-B-L2.5	1/4" - 18 NPTF	brass	2.50	63.5	0.65	16.5	9/16"
	CM3M2-B-L4	1/4" - 18 NPTF	brass	4.00	101.6	0.65	16.5	9/16"
	CM3M2-B-L5.5	1/4" - 18 NPTF	brass	5.50	139.7	0.65	16.5	9/16"
	CM3M2-B-L7	1/4" - 18 NPTF	brass	7.00	177.8	0.65	16.5	9/16"
	CM3M2-B-L8.5	1/4" - 18 NPTF	brass	8.50	215.9	0.65	16.5	9/16"
	CM3M2-B-L11.5	1/4" - 18 NPTF	brass	11.50	292.1	0.65	16.5	9/16"

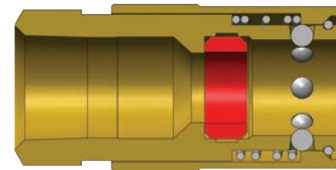

Body Size	CM-Series Industrial Mold Interchange Unvalved Coupler (Female Threads)							
	Part Detail			Length		Maximum O.D.		Hex inch
	Part #	Threads	Material	inch	mm	inch	mm	
1/4"	2CMF1-B-E	1/8" - 27 NPTF	brass	1.35	34.3	0.69	17.5	9/16"
	2CMF2-B-E	1/4" - 18 NPTF	brass	1.35	34.3	0.79	20.1	11/16"
3/8"	3CMF2-B-E	1/4" - 18 NPTF	brass	1.84	46.7	0.95	24.1	3/4"
	3CMF3-B-E	3/8" - 18 NPTF	brass	1.84	46.7	1.01	25.7	7/8"
1/2"	4CMF4-B-E	1/2" - 14 NPTF	brass	2.02	51.3	1.24	31.5	1-1/8"

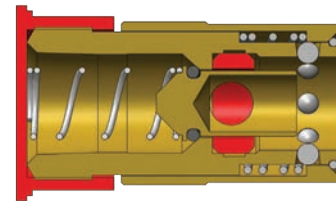
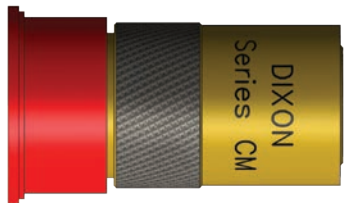

Body Size	CM-Series Industrial Mold Interchange Valved Coupler (Female Threads)							
	Part Detail			Length		Maximum O.D.		Hex inch
	Part #	Threads	Material	inch	mm	inch	mm	
1/4"	2CMF1-B	1/8" - 27 NPTF	brass	1.35	34.3	0.69	17.5	9/16"
3/8"	3CMF2-B	1/4" - 18 NPTF	brass	1.84	46.7	0.95	24.1	3/4"

Hydraulic Couplings: CM-Series

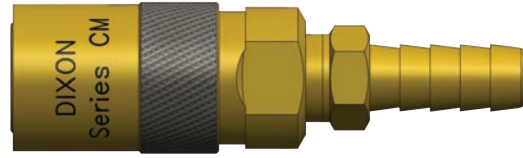
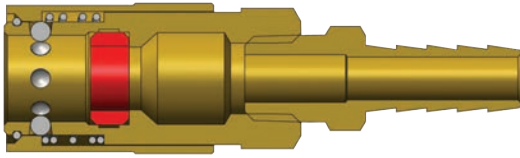

Body Size	CM-Series Industrial Mold Interchange Unvalved Coupler (Hose Barb)							
	Part Detail			Length		Maximum O.D.		Hex inch
	Part #	Hose I.D.	Material	inch	mm	inch	mm	
1/4"	2CMS2-B-E	1/4"	brass	2.11	53.6	0.69	17.5	-
	2CMS2.5-B-E	5/16"	brass	2.10	53.3	0.69	17.5	-
	2CMS3-B-E	3/8"	brass	2.10	53.3	0.69	17.5	-
3/8"	3CMS3-B-E	3/8"	brass	2.55	64.8	0.95	24.1	-
	3CMS4-B-E	1/2"	brass	2.55	64.8	0.95	24.1	-
1/2"	4CMS4-B-E	1/2"	brass	2.98	75.7	1.18	30.0	-
	4CMS6-B-E	3/4"	brass	2.98	75.7	1.18	30.0	-

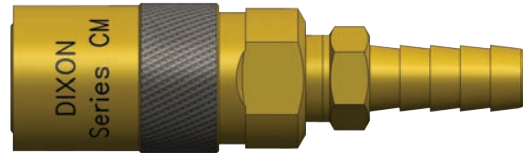
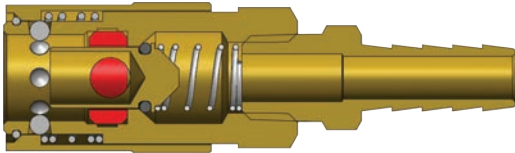

Body Size	CM-Series Industrial Mold Interchange Valved Coupler (Hose Barb)							
	Part Detail			Length		Maximum O.D.		Hex inch
	Part #	Hose I.D.	Material	inch	mm	inch	mm	
1/4"	2CMS2-B	1/4"	brass	2.66	67.6	0.69	17.5	-
	2CMS2.5-B	5/16"	brass	2.66	67.6	0.69	17.5	-
	2CMS3-B	3/8"	brass	2.66	67.6	0.69	17.5	-
3/8"	3CMS3-B	3/8"	brass	3.30	83.8	0.95	24.1	-
	3CMS4-B	1/2"	brass	3.28	83.3	0.95	24.1	-

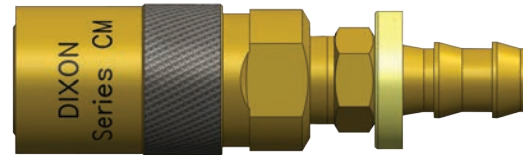
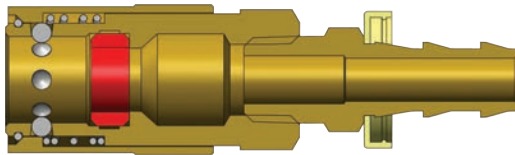

Body Size	CM-Series Industrial Mold Interchange Unvalved Coupler (Push-Loc Barb)							
	Part Detail			Length		Maximum O.D.		Hex inch
	Part #	Hose I.D.	Material	inch	mm	inch	mm	
1/4"	2CMB2-B-E	1/4"	brass	2.08	52.8	0.69	17.5	-
	2CMB3-B-E	3/8"	brass	2.08	52.8	0.69	17.5	-
3/8"	3CMB3-B-E	3/8"	brass	2.53	64.3	0.95	24.1	-
	3CMB4-B-E	1/2"	brass	2.69	68.3	0.95	24.1	-
1/2"	4CMB4-B-E	1/2"	brass	3.12	79.2	1.18	30.0	-
	4CMB6-B-E	3/4"	brass	3.12	79.2	1.18	30.0	-

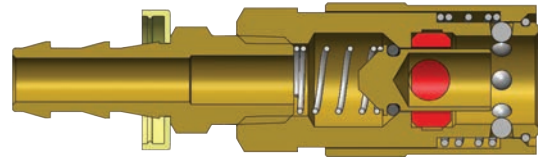
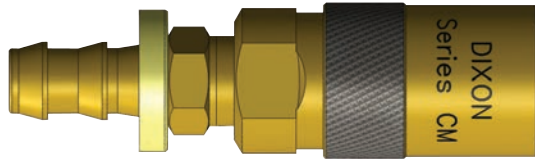

Body Size	CM-Series Industrial Mold Interchange Valved Coupler (Push-Loc Barb)							
	Part Detail			Length		Maximum O.D.		Hex inch
	Part #	Hose I.D.	Material	inch	mm	inch	mm	
1/4"	2CMB2-B	1/4"	brass	2.64	67.1	0.69	17.5	-
	2CMB3-B	3/8"	brass	2.67	67.8	0.69	17.5	-
3/8"	3CMB3-B	3/8"	brass	3.28	83.3	0.95	24.1	-
	3CMB4-B	1/2"	brass	3.44	87.4	0.95	24.1	-

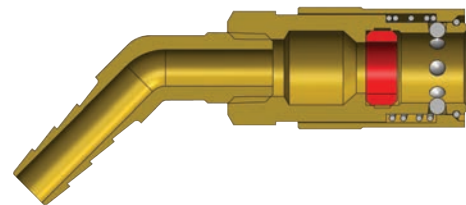
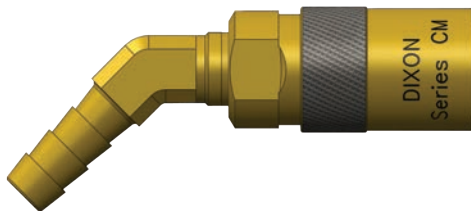

Body Size	CM-Series Industrial Mold Interchange Unvalved Coupler (45° Hose Barb)							
	Part Detail			Length		Maximum O.D.		Hex inch
	Part #	Hose I.D.	Material	inch	mm	inch	mm	
1/4"	2CM4S2-B-E	1/4"	brass	2.87	72.9	0.69	17.5	-
	2CM4S2.5-B-E	5/16"	brass	2.89	73.4	0.69	17.5	-
	2CM4S3-B-E	3/8"	brass	2.91	73.9	0.69	17.5	-
3/8"	3CM4S3-B-E	3/8"	brass	3.83	97.3	0.95	24.1	-
	3CM4S4-B-E	1/2"	brass	3.86	98.0	0.95	24.1	-
1/2"	4CM4S4-B-E	1/2"	brass	4.18	106.2	1.18	30.0	-
	4CM4S6-B-E	3/4"	brass	4.56	115.8	1.18	30.0	-

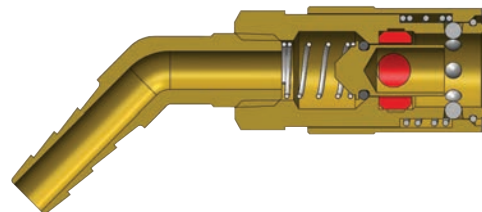
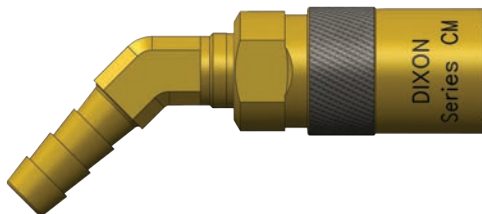

Body Size	CM-Series Industrial Mold Interchange Valved Coupler (45° Hose Barb)							
	Part Detail			Length		Maximum O.D.		Hex inch
	Part #	Hose I.D.	Material	inch	mm	inch	mm	
1/4"	2CM4S2-B	1/4"	brass	2.87	72.9	0.69	17.5	-
	2CM4S2.5-B	5/16"	brass	2.89	73.4	0.69	17.5	-
	2CM4S3-B	3/8"	brass	2.91	73.9	0.69	17.5	-
3/8"	3CM4S3-B	3/8"	brass	3.83	97.3	0.95	24.1	-
	3CM4S4-B	1/2"	brass	3.86	98.0	0.95	24.1	-

Hydraulic Couplings: CM-Series

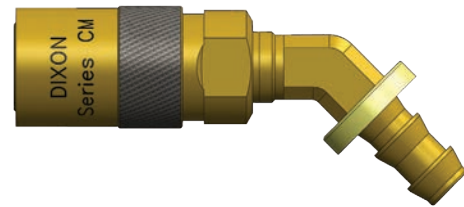
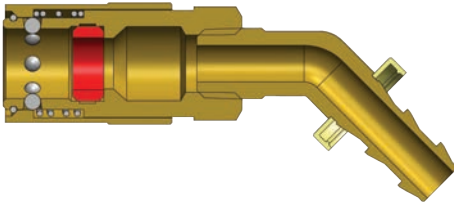

CM-Series Industrial Mold Interchange Unvalved Coupler (45° Push-Loc Barb)

Body Size	CM-Series Industrial Mold Interchange Unvalved Coupler (45° Push-Loc Barb)							
	Part Detail			Length		Maximum O.D.		Hex inch
	Part #	Hose I.D.	Material	inch	mm	inch	mm	
1/4"	2CM4B2-B-E	1/4"	brass	2.86	72.6	0.69	17.5	-
	2CM4B3-B-E	3/8"	brass	2.92	74.2	0.69	17.5	-
3/8"	3CM4B3-B-E	3/8"	brass	3.82	97.0	0.95	24.1	-
	3CM4B4-B-E	1/2"	brass	3.98	101.1	0.95	24.1	-
1/2"	4CM4B4-B-E	1/2"	brass	4.28	108.7	1.18	30.0	-
	4CM4B6-B-E	3/4"	brass	4.56	115.8	1.18	30.0	-

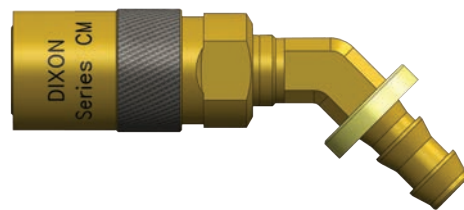
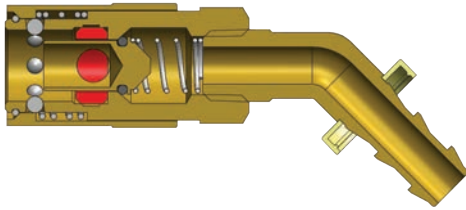

CM-Series Industrial Mold Interchange Valved Coupler (45° Push-Loc Barb)

Body Size	CM-Series Industrial Mold Interchange Valved Coupler (45° Push-Loc Barb)							
	Part Detail			Length		Maximum O.D.		Hex inch
	Part #	Hose I.D.	Material	inch	mm	inch	mm	
1/4"	2CM4B2-B	1/4"	brass	2.86	72.6	0.69	17.5	-
	2CM4B3-B	3/8"	brass	2.92	74.2	0.69	17.5	-
3/8"	3CM4B3-B	3/8"	brass	3.82	97.0	0.95	24.1	-
	3CM4B4-B	1/2"	brass	3.98	101.1	0.95	24.1	-

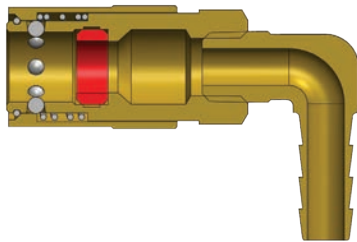

CM-Series Industrial Mold Interchange Unvalved Coupler (90° Hose Barb)

Body Size	CM-Series Industrial Mold Interchange Unvalved Coupler (90° Hose Barb)							
	Part Detail			Length		Maximum O.D.		Hex inch
	Part #	Hose I.D.	Material	inch	mm	inch	mm	
1/4"	2CM9S2-B-E	1/4"	brass	1.98	50.3	0.69	17.5	-
	2CM9S2.5-B-E	5/16"	brass	1.98	50.3	0.69	17.5	-
	2CM9S3-B-E	3/8"	brass	2.17	55.1	0.69	17.5	-
3/8"	3CM9S3-B-E	3/8"	brass	2.84	72.1	0.95	24.1	-
	3CM9S4-B-E	1/2"	brass	2.85	72.4	0.95	24.1	-
1/2"	4CM9S4-B-E	1/2"	brass	3.50	88.9	1.18	30.0	-
	4CM9S6-B-E	3/4"	brass	3.50	88.9	1.18	30.0	-

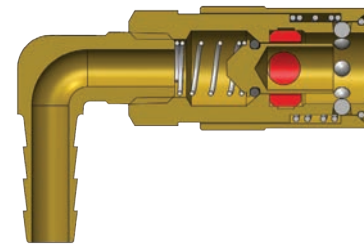

Body Size	CM-Series Industrial Mold Interchange Valved Coupler (90° Hose Barb)							
	Part Detail			Length		Maximum O.D.		Hex inch
	Part #	Hose I.D.	Material	inch	mm	inch	mm	
1/4"	2CM9S2-B	1/4"	brass	1.98	50.3	0.69	17.5	-
	2CM9S2.5-B	5/16"	brass	1.98	50.3	0.69	17.5	-
	2CM9S3-B	3/8"	brass	2.17	55.1	0.69	17.5	-
3/8"	3CM9S3-B	3/8"	brass	2.84	72.1	0.95	24.1	-
	3CM9S4-B	1/2"	brass	2.85	72.4	0.95	24.1	-

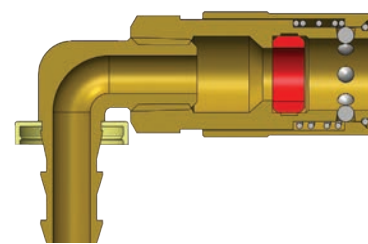
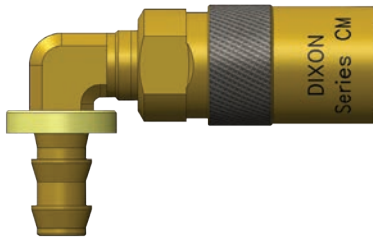

Body Size	CM-Series Industrial Mold Interchange Unvalved Coupler (90° Push-Loc Barb)							
	Part Detail			Length		Maximum O.D.		Hex inch
	Part #	Hose I.D.	Material	inch	mm	inch	mm	
1/4"	2CM9B2-B-E	1/4"	brass	2.07	52.6	0.69	17.5	-
	2CM9B3-B-E	3/8"	brass	2.17	55.1	0.69	17.5	-
3/8"	3CM9B3-B-E	3/8"	brass	2.93	74.4	0.95	24.1	-
	3CM9B4-B-E	1/2"	brass	2.98	75.7	0.95	24.1	-
1/2"	4CM9B4-B-E	1/2"	brass	3.50	88.9	1.18	30.0	-
	4CM9B6-B-E	3/4"	brass	3.50	88.9	1.18	30.0	-

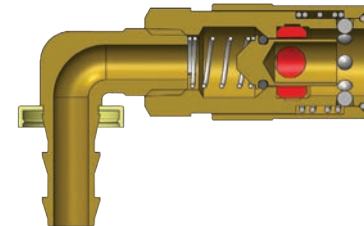
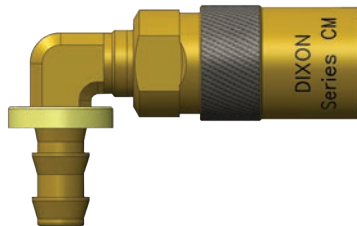

Body Size	CM-Series Industrial Mold Interchange Valved Coupler (90° Push-Loc Barb)							
	Part Detail			Length		Maximum O.D.		Hex inch
	Part #	Hose I.D.	Material	inch	mm	inch	mm	
1/4"	2CM9B2-B	1/4"	brass	2.07	52.6	0.69	17.5	-
	2CM9B3-B	3/8"	brass	2.17	55.1	0.69	17.5	-
3/8"	3CM9B3-B	3/8"	brass	2.93	74.4	0.95	24.1	-
	3CM9B4-B	1/2"	brass	2.98	75.7	0.95	24.1	-

Hydraulic Couplings: CM-Series

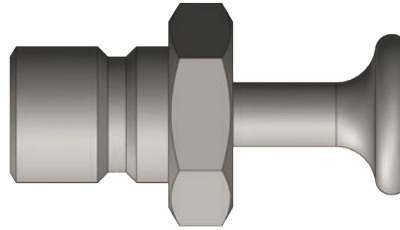

Body Size	CM-Series Coupler Rigid Dust Plug		
	Part Detail		
	Part #	Lanyard	Body
1/4"	2CMPC-B	N/A	brass
3/8"	3CMPC-B	N/A	brass
1/2"	4CMPC-B	N/A	brass

Body Size	CM-Series Industrial Mold Interchange Coupler Seal Kits			
	Part Detail			Seal Kit Contents
	Part #	Coupler Style	Seal Material	
1/4"	2CM-SKIT	all	Silicone	body seal
3/8"	3CM-SKIT	all	Silicone	body seal
1/2"	4CM-SKIT	all	Silicone	body seal

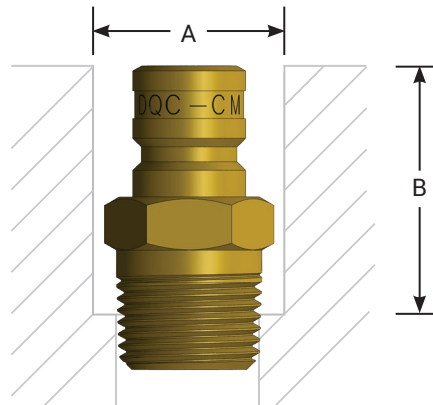

Counterbored mold ports will protect the male threaded plug, allowing the plug to be mounted below the surface, simplifying storing and handling of molds. Dixon male threaded plugs are constructed of corrosion resistant brass to maximize longevity in moist environments.

Body Size	Part Detail		Dimension A	Dimension B
	Part #	Threads		
1/4"	CM2M1-B	1/8" - 27 NPTF	17.5 mm (0.69")	17.5 mm (0.69")
	CM2M2-B	1/4" - 18 NPTF	21.3 mm (0.84")	23.9 mm (0.94")
	CM2M3-B	3/8" - 18 NPTF	25.4 mm (1.00")	24.6 mm (0.97")
3/8"	CM3M2-B	1/4" - 18 NPTF	17.5 mm (0.69")	23.9 mm (0.94")
	CM3M3-B	3/8" - 18 NPTF	21.3 mm (0.84")	28.7 mm (1.13")
	CM3M4-B	1/2" - 14 NPTF	25.4 mm (1.00")	31.8 mm (1.25")
1/2"	CM4M4-B	1/2" - 14 NPTF	31.8 mm (1.25")	38.1 mm (1.50")
	CM4M6-B	3/4" - 14 NPTF	38.1 mm (1.50")	39.6 mm (1.56")

Application

- Designed specifically for blowout prevention systems on drilling rigs

Features

- Fire tested and Lloyd's certified to **1300°F (700°C)** in accordance with API 16D, certificate available upon request
- Certified at a test pressure of **5,000 PSI**
- Red powder-coated components and external seals provide easy BOP-approved identification
- Critical seals are FKM

Product Offering

- VEP-BOP-Series: (pg. 145)
 - Thread-to-connect flushface interchange
 - 3/8" to 1-1/2" in steel
- H-BOP-Series: (pg. 80)
 - ISO-B interchange
 - 3/8" to 1" in steel and 316 stainless
- WS-BOP-Series: (pg. 158)
 - Same reliable wing coupling you know, with red components
 - 3/4" to 2" in steel and 316 stainless steel



Part #	Page #	Part #	Page #	Part #	Page #	Part #	Page #
1AF1-B	65	2CM9S2.5-B-E	182	2FBF1-B	21	2JB2-B	34
1AM1-B	66	2CM9S2-B	183	2FBF2-B	21	2JB3-B	34
1AS1-B	66	2CM9S2-B-E	182	2FBF3-B	21	2JF1-B	31
1BRBF1-B-7	63	2CM9S3-B	183	2FBM1-B	24	2JF2-B	31
1BRBF2-B-7	63	2CM9S3-B-E	182	2FBM2-B	24	2JF3-B	31
1BRF1-B-7	63	2CMB2-B	181	2FBM3-B	24	2JM1-B	32
1BRF2-B-7	63	2CMB2-B-E	180	2FF1-B	21	2JM2-B	32
1BRGM1-B-7	64	2CMB3-B	181	2FF2	21	2JM3-B	32
1BRGM2-B-7	64	2CMB3-B-E	180	2FF2-B	21	2JS2-B	33
1BRM1-B-7	64	2CMF1-B	179	2FF2-S	21	2JS3-B	33
1BRM2-B-7	64	2CMF1-B-E	179	2FF3-B	21	2KBF2	88
1BRS1.25-B-7	64	2CMF2-B-E	179	2FF3-S	21	2KBF2-SS	88
1BRS1.86-B-7	64	2CMPC-B	184	2FM1-B	24	2KDP	91
1BRS2.83-B-7	64	2CMS2.5-B	180	2FM1-S	24	2KF1	88
1EF1-B	170	2CMS2.5-B-E	180	2FM2	24	2KF2	88
1EF1-S	170	2CMS2-B	180	2FM2-B	24	2KF2-SS	88
1EM1-B	172	2CMS2-B-E	180	2FM2-S	24	2KOF2	88
1EM1-S	172	2CMS3-B	180	2FM3-B	24	2K-SKIT	92
1HDP	77, 111	2CMS3-B-E	180	2FM3-S	24	2LF2-B	45
1HF1	71	2CM-SKIT	184	2FS2	26	2LM2-B	46
1HF1-B	71	2CVVBF2	164	2FS2.5-B	26	2MF2-B	36
1HF1-S	71	2CVVDP	166	2FS2-B	26	2MF3-B	36
1HF1-SS	71	2CVVF2	164	2FS2-S	26	2MM2-B	37
1HOF2	71	2CVVFM1415	164	2FS3-B	26	2MM2-PL	36
1H-SKIT	78	2DB2-B	27	2FS3-S	26	2MM3-B	37
1PDF1	138	2DB3-B	27	2HBF2	71	2MM3-PL	36
1PDF2	138	2DBF2-B	21	2HBF2-B	71	2MS2.5-PL	37
1PDM2	139	2DBF3-B	21	2HBF2-S	71	2MS2-B	38
2AE2-B	67	2DBM2-B	23	2HBF2-SS	71	2MS2-PL	37
2AF1-B	65	2DBM3-B	23	2H-BRKIT	79	2MS3-B	38
2AF2-B	65	2DE2-B	28	2HDP	77	2MS3-PL	37
2AGDP	96	2DF1-B	21	2HDP-A	77	2NKBF2	61
2AGF2	94	2DF2-B	21	2HF2	71	2NKBM2	62
2AGF2-PV	94	2DF2-S	21	2HF2-B	71	2NKF2	61
2AM1-B	66	2DF3-B	21	2HF2-S	71	2NKM2	62
2AM2-B	66	2DF3-S	21	2HF2-SS	71	2NKS2	62
2AS2-B	66	2DH2-B	28	2HOF3	71	2SHDM2	43
2CJBM2-B	40	2DK3-B	28	2H-RKIT	79	2SHDM3	43
2CJBM3-B	40	2DL3-B	28	2HSBF2-B	83	2SHDS2	44
2CJM2-B	40	2DM1-B	23	2HSBF2-S	83	2SHDS3	44
2CJM3-B	40	2DM2-B	23	2HSF2-B	83	2STBF2	133
2CM4B2-B	182	2DM2-S	23	2HSF2-S	83	2STBF2-SS	133
2CM4B2-B-E	182	2DM3-B	23	2H-SKIT	78	2ST-BMK	137
2CM4B3-B	182	2DM3-S	23	2H-SRKIT	79	2STDP-A	136
2CM4B3-B-E	182	2DS2-B	26	2H-SSRKIT	79	2STF2	133
2CM4S2.5-B	181	2DS2-S	26	2HTBAND-B	118	2STF2-SS	133
2CM4S2.5-B-E	181	2DS3-B	26	2HTBAND-G	118	2ST-SKIT	137
2CM4S2-B	181	2DS3-S	26	2HTBAND-O	118	2TDP	162
2CM4S2-B-E	181	2EBF2-B	170	2HTBAND-R	118	2TF2	161
2CM4S3-B	181	2EF2-B	170	2HTBAND-Y	118	2TM2	161
2CM4S3-B-E	181	2EF2-S	170	2HTBF2	119	2T-SKIT	162
2CM9B2-B	183	2EM2-B	172	2HTDP	124	2UB2-B	48
2CM9B2-B-E	183	2EM2-S	172	2HTF2	119	2UB3-B	48
2CM9B3-B	183	2ES2-B	173	2HTF2-FS	123	2UBF2-B	48
2CM9B3-B-E	183	2E-SKIT	174	2HTOF3	119	2UBF3-B	48
2CM9S2.5-B	183	2FB2-B	28	2HT-SKIT	124	2UBM2-B	48
		2FB3-B	28			2UBM3-B	48

Part #	Page #	Part #	Page #	Part #	Page #	Part #	Page #
2UF2-B	48	3CM4S4-B	181	3FF3-S	21	3JB4	34
2UF3-B	48	3CM4S4-B-E	181	3FF4	21	3JF2	31
2UM2-B	48	3CM9B3-B	183	3FM2	24	3JF3	31
2UM3-B	48	3CM9B3-B-E	183	3FM3	24	3JF4	31
2US2-B	48	3CM9B4-B	183	3FM3-S	24	3JM2	32
2US3-B	48	3CM9B4-B-E	183	3FM4	24	3JM3	32
2VBF2	101	3CM9S3-B	183	3FS2	26	3JM4	32
2VBF2-B-E	108	3CM9S3-B-E	182	3FS3	26	3JS2	33
2VBF2-E	108	3CM9S4-B	183	3FS3-S	26	3JS3	33
2VBF2-SS	101	3CM9S4-B-E	182	3FS4	26	3JS4	33
2VBF2-SS-E	108	3CMB3-B	181	3HBF3	71	3KBF3	88
2V-BRKIT	114	3CMB3-B-E	180	3HBF3-B	71	3KBF3-SS	88
2VDP-A	112	3CMB4-B	181	3HBF3-S	71	3KDP	91, 111
2VEPBF2	141	3CMB4-B-E	180	3HBF3-SS	71	3KF3	88
2VEPDP-A	144	3CMF2-B	179	3H-BRKIT	79	3KF3-SS	88
2VEPF2	141	3CMF2-B-E	179	3HDP	77	3KOF3	88
2VEPOF3	141	3CMF3-B-E	179	3HDP-A	77	3K-SKIT	92
2VF1	101	3CMPC-B	184	3HF3	71	3MM3-PL	36
2VF2	101	3CMS3-B	180	3HF3-B	71	3MM4-PL	36
2VF2-B	101	3CMS3-B-E	180	3HF3-BOP	81	3MS3-PL	37
2VF2-B-E	108	3CMS4-B	180	3HF3-S	71	3NBM4	52
2VF2-E	108	3CMS4-B-E	180	3HF3-SS	71	3NCS4	54
2VF2-SS	101	3CM-SKIT	184	3HF3-SS-BOP	81	3NM4	52
2VF2-SS-E	108	3CVBF3	164	3HOF4	71	3N-SKIT	56
2VJM2	107	3CVVDP	166	3H-RKIT	79	3STBF3	133
2VM1	105	3CVVF3	164	3HSBF3-B	83	3STBF3-SS	133
2VM2	105	3CVVFM1615	164	3HSBF3-S	83	3STBF4	133
2VM2-B	105	3DB3-B	27	3HSF3-B	83	3STBF4-SS	133
2VM2-B-E	110	3DBF3-B	21	3HSF3-S	83	3ST-BMK	137
2VM2-E	110	3DBM3-B	23	3H-SKIT	78	3STDPA	136
2VM2-SS	105	3DF2-B	21	3H-SRKIT	79	3STF2	133
2VM2-SS-E	110	3DF3-B	21	3H-SSRKIT	79	3STF3	133
2VOF2	101	3DF3-S	21	3HTBAND-B	118	3STF3-SS	133
2V-RKIT	114	3DF4-B	21	3HTBAND-G	118	3STF4	133
2V-SKIT	113	3DM2-B	23	3HTBAND-O	118	3STF4-SS	133
2V-SSRKIT	114	3DM3-B	23	3HTBAND-R	118	3ST-SKIT	137
2WDP	151	3DM3-S	23	3HTBAND-Y	118	3TDP	162
2WF1-B	149	3DM4-B	23	3HTBF3	119	3TF3	161
2WF1-B-HN	149	3DS2-B	26	3HTBF3-SS	119	3TM3	161
2XKF2	131	3DS3-B	26	3HTBF4	119	3TM3-PV	161
2XKM2	131	3DS3-S	26	3HTBF4-SS	119	3TM3-SS	161
3AGDP	96	3DS4-B	26	3HTDP	124	3TM3-SS-PV	161
3AGF3	94	3EBF3-B	170	3HTF3	119	3TRBF3	116
3AGF3-PS	95	3EF3-B	170	3HTF3-FS	123	3TRF3	116
3AGF3-PV	94	3EF3-S	170	3HTF3-SS	119	3TR-SKIT	116
3AGF3-PV-PS	95	3EM3-B	172	3HTF4	119	3T-SKIT	162
3CJBM3-B	40	3EM3-S	172	3HTF4-SS	119	3UBF3-B	48
3CJBM4-B	40	3ES3-B	173	3HTM3	121	3UBM3-B	48
3CJM3-B	40	3E-SKIT	174	3HTM4	121	3UF3-B	48
3CJM4-B	40	3FB2	28	3HTOF3	119	3UM3-B	48
3CM4B3-B	182	3FB3	28	3HTOF4	119	3US3-B	48
3CM4B3-B-E	182	3FB4	28	3HTOM3	121	3VBF3	101
3CM4B4-B	182	3FBF3	21	3HTOM4	121	3VBF3-B	101
3CM4B4-B-E	182	3FBM3	24	3HT-SKIT	124	3VBF3-B-E	108
3CM4S3-B	181	3FF2	21	3JB2	34	3VBF3-E	108
3CM4S3-B-E	181	3FF3	21	3JB3	34	3VBF3-SS	101

Part #	Page #	Part #	Page #	Part #	Page #	Part #	Page #
3VBF3-SS-E.....	108	4AGOF5-PS.....	95	4FF4-S.....	21	4HTOF6.....	119
3VBRKIT.....	114	4AGOF5-PV.....	94	4FF6.....	21, 31	4HTRB4.....	122
3VDP.....	111	4AGOF5-PV-PS.....	95	4FM3.....	24, 32	4HTRB5.....	122
3VDP-A.....	112	4CM4B4-B-E.....	182	4FM4.....	24, 32	4HTRB6.....	122
3VEPBF3.....	141	4CM4B6-B-E.....	182	4FM4-S.....	24	4HT-SKIT.....	124
3VEPBF4.....	141	4CM4S4-B-E.....	181	4FM6.....	24, 32	4HTZF4.....	128
3VEPDP-A.....	144	4CM4S6-B-E.....	181	4FS3.....	26, 33	4HTZF6.....	128
3VEPF3.....	141	4CM9B4-B-E.....	183	4FS4.....	26, 33	4HTZOF4.....	128
3VEPF3-BOP.....	146	4CM9B6-B-E.....	183	4FS4-S.....	26	4HTZOF5.....	128
3VEPF4.....	141	4CM9S4-B-E.....	182	4FS6.....	26, 33	4HTZOF6.....	128
3VEPF4-BOP.....	146	4CM9S6-B-E.....	182	4HBF4.....	71	4JDAG4.....	97
3VEPOF4.....	141	4CMB4-B-E.....	180	4HBF4-B.....	71	4K-B-DP.....	91
3VF3.....	101	4CMB6-B-E.....	180	4HBF4-S.....	71	4KBF4.....	88
3VF3-B.....	101	4CMF4-B-E.....	179	4HBF4-SS.....	71	4KBF4-SS.....	88
3VF3-B-E.....	108	4CMPC-B.....	184	4H-BRKIT.....	79	4KDP.....	91
3VF3-E.....	108	4CMS4-B-E.....	180	4HDP.....	77	4KF4.....	88
3VF3-SS.....	101	4CMS6-B-E.....	180	4HDP-A.....	77	4KF4-SS.....	88
3VF3-SS-E.....	108	4CM-SKIT.....	184	4HF4.....	71	4KF6.....	88
3VF4.....	101	4CVVBF4.....	164	4HF4-B.....	71	4K-G-DP.....	91
3VJM3.....	107	4CVVDP.....	166	4HF4-BOP.....	81	4K-O-DP.....	91
3VM3.....	105	4CVVF4.....	164	4HF4-HV.....	75	4KOF4.....	88
3VM3-B.....	105	4CVVFM1815.....	164	4HF4-S.....	71	4KOF5.....	88
3VM3-B-E.....	110	4CVVFM2215.....	164	4HF4-SS.....	71	4K-R-DP.....	91
3VM3-E.....	110	4CVVOF4.....	164	4HF4-SS-BOP.....	81	4K-SKIT.....	92
3VM3-SS.....	105	4CVVOF5.....	164	4HOF5.....	71	4K-Y-DP.....	91
3VM3-SS-E.....	110	4DB4-B.....	27	4H-RKIT.....	79	4N4N.....	56
3VOF3.....	101	4DBF4-B.....	21	4HSBF4-B.....	83	4NBF3.....	50
3V-RKIT.....	114	4DBM4-B.....	23	4HSBF4-S.....	83	4NBF4.....	50
3V-SKIT.....	113	4DF3-B.....	21	4HSF4-B.....	83	4NBF4-B.....	50
3V-SSRKIT.....	114	4DF4-B.....	21	4HSF4-S.....	83	4NBF6.....	50
3WDP.....	151	4DF4-S.....	21	4H-SKIT.....	78	4NBF6-B.....	50
3WF2-B.....	149	4DF6-B.....	21	4H-SRKIT.....	79	4NBF8.....	50
3WF2-B-HN.....	149	4DM3-B.....	23	4H-SSRKIT.....	79	4NBF8-B.....	50
3WF3-B.....	149	4DM4-B.....	23	4HT90F3.....	123	4NBM3.....	52
3WF3-B-HN.....	149	4DM4-S.....	23	4HT90F4.....	123	4NBM4.....	52
3XKF3.....	131	4DM6-B.....	23	4HTAG4.....	129	4NBM4-B.....	52
3XKM3.....	131	4DS3-B.....	26	4HTBAND-B.....	118	4NBM6.....	52
4.5TDDP-A.....	168	4DS4-B.....	26	4HTBAND-G.....	118	4NBM6-B.....	52
4AGBF4.....	94	4DS4-S.....	26	4HTBAND-O.....	118	4NBM8.....	52
4AGBF4-PV.....	94	4DS6-B.....	26	4HTBAND-R.....	118	4NBM8-B.....	52
4AGF4.....	94	4EAF3.....	176	4HTBAND-Y.....	118	4NF3.....	50
4AGF4-PS.....	95	4EAF4.....	176	4HTBF4.....	119	4NF3-B.....	50
4AGF4-PV.....	94	4EA-SKIT.....	176	4HTBF4-SS.....	119	4NF4.....	50
4AGF4-PV-PS.....	95	4EBF4-B.....	170	4HTBF6.....	119	4NF4-B.....	50
4AGF6.....	94	4EF4-B.....	170	4HTBF6-SS.....	119	4NF6.....	50
4AGF6-PS.....	95	4EF4-S.....	170	4HTDP.....	124	4NF6-B.....	50
4AGF6-PV.....	94	4EM4-B.....	172	4HTF4.....	119	4NF6-S.....	50
4AGF6-PV-PS.....	95	4EM4-S.....	172	4HTF4-FS.....	123	4NF6-SS.....	50
4AGHT4.....	129	4ES4-B.....	173	4HTF4-SS.....	119	4NF8.....	50
4AGIH4.....	97	4E-SKIT.....	174	4HTF6.....	119	4NF8-B.....	50
4AGJD4.....	97	4FB3.....	28, 34	4HTF6-SS.....	119	4NF8-SS.....	50
4AGOF4.....	94	4FB4.....	28, 34	4HTJB5.....	122	4NM3.....	52
4AGOF4-PS.....	95	4FBF4.....	21	4HTJB6.....	122	4NM3-B.....	52
4AGOF4-PV.....	94	4FBM4.....	24	4HTM4.....	121	4NM4.....	52
4AGOF4-PV-PS.....	95	4FF3.....	21, 31	4HTOF4.....	119	4NM4-B.....	52
4AGOF5.....	94	4FF4.....	21, 31	4HTOF5.....	119	4NM6.....	52

Part #	Page #	Part #	Page #	Part #	Page #	Part #	Page #
4NM6-B	52	4ST-BMK	137	5HTF6-SS	119	6HTBAND-Y	118
4NM6-S	52	4STDP-A	136	5HTOF5	119	6HTBF6	119
4NM6-SS	52	4STF4	133	5HTOF6	119	6HTBF6-SS	119
4NM8	52	4STF4-SS	133	5HT-SKIT	124	6HTBF8	119
4NM8-B	52	4STOF4	133	6AGDP	96	6HTBF8-SS	119
4NM8-SS	52	4ST-SKIT	137	6AGF6	94	6HTDP	124
4NS3	54	4TDDP-A	168	6AGF6-PS	95	6HTF6	119
4NS3-B	54	4TDF4-SS	168	6AGF6-PV	94	6HTF6-FS	123
4NS4	54	4TDPF4.5-SS	168	6AGF6-PV-PS	95	6HTF6-SS	119
4NS4-B	54	4TRBF4	116	6BOP-SKIT	157	6HTF8	119
4NS4-B-WF	56	4TRF4	116	6CVVBF6	164	6HTF8-SS	119
4NS4-WF	56	4TR-SKIT	116	6CVVDP	166	6HTOF5	119
4NS6	54	4VBF4	101	6CVVF6	164	6HTOF6	119
4NS6-B	54	4VBF4-B	101	6CVVFM2215	164	6HTOF8	119
4NS6-B-WF	56	4VBF4-B-E	108	6DF4-B	21	6HT-SKIT	124
4NS6-S	54	4VBF4-E	108	6DF6-B	21	6KBF6	89
4NS6-SS	54	4VBF4-SS	101	6DF8-B	21	6KBF6-SS	89
4NS6-WF	56	4VBF4-SS-E	108	6DM4-B	23	6KDP	91
4NS8	54	4V-BRKIT	114	6DM6-B	23	6KF6	89
4NS8-B	54	4VDP-A	112	6DM8-B	23	6KF6-SS	89
4NS8-S	54	4VEPBF4	141	6DS4-B	26	6KOF6	89
4NS8-SS	54	4VEPBF6	141	6DS6-B	26	6K-SKIT	92
4N-SKIT	56	4VEPDP-A	144	6DS8-B	26	6STBF6	133
4P-CLIP	57	4VEPF4	141	6EBF6-B	170	6STBF6-SS	133
4PDC-A	59	4VEPF4-BOP	146	6EF6-B	170	6ST-BMK	137
4PF4	58	4VEPF6	141	6EF6-S	170	6STDP-A	136
4PF6	58	4VEPOF4	141	6EM6-B	172	6STF6	133
4PF6-B	58	4VEPOF5	141	6EM6-S	172	6STF6-SS	133
4PF6-S	58	4VEPOF6	141	6ES6-B	173	6STOF6	133
4PM3	59	4VF4	101	6E-SKIT	174	6ST-SKIT	137
4PM4	59	4VF4-B	101	6HBF6	71	6TRBF6	116
4PM6	59	4VF4-B-E	108	6HBF6-B	71	6TRF6	116
4PM6-9	59	4VF4-E	108	6HBF6-S	71	6TR-SKIT	116
4PM6-S	59	4VF4-SS	101	6HBF6-SS	71	6VBF6	101
4PM8	59	4VF4-SS-E	108	6H-BRKIT	79	6VBF6-B	101
4PS3	60	4VF6	101	6HDP	77	6VBF6-B-E	108
4PS4	60	4VJM4	107	6HDP-A	77	6VBF6-E	108
4PS4-B	60	4VM4	105	6HF6	71	6VBF6-SS	101
4PS4-B-WF	60	4VM4-B	105	6HF6-B	71	6VBF6-SS-E	108
4PS4-WF	60	4VM4-B-E	110	6HF6-BOP	81	6V-BRKIT	114
4PS6	60	4VM4-E	110	6HF6-S	71	6VDP	111
4PS6-9	60	4VM4-SS	105	6HF6-SS	71	6VDP-A	112
4PS6-B	60	4VM4-SS-E	110	6HF6-SS-BOP	81	6VEPBF6	141
4PS6-B-WF	60	4VOF4	101	6HOF6	71	6VEPDP-A	144
4PS6-S	60	4V-RKIT	114	6H-RKIT	79	6VEPF6	141
4PS6-S-WF	60	4V-SKIT	113	6HSBF6-B	83	6VEPF6-BOP	146
4PS6-WF	60	4V-SSRKIT	114	6HSBF6-S	83	6VEPFH6	143
4PS8	60	5HTBAND-B	118	6HSF6-B	83	6VEPPF6	143
4PS8-B	60	5HTBAND-G	118	6HSF6-S	83	6VEPOF6	141
4P-SKIT	60	5HTBAND-O	118	6H-SKIT	78	6VF6	101
4SHDM3	43	5HTBAND-R	118	6H-SRKIT	79	6VF6-B	101
4SHDM4	43	5HTBAND-Y	118	6H-SSRKIT	79	6VF6-B-E	108
4SHDS3	44	5HTBF6	119	6HTBAND-B	118	6VF6-E	108
4SHDS4	44	5HTBF6-SS	119	6HTBAND-G	118	6VF6-SS	101
4STBF4	133	5HTDP	124	6HTBAND-O	118	6VF6-SS-E	108
4STBF4-SS	133	5HTF6	119	6HTBAND-R	118	6VJM6	107

Part #	Page #	Part #	Page #	Part #	Page #	Part #	Page #
6VM6.....	105	8HF8	71	8ST-SKIT-V2	137	10BOP-SKIT	157
6VM6-B	105	8HF8-B	71	8TRBF8	116	10CVVBF10	164
6VM6-B-E	110	8HF8-BOP	81	8TRF8	116	10CVVDP	166
6VM6-E	110	8HF8-S	71	8TR-SKIT	116	10CVVF10	164
6VM6-SS	105	8HF8-SS	71	8VBF8	101	10EF10-B	170
6VM6-SS-E	110	8HF8-SS-BOP	81	8VBF8-B	101	10EF10-S	170
6VOF6	101	8HOF8	71	8VBF8-B-E	108	10EM10-B	172
6V-RKIT	114	8H-RKIT	79	8VBF8-E	108	10E-SKIT	174
6V-SKIT	113	8HSBF8-B	83	8VBF8-SS	101	10HBF10	73
6V-SSRKIT	114	8HSBF8-S	83	8VBF8-SS-E	108	10HBF10-B	73
6WBF4-B	149	8HSF8-B	83	8V-BRKIT	114	10HBF10-S	73
6WBF4-B-HN	149	8HSF8-S	83	8VDP	111	10HBF10-SS	73
6WBF6-B	149	8H-SKIT	78	8VDP-A	112	10H-BRKIT	79
6WBF6-B-HN	149	8H-SRKIT	79	8VEPBF8	141	10HF10	73
6WDP	151	8H-SSRKIT	79	8VEPDP-A	144	10HF10-B	73
6WF4-B	149	8HTBAND-B	118	8VEPF8	141	10HF10-S	73
6WF4-B-HN	149	8HTBAND-G	118	8VEPF8-BOP	146	10HF10-SS	73
6WF6-B	149	8HTBAND-O	118	8VEPFH8	143	10H-RKIT	79
6WF6-B-HN	149	8HTBAND-R	118	8VEFPF8	143	10H-SKIT	78
6W-RKIT-V2	151	8HTBAND-Y	118	8VEPOF8	141	10H-SRKIT	79
6WSBF6	153	8HTBF8	119	8VF8	101	10H-SSRKIT	79
6WSBF6-SS	153	8HTBF8-SS	119	8VF8-B	101	10KBF10	89
6WSDP-A	156	8HTBF10	119	8VF8-B-E	108	10KDP-A	92
6WSF4	153	8HTBF10-SS	119	8VF8-E	108	10KF10	89
6WSF4-BOP	159	8HTDP	124	8VF8-SS	101	10K-SKIT	92
6WSF6	153	8HTF8	119	8VF8-SS-E	108	10VBF10	103
6WSF6-BOP	159	8HTF8-FS	123	8VJM8	107	10VBF10-B	103
6WSF6-SS	153	8HTF8-SS	119	8VM8	105	10VBF10-B-E	108
6WSF6-SS-BOP	159	8HTF10	119	8VM8-B	105	10VBF10-E	108
6WSFH6	155	8HTF10-SS	119	8VM8-B-E	110	10VBF10-SS	103
6WSFP6	155	8HTOF8	119	8VM8-E	110	10VBF10-SS-E	108
6WSOF6	153	8HTOF10	119	8VM8-SS	105	10VDP-A	112
6WS-RKIT	157	8HT-SKIT	124	8VM8-SS-E	110	10VEPBF10	141
6WS-SKIT	157	8KBF8	89	8VOF8	101	10VEPDP-A	144
8AGDP	96	8KBF8-SS	89	8V-RKIT	114	10VEPF10	141
8AGF8	94	8KDP	91	8V-SKIT	113	10VEPF10-BOP	146
8AGF8-PV	94	8KF8	89	8V-SSRKIT	114	10VEPFH10	143
8BOP-SKIT	157	8KF8-SS	89	8WBF8-B	149	10VEFPF10	143
8CNGF8-S	86	8KOF8	89	8WBF8-B-HN	149	10VEPOF10	141
8CVVBF8	164	8K-SKIT	92	8WDP	151	10VF10	103
8CVVDP	166	8STBF8	133	8WF8	149	10VF10-B	103
8CVVF8	164	8STBF8-SS	133	8WF8-B	149	10VF10-B-E	108
8EBF8-B	170	8STBF8-V2	134	8WF8-B-HN	149	10VF10-E	108
8EF8-B	170	8STBF10	133	8WF8-HN	149	10VF10-SS	103
8EF8-S	170	8STBF10-SS	133	8W-RKIT-V2	151	10VF10-SS-E	108
8EM8-B	172	8STDP-A	136	8WSBF8	153	10VJM10	107
8EM8-S	172	8STDP-A-V2	136	8WSBF8-SS	153	10VM10	105
8ES8-B	173	8STF8	133	8WSDP-A	156	10VM10-B	105
8E-SKIT	174	8STF8-SS	133	8WSF8	153	10VM10-E	110
8HBF8	71	8STF8-V2	134	8WSF8-BOP	159	10VM10-SS	105
8HBF8-B	71	8STF10	133	8WSF8-SS	153	10VM10-SS-E	110
8HBF8-S	71	8STF10-SS	133	8WSFH8	155	10VOF10	103
8HBF8-SS	71	8STF10-V2	134	8WSFP8	155	10V-SKIT	113
8H-BRKIT	79	8STOF8	133	8WSOF8	153	10WBF10-B	149
8HDP	77	8STOF10	133	8WS-RKIT	157	10WBF10-B-HN	149
8HDP-A	77	8ST-SKIT	137	8WS-SKIT	157	10WDP	151

Part #	Page #	Part #	Page #	Part #	Page #	Part #	Page #
10WF10-B	149	12VEPOF12	141	16VDP-A	112	AG4BF4	95
10WF10-B-HN	149	12VF12	103	16VEPBF16	141	AG4BF4-PV	96
10W-RKIT-V2	151	12VF12-B	103	16VEPDP-A	144	AG4F4	95
10WSBF10	153	12VF12-B-E	108	16VEPF16	141	AG4F4-PV	96
10WSBF10-SS	153	12VF12-E	108	16VEPOF16	141	AG4F6	95
10WSDP-A	156	12VF12-SS	103	16VF16	103	AG4F6-PV	96
10WSF10	153	12VF12-SS-E	108	16VF16-B	103	AG4OF4	95
10WSF10-BOP	159	12VM12	105	16VF16-B-E	108	AG4OF4-PV	96
10WSF10-SS	153	12VM12-B	105	16VF16-E	108	AG4OF5	95
10WSF10-SS-BOP	159	12VM12-E	110	16VF16-SS	103	AG4OF5-PV	96
10WSFH10	155	12VM12-SS	105	16VF16-SS-E	108	AG6DC	96
10WSFP10	155	12VM12-SS-E	110	16VM16	105	AG6F6	95
10WSOF10	153	12VOF12	103	16VM16-B	105	AG6F6-PV	96
10WS-RKIT	157	12V-SKIT	113	16VM16-E	110	AG8DC	96
10WS-SKIT	157	12WBF12-B	149	16VM16-SS	105	AG8F8	95
12BOP-SKIT	157	12WBF12-B-HN	149	16VM16-SS-E	110	AG8F8-PV	96
12EF12-B	170	12WDP	151	16V-SKIT	113	AGE4F4-PV	96
12EF12-S	170	12WF12-B	149	16WSBF16	153	AGE4OF4-PV	96
12EM12-B	172	12WF12-B-HN	149	16WSBF16-SS	153	BR1BF1-B-E-7	63
12E-SKIT	174	12W-RKIT-V2	151	16WSDP-A	156	BR1BF2-B-E-7	63
12HBF12	73	12WSBF12	153	16WSF16	153	BR1F1-B-E-7	63
12HBF12-B	73	12WSBF12-SS	153	16WSF16-BOP	159	BR1F2-B-E-7	63
12HBF12-S	73	12WSDP-A	156	16WSF16-SS	153	BR1GM1-B-E-7	64
12HBF12-SS	73	12WSF12	153	16WSF16-SS-BOP	159	BR1GM2-B-E-7	64
12H-BRKIT	79	12WSF12-BOP	159	16WSFH16	155	BR1M1-B-E-7	64
12HDP-A	77	12WSF12-SS	153	16WSFP16	155	BR1M2-B-E-7	64
12HF10	73	12WSF12-SS-BOP	159	16WSOF16	153	BR1S1.25-B-E-7	64
12HF10-B	73	12WSFH12	155	16WS-RKIT	157	BR1S1.86-B-E-7	64
12HF10-S	73	12WSFP12	155	16WS-SKIT	157	BR1S2.83-B-E-7	64
12HF10-SS	73	12WSOF12	153	20HDP-A	77	CJ2BF2-B	40
12HF12	73	12WS-RKIT	157	20HF16	73	CJ2BF2-LG	40
12HF12-B	73	12WS-SKIT	157	20HF16-B	73	CJ2BF3-B	40
12HF12-S	73	16BOP-SKIT	157	20HF20	73	CJ2BF3-LG	40
12HF12-SS	73	16EF16-B	170	20HF24	73	CJ2BM2-B	41
12HOF10	73	16EF16-S	170	140030-10	114	CJ2BM2-LG	41
12HOF12	73	16EM16-B	172	140030-12	114	CJ2BM3-B	41
12H-RKIT	79	16E-SKIT	174	140030-16	114	CJ2BM3-LG	41
12H-SKIT	78	16HTBF16	122	140032-10	114	CJ2F2-B	40
12H-SRKIT	79	16HTF16	122	140032-12	114	CJ2F2-LG	40
12H-SSRKIT	79	16HTOF16	122	140032-16	114	CJ2F3-B	40
12HTBF12	122	16KBF16	89	A1F1-B	66	CJ2F3-LG	40
12HTF12	122	16KDP-A	92	A1M1-B	66	CJ2M2-B	41
12HTOF12	122	16KF16	89	A1S1-B	67	CJ2M2-LG	41
12KBF12	89	16K-SKIT	92	A2E2	67	CJ2M3-B	41
12KDP-A	92	16STBF12	134	A2E2-B	67	CJ2M3-LG	41
12KF12	89	16STBF16	134	A2F1-B	66	CJ3BF3	40
12K-SKIT	92	16STDP-A	136	A2F2	66	CJ3BF3-B	40
12VBF12	103	16STF12	134	A2F2-B	66	CJ3BF4	40
12VBF12-B	103	16STF16	134	A2M2	66	CJ3BF4-B	40
12VBF12-SS	103	16STF16-SS	134	A2M2-B	66	CJ3BM3	41
12VDP-A	112	16STOF12	134	A2S2	67	CJ3BM3-B	41
12VEPBF12	141	16STOF16	134	AG2DC	96	CJ3BM4	41
12VEPDP-A	144	16ST-SKIT	137	AG2F2	95	CJ3BM4-B	41
12VEPF12	141	16VBF16	103	AG2F2-PV	96	CJ3F3	40
12VEPF12-BOP	146	16VBF16-B	103	AG3DC	96	CJ3F3-B	40
12VEPFH12	143	16VBF16-SS	103	AG3F3	95	CJ3F4	40
12VEPFP12	143			AG3F3-PV	96		

Alpha Numeric Product Index

Part #	Page #	Part #	Page #	Part #	Page #	Part #	Page #
CJ3F4-B	40	CVV4FM2215	165	D3F4	22	E2BF2-B	171
CJ3M3	41	CVV4OF4	165	D3M2	25	E2F2	171
CJ3M3-B	41	CVV4OF5	165	D3M3	25	E2F2-B	171
CJ3M4	41	CVV6BF6	165	D3M3-B	25	E2F2-S	171
CJ3M4-B	41	CVV6DC	166	D3M3-S	25	E2M2	173
CM2F1	178	CVV6F6	165	D3M4	25	E2M2-B	173
CM2F1-B	178	CVV6FM2215	165	D3S2	27	E2M2-S	173
CM2F2	178	CVV8BF8	165	D3S3	27	E2S2	174
CM2F2-B	178	CVV8DC	166	D3S3-B	27	E2S2-B	174
CM2F3	178	CVV8F8	165	D3S3-S	27	E3BF3-B	171
CM2F3-B	178	CVV10BF10	165	D3S4	27	E3F3	171
CM2M1-B	178, 184	CVV10DC	166	D4B4	28	E3F3-B	171
CM2M1-B-L2.5	179	CVV10F10	165	D4BF4	22	E3F3-S	171
CM2M1-B-L4	179	D2B2	28	D4BM4	25	E3M3	173
CM2M1-B-L5.5	179	D2B2-B	28	D4F3	22	E3M3-B	173
CM2M2-B	178, 184	D2B3	28	D4F4	22	E3M3-S	173
CM2M2-B-L2.5	179	D2BF2	22	D4F4-B	22	E3S3	174
CM2M2-B-L4	179	D2BF3	22	D4F4-S	22	E3S3-B	174
CM2M2-B-L5.5	179	D2BM2	25	D4F6	22	E4BF4-B	171
CM2M2-B-L7	179	D2BM3	25	D4F6-B	22	E4F4	171
CM2M3-B	178, 184	D2E2	28	D-4HF4-S-FNS	75	E4F4-B	171
CM3F2	178	D2F1	22	D-4HF4-S-FSB	75	E4F4-S	171
CM3F2-B	178	D2F2	22	D-4HF4-SS-FNS	75	E4M4	173
CM3F3	178	D2F2-B	22	D-4HF4-SS-FSB	75	E4M4-B	173
CM3F3-B	178	D2F2-S	22	D4M2	25	E4M4-S	173
CM3M1-B-L2.5	179	D2F3	22	D4M3	25	E4S4	174
CM3M1-B-L4	179	D2F3-B	22	D4M4	25	E4S4-B	174
CM3M1-B-L5.5	179	D2F3-S	22	D4M4-B	25	E6BF6-B	171
CM3M1-B-L7	179	D2H2	28	D4M4-S	25	E6F6	171
CM3M2-B	178, 184	D2K3	28	D4M6	25	E6F6-B	171
CM3M2-B-L2.5	179	D2L3	28	D4S3	27	E6F6-S	171
CM3M2-B-L4	179	D2M1	25	D4S3-B	27	E6M6	173
CM3M2-B-L5.5	179	D2M1-B	25	D4S4	27	E6M6-B	173
CM3M2-B-L7	179	D2M1-S	25	D4S4-B	27	E6M6-S	173
CM3M2-B-L8.5	179	D2M2	25	D4S4-S	27	E6S6	174
CM3M2-B-L11.5	179	D2M2-B	25	D4S6	27	E6S6-B	174
CM3M3-B	178, 184	D2M2-S	25	D4S6-B	27	E8BF8-B	171
CM3M4-B	178, 184	D2M3	25	D6B6	28	E8F8	171
CM4F4-B	178	D2M3-B	25	D6F4	22	E8F8-B	171
CM4F6-B	178	D2M3-S	25	D6F6	22	E8F8-S	171
CM4M4-B	178, 184	D2S2	27	D6F8	22	E8M8	173
CM4M6-B	178, 184	D2S2.5	27	D6M4	25	E8M8-B	173
CNG8F8-S	86	D2S2-B	27	D6M6	25	E8M8-S	173
CNG8OM8-S	86	D2S2-S	27	D6M8	25	E8S8	174
CVV2BF2	165	D2S3	27	D6S4	27	E8S8-B	174
CVV2DC	166	D2S3-B	27	D6S6	27	E10F10	171
CVV2F2	165	D2S3-S	27	D6S8	27	E10F10-B	171
CVV2FM1415	165	D3B2	28	D-H4F4-S	76	E10F10-S	171
CVV3BF3	165	D3B3	28	D-H4F4-SS	76	E10M10	173
CVV3DC	166	D3B4	28	D-H4F4-SV-8	76	E10M10-B	173
CVV3F3	165	D3BF3	22	E1F1	171	E12F12	171
CVV3FM1615	165	D3BM3	25	E1F1-B	171	E12F12-B	171
CVV4BF4	165	D3F2	22	E1F1-S	171	E12F12-S	171
CVV4DC	166	D3F3	22	E1M1	173	E12M12	173
CVV4F4	165	D3F3-B	22	E1M1-B	173	E12M12-B	173
CVV4FM1815	165	D3F3-S	22	E1M1-S	173	E16F16	171

Part #	Page #	Part #	Page #	Part #	Page #	Part #	Page #
E16F16-B	171	H3BF3-SS	72	H10F10-S	74	HT2BF2	120
E16F16-S	171	H3DC	77	H10F10-SS	74	HT2DC	124
E16M16	173	H3DC-A	77	H12BF12	74	HT2F2	120
E16M16-B	173	H3F3	72	H12BF12-B	74	HT2OF3	120
EA4F3	176	H3F3-B	72	H12BF12-S	74	HT2-SKIT-V2	124
EA4F4	176	H3F3-BOP	81	H12BF12-SS	74	HT3BAND-B	118
F-1H-SKIT	78	H3F3-S	72	H12DC-A	77	HT3BAND-G	118
F-2E-SKIT	174	H3F3-SS	72	H12F10	74	HT3BAND-O	118
F-2H-SKIT	78	H3F3-SS-BOP	81	H12F10-B	74	HT3BAND-R	118
F-2V-SKIT	113	H3OF4	72	H12F10-S	74	HT3BAND-Y	118
F-3E-SKIT	174	H4BF4	72	H12F10-SS	74	HT3BF3	120
F-3H-SKIT	78	H4BF4-B	72	H12F12	74	HT3BF3-SS	120
F-3V-SKIT	113	H4BF4-S	72	H12F12-B	74	HT3BF4	120
F-4EA-SKIT	176	H4BF4-SS	72	H12F12-S	74	HT3BF4-SS	120
F-4E-SKIT	174	H4DC	77	H12F12-SS	74	HT3DC	124
F-4HF4-HV	75	H4DC-A	77	H12OF10	74	HT3F3	120
F-4H-SKIT	78	H4F4	72	H12OF12	74	HT3F3-SS	120
F-4N-SKIT	56	H4F4-B	72	H20DC-A	77	HT3F4	120
F-4P-SKIT	60	H4F4-BOP	81	H20F16	74	HT3F4-SS	120
F-4V-SKIT	113	H4F4-HV	75	H20F16-B	74	HT3M3	121
F-6E-SKIT	174	H4F4-S	72	H20F20	74	HT3M4	121
F-6H-SKIT	78	H4F4-SS	72	H20F24	74	HT3OF3	120
F-6V-SKIT	113	H4F4-SS-BOP	81	HS2BF2	84	HT3OF4	120
F-8E-SKIT	174	H4M6-S	74	HS2BF2-B	84	HT3OM3	121
F-8H-SKIT	78	H4OF5	72	HS2BF2-S	84	HT3OM4	121
F-8V-SKIT	113	H6BF6	72	HS2F2	84	HT3-SKIT-V2	124
F-10E-SKIT	174	H6BF6-B	72	HS2F2-B	84	HT4BAND-B	118
F-10-SKIT	78	H6BF6-S	72	HS2F2-S	84	HT4BAND-G	118
F-10V-SKIT	113	H6BF6-SS	72	HS3BF3	84	HT4BAND-O	118
F-12E-SKIT	174	H6DC	77	HS3BF3-B	84	HT4BAND-R	118
F-12H-SKIT	78	H6DC-A	77	HS3BF3-S	84	HT4BAND-Y	118
F-12V-SKIT	113	H6F6	72	HS3F3	84	HT4BF4	120
F-16E-SKIT	174	H6F6-B	72	HS3F3-B	84	HT4BF4-SS	120
F-16V-SKIT	113	H6F6-BOP	81	HS3F3-S	84	HT4BF6	120
F-H4F4-HV	75	H6F6-S	72	HS4BF4	84	HT4BF6-SS	120
H1DC	77, 139	H6F6-SS	72	HS4BF4-B	84	HT4DC	124
H1F1	72	H6F6-SS-BOP	81	HS4BF4-S	84	HT4F4	120
H1F1-B	72	H6OF6	72	HS4F4	84	HT4F4-SS	120
H1F1-S	72	H8BF8	72	HS4F4-B	84	HT4F6	120
H1F1-SS	72	H8BF8-B	72	HS4F4-S	84	HT4F6-SS	120
H10F2	72	H8BF8-S	72	HS6BF6	84	HT4JB5	122
H2BF2	72	H8BF8-SS	72	HS6BF6-B	84	HT4JB6	122
H2BF2-B	72	H8DC	77	HS6BF6-S	84	HT4M4	121
H2BF2-S	72	H8DC-A	77	HS6F6	84	HT4OF4	120
H2BF2-SS	72	H8F8	72	HS6F6-B	84	HT4OF5	120
H2DC	77	H8F8-B	72	HS6F6-S	84	HT4OF6	120
H2DC-A	77	H8F8-BOP	81	HS8BF8	84	HT4RB4	122
H2F2	72	H8F8-S	72	HS8BF8-B	84	HT4RB5	122
H2F2-B	72	H8F8-SS	72	HS8BF8-S	84	HT4RB6	122
H2F2-S	72	H8F8-SS-BOP	81	HS8F8	84	HT4-SKIT-V2	124
H2F2-SS	72	H8OF8	72	HS8F8-B	84	HT5BAND-B	118
H2M2	74	H10BF10	74	HS8F8-S	84	HT5BAND-G	118
H2M3	74	H10BF10-B	74	HT2BAND-B	118	HT5BAND-O	118
H2OF3	72	H10BF10-S	74	HT2BAND-G	118	HT5BAND-R	118
H3BF3	72	H10BF10-SS	74	HT2BAND-O	118	HT5BAND-Y	118
H3BF3-B	72	H10F10	74	HT2BAND-R	118	HT5BF6	120
H3BF3-S	72	H10F10-B	74	HT2BAND-Y	118		

Part #	Page #	Part #	Page #	Part #	Page #	Part #	Page #
HT5BF6-SS	120	HTE4F4	127	K2BF2	90	M2M3	37
HT5DC	124	HTE4F6	127	K2BF2-SS	90	M2S2	38
HT5F6	120	HTE4OF4	127	K2DC	91	M2S3	38
HT5F6-SS	120	HTE4OF5	127	K2F1	90	M3F3	36
HT5OF5	120	HTE4OF6	127	K2F2	90	M3M3	37
HT5OF6	120	HTE5BF6	127	K2F2-SS	90	M3S3	38
HT5-SKIT-V2	124	HTE5F6	127	K2OF2	90	N3BM4	53
HT6BAND-B	118	HTE5OF5	127	K3BF3	90	N3CS4	54
HT6BAND-G	118	HTE5OF6	127	K3BF3-SS	90	N3JM4-ZLS	53
HT6BAND-O	118	HTE6BF6	127	K3DC	91, 111	N3M4	53
HT6BAND-R	118	HTE6BF8	127	K3F3	90	N4BF3	51
HT6BAND-Y	118	HTE6F6	127	K3F3-SS	90	N4BF4	51
HT6BF6	120	HTE6F8	127	K3OF3	90	N4BF4-B	51
HT6BF6-SS	120	HTE6OF6	127	K4-B-DC	91	N4BF6	51
HT6BF8	120	HTE6OF8	127	K4BF4	90	N4BF6-B	51
HT6BF8-SS	120	HTE8BF8	127	K4BF4-SS	90	N4BF8	51
HT6DC	124	HTE8BF10	127	K4DC	91	N4BF8-B	51
HT6F6	120	HTE8F8	127	K4F4	90	N4BM3	53
HT6F6-SS	120	HTE8F10	127	K4F4-SS	90	N4BM4	53
HT6F8	120	HTE8OF8	127	K4F6	90	N4BM4-B	53
HT6F8-SS	120	HTE8OF10	127	K4-G-DC	91	N4BM4-LS	53
HT6OF5	120	IH4F4	97	K4-O-DC	91	N4BM6	53
HT6OF6	120	J2B2	34	K4OF4	90	N4BM6-B	53
HT6OF8	120	J2B3	34	K4OF5	90	N4BM6-LS	53
HT6-SKIT-V2	124	J2F1	31	K4-R-DC	91	N4BM8	53
HT8BAND-B	118	J2F2	31	K4-Y-DC	91	N4BM8-B	53
HT8BAND-G	118	J2F2-B	31	K6BF6	90	N4DC	56
HT8BAND-O	118	J2F3	31	K6BF6-SS	90	N4DC-B	56
HT8BAND-R	118	J2M1	32	K6DC	91	N4F3	51
HT8BAND-Y	118	J2M2	32	K6F6	90	N4F3-B	51
HT8BF8	120	J2M2-B	32	K6F6-SS	90	N4F4	51
HT8BF8-SS	120	J2M3	32	K6OF6	90	N4F4-B	51
HT8BF10	120	J2S2	33	K8BF8	90	N4F4-B-LS	51
HT8BF10-SS	120	J2S3	33	K8BF8-SS	90	N4F6	51
HT8DC	124	J3B3	34	K8DC	91	N4F6-B	51
HT8F8	120	J3F2	31	K8F8	90	N4F6-B-LS	51
HT8F8-SS	120	J3F3	31	K8F8-SS	90	N4F6-LS	51
HT8F10	120	J3F4	31	K8OF8	90	N4F6-S	51
HT8F10-SS	120	J3M2	32	K10BF10	90	N4F6-SS	51
HT8OF8	120	J3M3	32	K10DC-A	92	N4F6-ZLS	51
HT8OF10	120	J3M4	32	K10F10	90	N4F8	51
HT8-SKIT-V2	124	J3S2	33	K12BF12	90	N4F8-B	51
HT12BF12	122	J3S3	33	K12DC-A	92	N4F8-SS	51
HT12F12	122	J3S4	33	K12F12	90	N4M3	53
HT12OF12	122	J4B4	34	K16BF16	90	N4M3-B	53
HT16BF16	122	J4F3	31	K16DC-A	92	N4M4	53
HT16F16	122	J4F4	31	K16F16	90	N4M4-B	53
HT16OF16	122	J4F6	31	L2F2	45	N4M4-B-LS	53
HT49OF3	123	J4M3	32	L2M2	46	N4M4-LS	53
HT49OF4	123	J4M4	32	M2B2	38	N4M6	53
HTE3BF4	127	J4M6	32	M2F2	36	N4M6-B	53
HTE3F3	127	J4S3	33	M2F2-B	36	N4M6-B-LS	53
HTE3F4	127	J4S4	33	M2F3	36	N4M6-LS	53
HTE3OF4	127	J4S6	33	M2M1	37	N4M6-S	53
HTE4BF4	127	JD4F4	97	M2M2	37	N4M6-S-LS	53
HTE4BF6	127	JD4OF4	97	M2M2-B	37	N4M6-SS	53

Part #	Page #	Part #	Page #	Part #	Page #	Part #	Page #
N4M6-ZLS.....	52	P4M4.....	59	SCVS10.....	69	ST8F8-V2.....	136
N4M8.....	53	P4M4-B.....	59	SCVS12.....	69	ST8F10.....	135
N4M8-B.....	53	P4M6.....	59	SCVS16.....	69	ST8F10-SS.....	135
N4M8-SS.....	53	P4M6-9.....	59	SCVS24.....	69	ST8F10-V2.....	136
N4S3.....	54	P4M6-B.....	59	SCVX12.....	69	ST8OF8.....	135
N4S3-B.....	54	P4M6-S.....	59	SHD2F1.....	43	ST8OF10.....	135
N4S4.....	54	P4M8.....	59	SHD2F2.....	43	ST8-SKIT.....	137
N4S4-B.....	54	P4M8-B.....	59	SHD2M1.....	43	ST16BF12.....	136
N4S4-B-LS.....	55	P-4V-SKIT.....	113	SHD2M2.....	43	ST16BF16.....	136
N4S4-B-LS-WF.....	55	P-6E-SKIT.....	174	SHD2S2.....	44	ST16DC-A.....	136
N4S4-B-WF.....	55	P-6H-SKIT.....	78	SHD2S3.....	44	ST16F12.....	136
N4S4-LS.....	55	P-6V-SKIT.....	113	SHD4F3.....	43	ST16F16.....	136
N4S4-LS-WF.....	55	P-8E-SKIT.....	174	SHD4M3.....	43	ST16F16-SS.....	136
N4S4-WF.....	55	P-8H-SKIT.....	78	SHD4M4.....	43	ST16OF12.....	136
N4S6.....	54	P-8V-SKIT.....	113	SHD4S3.....	44	ST16OF16.....	136
N4S6-B.....	54	P-10E-SKIT.....	174	SHD4S4.....	44	ST16-SKIT.....	137
N4S6-B-LS.....	55	P-10-SKIT.....	78	ST2BF2.....	135	T2DC.....	162
N4S6-B-LS-WF.....	55	P-10V-SKIT.....	113	ST2BF2-SS.....	135	T2F2.....	161
N4S6-B-WF.....	55	P-12E-SKIT.....	174	ST2DC-A.....	136	T3DC.....	162
N4S6-LS.....	55	P-12H-SKIT.....	78	ST2F2.....	135	T3F3.....	161
N4S6-LS-WF.....	55	P-12V-SKIT.....	113	ST2F2-SS.....	135	T3F3-PV.....	162
N4S6-S.....	54	P-16E-SKIT.....	174	ST2-SKIT.....	137	T3F3-SS.....	161
N4S6-S-LS.....	55	P-16V-SKIT.....	113	ST3BF3.....	135	T3F3-SS-PV.....	162
N4S6-SS.....	54	PD1F1.....	138	ST3BF3-SS.....	135	TD4.5DC-A.....	168
N4S6-S-WF.....	55	PD1F2.....	138	ST3BF4.....	135	TD4DC-A.....	168
N4S6-WF.....	55	PD1M1.....	139	ST3BF4-SS.....	135	TD4F4-SS.....	168
N4S6-ZLS.....	55	PD1M2.....	139	ST3DC-A.....	136	TD4PF4.5-SS.....	168
N4S8.....	54	PD1OM2.....	139	ST3F2.....	135	TR3BF3.....	116
N4S8-B.....	54	PD1OM3.....	139	ST3F3.....	135	TR3F3.....	116
N4S8-S.....	54	SCVH6.....	69	ST3F3-SS.....	135	TR4BF4.....	116
N4S8-SS.....	54	SCVH8.....	69	ST3F4.....	135	TR4F4.....	116
NK2BF2.....	61	SCVH10.....	69	ST3F4-SS.....	135	TR6BF6.....	116
NK2BM2.....	62	SCVH12.....	69	ST3-SKIT.....	137	TR6F6.....	116
NK2F2.....	61	SCVH16.....	69	ST4BF4.....	135	TR8BF8.....	116
NK2M2.....	62	SCVH24.....	69	ST4BF4-SS.....	135	TR8F8.....	116
NK2S2.....	62	SCVJ6.....	69	ST4DC-A.....	136	V2BF2.....	102
P-1H-SKIT.....	78	SCVL2.....	69	ST4F4.....	135	V2BF2-B.....	102
P-2E-SKIT.....	174	SCVL3.....	69	ST4F4-SS.....	135	V2BF2-B-E.....	109
P-2H-SKIT.....	78	SCVL6.....	69	ST4OF4.....	135	V2BF2-E.....	109
P-2V-SKIT.....	113	SCVL8.....	69	ST4-SKIT.....	137	V2BF2-SS.....	102
P-3E-SKIT.....	174	SCVL10.....	69	ST6BF6.....	135	V2BF2-SS-E.....	109
P-3H-SKIT.....	78	SCVL12.....	69	ST6BF6-SS.....	135	V2-BRKIT.....	114
P-3V-SKIT.....	113	SCVL16.....	69	ST6DC-A.....	136	V2DC.....	111
P-4EA-SKIT.....	176	SCVL24.....	69	ST6F6.....	135	V2DC-A.....	112
P-4E-SKIT.....	174	SCVM3.....	69	ST6F6-SS.....	135	V2F1.....	102
P4F3.....	58	SCVM4.....	69	ST6OF6.....	135	V2F2.....	102
P4F4.....	58	SCVM6.....	69	ST6-SKIT.....	137	V2F2-B.....	102
P4F4-B.....	58	SCVM8.....	69	ST8BF8.....	135	V2F2-B-E.....	109
P4F6.....	58	SCVM10.....	69	ST8BF8-SS.....	135	V2F2-E.....	109
P4F6-9.....	58	SCVM12.....	69	ST8BF8-V2.....	136	V2F2-SS.....	102
P4F6-B.....	58	SCVM16.....	69	ST8BF10.....	135	V2F2-SS-E.....	109
P4F6-S.....	58	SCVR6.....	69	ST8BF10-SS.....	135	V2JM2.....	107
P4F8.....	58	SCVS3.....	69	ST8DC-A.....	136	V2M1.....	106
P4F8-B.....	58	SCVS4.....	69	ST8DC-A-V2.....	136	V2M2.....	106
P-4H-SKIT.....	78	SCVS6.....	69	ST8F8.....	135	V2M2-B.....	106
P4M3.....	59	SCVS8.....	69	ST8F8-SS.....	135	V2M2-B-E.....	111

Part #	Page #	Part #	Page #	Part #	Page #	Part #	Page #
V2M2-E	111	V4-SSRKIT	114	V10BF10-SS-E	109	VEP3F4-BOP	146
V2M2-SS	106	V6BF6	102	V10DC-A	112	VEP3OF4	142
V2M2-SS-E	111	V6BF6-B	102	V10F10	104	VEP4BF4	142
V2OF2	102	V6BF6-B-E	109	V10F10-B	104	VEP4BF6	142
V2-RKIT	114	V6BF6-E	109	V10F10-B-E	109	VEP4DC-A	144
V2-SSRKIT	114	V6BF6-SS	102	V10F10-E	109	VEP4F4	142
V3BF3	102	V6BF6-SS-E	109	V10F10-SS	104	VEP4F4-BOP	146
V3BF3-B	102	V6-BRKIT	114	V10F10-SS-E	109	VEP4F6	142
V3BF3-B-E	109	V6DC	111	V10JM10	107	VEP4OF4	142
V3BF3-E	109	V6DC-A	112	V10M10	106	VEP4OF5	142
V3BF3-SS	102	V6F6	102	V10M10-B	106	VEP4OF6	142
V3BF3-SS-E	109	V6F6-B	102	V10M10-E	111	VEP6BF6	142
V3-BRKIT	114	V6F6-B-E	109	V10M10-SS	106	VEP6DC-A	144
V3DC	111	V6F6-E	109	V10M10-SS-E	111	VEP6F6	142
V3DC-A	112	V6F6-SS	102	V10OF10	104	VEP6F6-BOP	146
V3F3	102	V6F6-SS-E	109	V12BF12	104	VEP6FH6	143
V3F3-B	102	V6JM6	107	V12BF12-B	104	VEP6FP6	143
V3F3-B-E	109	V6M6	106	V12BF12-SS	104	VEP6OF6	142
V3F3-E	109	V6M6-B	106	V12DC-A	112	VEP8BF8	142
V3F3-SS	102	V6M6-B-E	111	V12F12	104	VEP8DC-A	144
V3F3-SS-E	109	V6M6-E	111	V12F12-B	104	VEP8F8	142
V3F4	102	V6M6-SS	106	V12F12-B-E	109	VEP8F8-BOP	146
V3JM3	107	V6M6-SS-E	111	V12F12-E	109	VEP8F8-SS	142
V3M3	106	V6OF6	102	V12F12-SS	104	VEP8FH8	143
V3M3-B	106	V6-RKIT	114	V12F12-SS-E	109	VEP8FP8	143
V3M3-B-E	111	V6-SSRKIT	114	V12M12	106	VEP8OF8	142
V3M3-E	111	V8BF8	102	V12M12-B	106	VEP10BF10	142
V3M3-SS	106	V8BF8-B	102	V12M12-E	111	VEP10DC-A	144
V3M3-SS-E	111	V8BF8-B-E	109	V12M12-SS	106	VEP10F10	142
V3OF3	102	V8BF8-E	109	V12M12-SS-E	111	VEP10F10-BOP	146
V3-RKIT	114	V8BF8-SS	102	V12OF12	104	VEP10FH10	143
V3-SSRKIT	114	V8BF8-SS-E	109	V16BF16	104	VEP10FP10	143
V4BF4	102	V8-BRKIT	114	V16BF16-B	104	VEP10OF10	142
V4BF4-B	102	V8DC	111	V16BF16-SS	104	VEP12BF12	142
V4BF4-B-E	109	V8DC-A	112	V16DC-A	112	VEP12DC-A	144
V4BF4-E	109	V8F8	102	V16F16	104	VEP12F12	142
V4BF4-SS	102	V8F8-B	102	V16F16-B	104	VEP12F12-BOP	146
V4BF4-SS-E	109	V8F8-B-E	109	V16F16-B-E	109	VEP12FH12	143
V4-BRKIT	114	V8F8-E	109	V16F16-E	109	VEP12FP12	143
V4DC-A	112	V8F8-SS	102	V16F16-SS	104	VEP12OF12	142
V4F4	102	V8F8-SS-E	109	V16F16-SS-E	109	VEP16BF16	142
V4F4-B	102	V8JM8	107	V16M16	106	VEP16DC-A	144
V4F4-B-E	109	V8M8	106	V16M16-B	106	VEP16F16	142
V4F4-E	109	V8M8-B	106	V16M16-E	111	VEP16OF16	142
V4F4-SS	102	V8M8-B-E	111	V16M16-SS	106	W2DC	151
V4F4-SS-E	109	V8M8-E	111	V16M16-SS-E	111	W2F1-B	150
V4F6	102	V8M8-SS	106	VEP2BF2	142	W3DC	151
V4JM4	107	V8M8-SS-E	111	VEP2DC-A	144	W3F2-B	150
V4M4	106	V8OF8	102	VEP2F2	142	W3F3-B	150
V4M4-B	106	V8-RKIT	114	VEP2OF3	142	W6BF4-B	150
V4M4-B-E	111	V8-SSRKIT	114	VEP3BF3	142	W6BF6-B	150
V4M4-E	111	V10BF10	104	VEP3BF4	142	W6-BMF	150
V4M4-SS	106	V10BF10-B	104	VEP3DC-A	144	W6DC	151
V4M4-SS-E	111	V10BF10-B-E	109	VEP3F3	142	W6F4-B	150
V4OF4	102	V10BF10-E	109	VEP3F3-BOP	146	W6F6-B	150
V4-RKIT	114	V10BF10-SS	104	VEP3F4	142	W6-RKIT-V2	151



Part #	Page #	Part #	Page #	Part #	Page #	Part #	Page #
W8BF8-B	150	WS12FP12	155				
W8-BMF	150	WS12OF12	154				
W8DC	151	WS16BF16	154				
W8F8	150	WS16BF16-SS	154				
W8F8-B	150	WS16DC-A	156				
W8-RKIT-V2	151	WS16F16	154				
W10BF10-B	150	WS16F16-BOP	159				
W10-BMF	150	WS16F16-SS	154				
W10DC	151	WS16F16-SS-BOP	159				
W10F10-B	150	WS16FH16	155				
W10-RKIT-V2	151	WS16FP16	155				
W12BF12-B	150	WS16OF16	154				
W12-BMF	150	XK2F2	131				
W12DC	151	XK3F3	131				
W12F12-B	150						
W12-RKIT-V2	151						
WS6BF6	154						
WS6BF6-SS	154						
WS6DC-A	156						
WS6F4	154						
WS6F4-BOP	159						
WS6F6	154						
WS6F6-BOP	159						
WS6F6-SS	154						
WS6F6-SS-BOP	159						
WS6FH6	155						
WS6FP6	155						
WS6OF6	154						
WS8BF8	154						
WS8BF8-SS	154						
WS8DC-A	156						
WS8F8	154						
WS8F8-BOP	159						
WS8F8-SS	154						
WS8F8-SS-BOP	159						
WS8FH8	155						
WS8FP8	155						
WS8OF8	154						
WS10BF10	154						
WS10BF10-SS	154						
WS10DC-A	156						
WS10F10	154						
WS10F10-BOP	159						
WS10F10-SS	154						
WS10F10-SS-BOP	159						
WS10FH10	155						
WS10FP10	155						
WS10OF10	154						
WS12BF12	154						
WS12BF12-SS	154						
WS12DC-A	156						
WS12F12	154						
WS12F12-BOP	159						
WS12F12-SS	154						
WS12F12-SS-BOP	159						
WS12FH12	155						

Glossary of Terms

Absolute Pressure: The sum of gauge and atmospheric pressure.

Accidental Disconnection: Disconnection of a coupling while in operation due to failure of the coupling mechanism (a.k.a. unintentional disconnection).

Accumulator: A container in which fluid is stored under pressure as a source of reserve fluid power.

Aeration: Air in a fluid.

Air Inclusion: The air forced into the system during the connection of a quick disconnect coupling.

Atmospheric Pressure: Pressure exerted by the atmosphere at any specific location. Sea level pressure is approximately 14.7 PSI.

Backpressure: Refers to pressure existing on the discharge side of a system.

Bar: An international standard unit of pressure equal to 100,000 Pascals, approximately 14.5 PSI.

Blind-Mate: A coupling that can be automatically connected without human intervention and without visibility.

Break-Away: Automatic disconnection of a coupling when an axial separation force is applied.

Brinelling: Dimples or grooves worn into the shoulder of a male half by locking balls in the female half. This is terminology stemming from a test that is done to evaluate the hardness of metals. Swedish metallurgist, Johan August Brinell (1849-1925), developed a hardness test that measured the relative hardness of metals and alloys by forcing a 10 mm hard steel ball into a test piece with a 3,000 kg load for 30 seconds. After completion of the test, the surface area of the resulting indentation was measured.

Burst Pressure: The pressure at which a device loses the capability to retain pressure.

Case Hardening: Hardening the entire surface of a low carbon steel to a specific depth.

Cavitation: A localized gaseous condition within a liquid stream which occurs where the pressure is reduced to the vapor pressure.

Charge Pressure: The pressure at which replenishing fluid is forced into the hydraulic system (above atmospheric pressure).

Check Valve: A valve which permits flow of media in one direction only.

Cold Flow: Continued deformation under load.

Connect Under Pressure: The ability to connect coupling halves with internal line pressure applied to either both sides or one side.

Contamination: Any material foreign to a media that has a harmful effect on its performance in a system.

Coupling, Female Half: a.k.a. coupler, socket, receiver.

Coupling, Male Half: a.k.a. nipple, plug, adapter.

Coupling, Quick Disconnect: A component that can quickly join or separate a fluid line without the use of tools or special devices.

Differential Pressure: (DP) The difference in pressure between any two points of a system or a component, also known as Delta-P or pressure drop.

Drybreak Coupling: A coupling that allows connection and disconnection without spillage or air inclusion (a.k.a. flushface, flat face, no-spill.)

Double-Acting Sleeve: Permits push-to-connect and pull-to-connect convenience when female half is mounted on the sleeve.

Dust Cap: Dust or dirt repelling enclosure for the plug.

Dust Plug: Dust or dirt repelling enclosure for the coupler.

Dynamic Pressure: Pressure that, once it is released, is able to be immediately replenished.

Flow Checking: Occurs when a valve closes during flow conditions, such as when quickly lowering a heavy implement (a.k.a. check off, back checking, lock-up).

Flush Position (valve): A no-spill valve that allows connection and disconnection without spillage or air inclusion. (a.k.a. flushface, drybreak, no-spill).

Force to Connect: Axial and/or rotational force required to make a complete connection.

Force to Disconnect: The reverse of the above.

GPM: Acronym for gallons per minute, a measure of flow.

Leakage: The media that is unintentionally released from a coupling due to component failure or retention weaknesses.

LPM: Acronym for liters per minute, a measure of flow.

Induction Hardening: Hardening of a localized area of medium or high carbon steel.

Operating Pressure: The pressure at which a system is operated (a.k.a. working pressure).

Peak Pressure: Maximum momentary pressure encountered in the operation of a component (a.k.a. pressure spike, surge pressure.)

Pressure Cap: A cap that incorporates a seal capable of withstanding the rated pressures on the male half.

Pressure Impulse Test: Subjecting a component to a specified pressure at a specific rate of increase or decrease for a specified time limit and cycle.

Proof Pressure: The nondestructive test pressure in excess of the maximum rated operating pressure, generally 1.5 times the standard operating pressure.

PSI: Acronym for pounds per square inch, a measure of pressure.

Push to Connect: Locking arrangement that permits one-handed connection by pushing the plug into the coupler (a.k.a. automatic sleeve, automatic collar, automatic connection).

Rotation: The act of spinning the coupler and plug in opposite directions in a continuous manner beyond 360°.

Single Acting Sleeve: Making connection requires manually pulling female sleeve back, inserting the male tip (a.k.a. semi-auto sleeve, manual sleeve)

Sleeve Lock: A coupling arrangement that provides an additional lock that must be actuated before locking sleeve can be retracted (a.k.a. pin-lock, locking sleeve).

Spillage: The fluid released from the system due to disconnection of a quick disconnect coupling. This is the fluid trapped between the mating seal and the valve seal of the coupling halves.

Static Pressure: Pressure that, once released, is not able to be immediately replenished.

Surge Flow: A rapid increase in fluid flow.

Swivel: The act of spinning the coupler and plug in opposite directions to a degree that is less than 360°.

Thermal Build-Up: Pressure caused by expansion of a media due to heat from an external source such as sunlight (a.k.a. thermal expansion).

Trapped Pressure: Pressurized fluid trapped behind a closed coupling valve.

Turbulence: Is the condition where the media does not move smoothly parallel to the flow direction. Turbulent flow is caused by abrupt changes in direction, changes of cross-section, or by high velocity. The result is increased friction, which generates heat, decreases operating pressure, and wastes power.

Twist Lock: A locking arrangement that requires a rotational actuation to unlock the mating halves.

Vacuum: Partially or completely exhausted of air, gas, or other media to create a negative pressure. Theoretically, a perfect vacuum would be measured as 30 inches of mercury, but that is unattainable. The true perfect vacuum is 29.7 inches of mercury.

F - 4 H F 4 - B - E - LS - 7

Body Size

1	1/8"
1.25	4mm
1.5	3/16"
1.88	6mm
2	1/4"
2.5	5/16"
2.83	9mm
3	3/8"
4	1/2"
5	5/8"
6	3/4"
8	1"
10	1-1/4"
12	1-1/2"
16	2"
20	2-1/2"
24	3"

End Size

1	1/8"
1.25	4mm
1.5	3/16"
1.88	6mm
2	1/4"
2.5	5/16"
2.83	9mm
3	3/8"
4	1/2"
5	5/8"
6	3/4"
8	1"
10	1-1/4"
12	1-1/2"
16	2"
20	2-1/2"
24	3"

Materials

S	303 stainless steel
SS	316 stainless steel
A	aluminum
B	brass

Standard material is steel.
No designation is necessary for standard steel configurations.

Valve Options

SSV	316 SS valve
SV	303 SS valve
BTV	Brass tube valve
BV	Brass valve
E	Unvalved (no valve)
HV	Heavy-duty valve
PV	Poppet valve
RV	Prong valve
TV	Tube valve
V	Valved
VA	Valve actuator

Seals

H	Aflas™
C	Celazole back-up
CZ	Chemrez
P	EPDM
PS	EPDM (steam)
D	FDA FKM
F	FKM
FS	Fluorosilicone
JF	Hydrocarbon fuel Nitrile
K4	Kalrez® 4079
K6	Kalrez® 6375
K7	Kalrez® 7075
M	Military low temp Nitrile
E	Neoprene
M1	Nitrile (FDA)
T	PTFE
TS	PTFE / Silicone
S	Silicone
U	Urethane

Standard seal is Nitrile. No designation is necessary for standard Nitrile seal configurations.

Product Series

T	10K Threaded
AG	Agricultural Interchange Hydraulic
M	ARO 210/310 Interchange
J	Automotive Interchange
N	Bowes Interchange
A	Compact
CJ	European High Flow Interchange
CVV	European Screw Together
ST	Heavy-Duty Flushface
WS	Heavy-Duty Wingstyle
WS-BOP	Heavy-Duty Wingstyle Blow Out Preventer
TD	High Pressure Couplings
DF	Industrial Interchange Pneumatic
HTZ	ISO16028 Connect Under Pressure Coupler
HTE	ISO16028 Connect Under Pressure Plug
HT	ISO16028 Flushface Interchange
K	ISO-A Mobile Interchange
H	ISO-B Industrial Interchange
HS	ISO-B Steam Interchange
NK	Japanese Industrial Interchange
L	Lincoln Long-Stem Interchange
V	MIL-C-51234
CM	Mold Coolant Interchange
SHD	Rectus 17/Schrader Interchange
BR	Rectus 21 Interchange
SCV	Safety Check Valve
E	Straight-Through Pressure Wash Interchange
EA	Straight-Through Water-Blast Interchange
TR	TEMA European Interchange
P	Thor Interchange
U	Universal Pneumatic Combo-Couplers
VEP-BOP	VEP Blow out Preventer Interchange
VEP	VEP Hydraulic Interchange
W	Wingstyle Interchange
XK	10K Flushface

End Connection

4B	45° Push-loc barb
4S	45° hose barb
9B	90° Push-loc barb
9S	90° hose barb
RB	Bulkhead ORFS
FH	Code 62 flange head
FP	Code 62 flange pad
CS	Collar hose barb
JF	Female 37° JIC
BF	Female BSPP
FM	Female metric
PF	Female MP threads
F	Female NPT(F)
OF	Female ORB
S	Hose barb
JM	Male 37° JIC
GM	Male BSPP
BM	Male BSPT
JB	Male bulkhead 37° JIC
MM	Male metric
M	Male NPT(F)
OM	Male ORB
RM	Male ORFS
MBM	Metric bulkhead
B	Push-loc barb
P	Tube fitting

Sleeve Options

HNS	303 SS hex nut sleeve
XLS	303 SS locking sleeve
XS	303 SS sleeve
YLS	316 SS locking sleeve
YS	316 SS sleeve
PB	Automatic ball latch
PL	Automatic latch pin
BFS	Brass flanged sleeve
BLS	Brass locking sleeve
BS	Brass sleeve
FLS	Flanged locking sleeve
FNS	Flanged nylon sleeve
FS	Flanged sleeve
HN	Hex nut sleeve
LS	Locking sleeve
NLS	No locking sleeve
FSB	Silicone fryer boot
ZFS	Steel flanged sleeve
ZLS	Steel locking sleeve
ZS	Steel sleeve
TP	Tangle prevention

Other Options

4	Black oxide plating
7	Bright nickel plating
11	Chrome over nickel
8	Electroless nickel plating
HL	Extended hex
BMF	Flange mount bracket
L##	Length
C1	Oxygen clean
9	PTFE coating
10	Standard nickel plating
WF	Wrench flats

To Designate Couplers
Body size numerical designation precedes coupling series alpha designation.
Example: 2HF2 (1/4" ISO-B Coupler)

To Designate Plugs
Coupling series alpha designation precedes body size numerical designation.
Example: H2F2 (1/4" ISO-B Plug)

Aflas™ is a trademark of Asahi Glass Limited
Kalrez® is a trademark of Dupont Polymers, Inc.
Teflon® is a trademark of The Chemours Company FC, LLC
Viton® is a trademark of The Chemours Company FC, LLC

 Many variations of the part numbers contained within this guide can be ordered utilizing the format shown above. However, some variations may require minimum order quantities, longer lead times, and/or price adjustments based upon the uniqueness of construction. Please contact your Dixon Quick Coupling representative for details regarding your particular coupling configuration.

Limited Warranty

DIXON VALVE AND COUPLING COMPANY, LLC (herein called "Dixon") warrants the products described herein and manufactured by Dixon to be free from defects in material and workmanship for a period of one (1) year from date of shipment by Dixon under normal use and service. Its sole obligation under this warranty being limited to repairing or replacing, as hereinafter provided, at its option any product found to Dixon's satisfaction to be defective upon examination by it, provided that such product shall be returned for inspection to Dixon's factory within three (3) months after discovery of the defect. The repair or replacement of defective products will be made without charge for parts or labor. This warranty shall not apply to: (a) parts or products not manufactured by Dixon, the warranty of such items being limited to the actual warranty extended to Dixon by its supplier; (b) any product that has been subject to abuse, negligence, accident, or misapplication; (c) any product altered or repaired by others than Dixon; and (d) to normal maintenance services and the replacement of service items (such as washers, gaskets, and lubricants) made in connection with such services. To the extent permitted by law, this limited warranty shall extend only to the buyer and any other person reasonably expected to use or consume the goods who is injured in person by any breach of the warranty. No action may be brought against Dixon for an alleged breach of warranty unless such action is instituted within one (1) year from the date the cause of action accrues. This limited warranty shall be construed and enforced to the fullest extent allowable by applicable law.

Other than the obligation of Dixon set forth herein, Dixon disclaims all warranties, express or implied, including but not limited to any implied warranties of merchantability or fitness for a particular purpose, and any other obligation or liability. The foregoing constitutes Dixon's sole obligation with respect to damages, whether direct, incidental, or consequential, resulting from the use or performance of the product.

Some products and sizes may be discontinued when stock is depleted or may require a minimum quantity for ordering.

Limits of Liability

This catalog is intended as a product offering. It is not intended to be a user or technical manual. Information in this catalog is subject to change without notice. All users and distributors of products sold through this catalog should contact Dixon with questions of use, compatibilities, coupling procedures, and life of product. Our full-time engineering and test staff are always available to recommend uses and to assist distributors and users with any questions.



Safety



Safety logos, which appear throughout our catalog, are used as a reminder that the user should carefully review for the appropriateness of the product for the media, application, and environment in which it will be used.

NOTE: Because of the health hazards associated with contamination and lead content in drinking water systems, Dixon couplings, unless otherwise specifically approved, are not recommended for potable water service and should not be used in applications where drinking water will contact the wetted surfaces of the coupling.

All Dixon products are shipped in cartons with the following warning:

"WARNING: This product contains lead, a chemical known to the State of California to cause cancer and birth defects or other reproductive harm."

Trademarks

Delrin® and Zytel® are registered trademarks of E.I. duPont Nemours and Company.

Kalrez® is a registered trademark of DuPont Dow Elastomers.

All other trademarks appearing in the Dixon illustrated price list are the property of their respective owners.

Copyright

Copyright © 2022 by Dixon Valve and Coupling, LLC

All rights reserved. This book is copyrighted material. Use, reproduction or copying of it by anyone other than Dixon® is strictly forbidden without its express written consent.

NOTE: Reasonable care has been taken in preparing this catalog. Dixon Valve & Coupling Company, LLC reserves the right to make corrections.

